



MACH-D

High-Performance D-Sub Connectors
for Use in Harsh Environments

- Precision machined shell provides EMI shielding protection
- Grounding strip provides excellent electromagnetic compatibility (EMC)
- Mechanically rugged machined shell protects against shock, vibration, and impact
- IP67 configurations protect against fluid and dust ingress
- High-performance M24308 intermateable



Positronic[®]
an Amphenol company

THE SCIENCE OF **CERTAINTY**[®]

M020 Rev A2 23/02



Positronic[®]

an Amphenol company

Positronic builds premium D-Sub connectors for a wide variety of global industries. But every product delivers the same outcome: Certainty. That's our master spec, our driving purpose.

We believe in the people who are advancing our world and making it a better place, those who are realizing new discoveries, developing technologies that help humans connect, and expanding commerce to advance economies. That is why we are serious about developing high-reliability interconnect solutions – because failure is not an option for critical systems, they must perform.

From deep space discovery to medical breakthroughs, Positronic delivers *The Science of Certainty*.

WHAT CAN YOU BE CERTAIN ABOUT?

- Failsafe product performance
- Maximum design flexibility
- Leading levels of energy efficiency and temperature control
- Responsive, knowledgeable support

**THE SCIENCE
OF CERTAINTY**[®]

TABLE OF CONTENTS

Overview

Family Overview	2
Plating Options	3
New Accessories & Features	4
M24308 at a Glance	5
Layouts	6-8
Temperature Rise Curves	9-10

MCD Standard Density

Overview & Tech Specs	11-12
Shell Dimensions	13
Contact Terminations	14
Create a Part	15
Additional Options	16

MCDD High Density

Overview & Tech Specs	17-18
Shell Dimensions	19
Contact Terminations	20
Create a Part	21
Additional Options	22

MCBX Combo-D

Overview & Tech Specs	23-24
Shell Dimensions	25
Contact Terminations	26-27
Create a Part	28
Additional Options	29

Removable Contacts

Size 20 & 22 Contacts	30
Size 8 Contacts - Power, High Voltage, and Coax	31

Accessories

Backshells & Boardlocks	32
Panel Mount Sealing Flange	33
Mounting Options	34
Locking Systems	35
Mounting Hole for Angle Bracket	35

Test Data

MCD, MCDD and MCBX Test Data	36
------------------------------	----

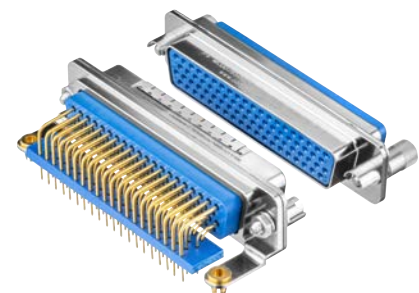



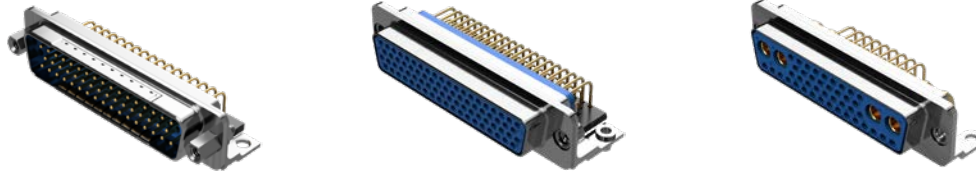

Positronic MACH-D connectors are built with precision machined shells that provide superior EMI shielding. EMI shielding protects against electronic disruptions, guarding against data loss, and defending against system failure. The MACH-D design and manufacturing process removes these

worries and allows the connector to exceed our customers' needs for quality and reliability. The MACH-D offers standard and high density signal contact arrangements as well as hybrid versions, which combine power and signal in a single connector body. A wide variety of accessories are also available.



	MCD	MCDD	MCBX
Shell sizes	1 to 5	1 to 6	
Shell material	Machined aluminum, stainless steel		
Shell finish	Electroless nickel, passivated stainless steel, cadmium, chemical conversion coating		
Contact size	#20	#22	#8, #20
Current rating	Up to 17A	Up to 12A	Up to 75A
Female contact design	PosiBand® Closed Entry (LSA for size 8)		
Contact termination	Crimp Solder Cup Solder PCB Press-Fit		
Insulator material	DAP, PBT	PBT	
Insulator color	Green (DAP), Blue (PBT)	Blue	
Polarization	Trapezoidal shape of shell		
Number of layouts	5	6	25
Locking system	Jackscrews		

PLATING OPTIONS

MACH-D Connectors					
SHELL PLATING		CODE	SHELL MATERIAL	ROHS COMPLIANT	PLATING SPECIFICATIONS
Electroless nickel		K	Aluminum	YES	ASTM B733, Type V, SC2, Class 4
Stainless steel, passivated		S	Stainless steel	YES	SAE AMS2700 Type 6 Comparable to MIL-DTL-24308 Code P
Cadmium		U	Aluminum	NO	SAE AMS-QQ-P-416 Type II, Class 2 Comparable to MIL-DTL-24308 Code F
Chemical conversion		T	Aluminum	YES	MIL-DTL-5541, Type II, Class 1A and Class 3

The above plating images are software-generated and may differ from the actual product appearance.

The Advantages of Stainless Steel Shells

D-Sub connector shells are typically made from steel, aluminum, or brass. Although these are strong materials, they are vulnerable to moisture and subsequent corrosion. Plating the shell with a protective coating helps abate corrosion, but plating materials are vulnerable and can also be hazardous to the environment -- especially cadmium. There is an increasing industry appetite for shell material options that can survive extremely harsh conditions and be environmentally green.

To address this need, Positronic offers stainless steel shells as a standard option on a variety of our D-Sub connector products -- including MACH-D. Stainless steel does not easily corrode and it can outperform nearly any plating material option in a salt spray test. It is also resistant to high temperatures and is very mechanically robust. Our expertise in stainless steel connector shells is evidenced by the fact that Positronic is approved to manufacture over 600 part numbers as part of the MIL-DTL-24308 QPL. That's more than any other connector manufacturer in the industry. Give stainless steel the opportunity to prove why it is quickly becoming one of the most desirable D-Sub shell materials available on the market today!

NEW ACCESSORIES & FEATURES

EMI Grounding Strips

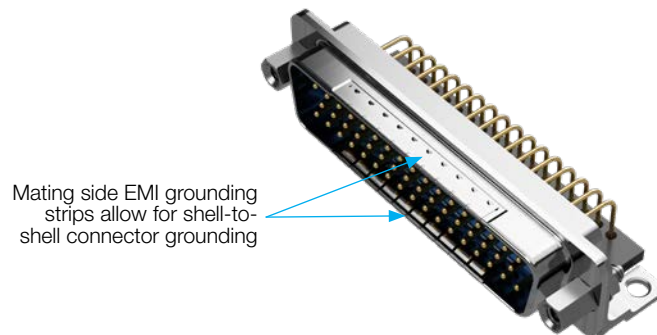

Keyed / Polarized Jackscrew System

This keyed jackscrew system functions by way of corresponding keyways on the Code K rotating male jackscrew and Code S fixed female jackpost. When used properly, this system allows for 36 unique key combinations, which are user-configurable. The rotating male jackscrews feature an internal hex head for trouble-free rotation.

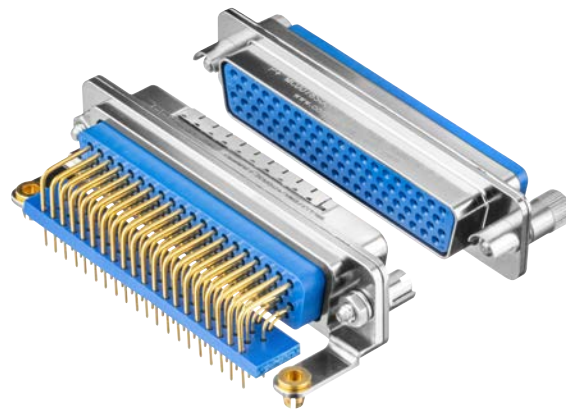

Banding Feature on Rear Connector Shell

For applications requiring both 360 degree braid shield termination as well as desirable strain relief characteristics, the new diamond knurl banding feature is a perfect solution.

This is an option on the rear shell of all MACH-D connectors by selecting Code C in the Backshells & Boardlocks step.

This feature is designed for use with standard banding-style clamps and tooling. The diamond knurl is ideal in preventing braid rotation and slippage.

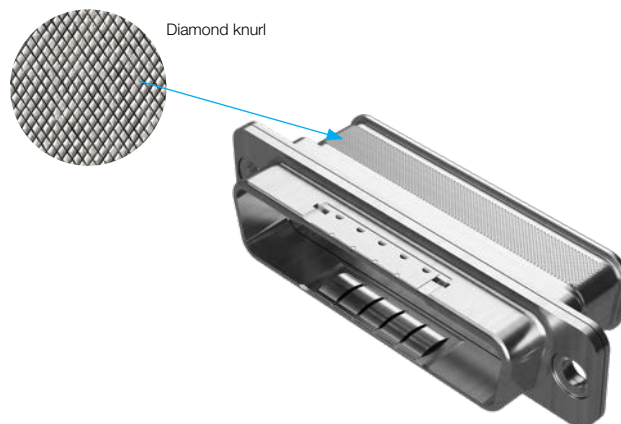

M24308 AT A GLANCE

Overview

The M24308 D-Subminiature connector is a standardized military connector, defined by United States military specification MIL-DTL-24308. Small enough to fit into tight spaces and with proven reliability, M24308 connectors are an ideal choice for mission-critical tasks where connector performance cannot be a question.



About M24308

M24308 connectors come in many different styles with a variety of options for class, contact termination, and type. They are designed to operate between -55°C and +125°C. Compact and spatially efficient, M24308 connectors are ideal for applications requiring high density packaging. You can find these connectors in a variety of applications from communication and information technology to aircraft, missiles, and satellites.

Positronic products meet or exceed the requirements set forth within the M24308 specification. Our connectors have gone through rigorous testing to certify quality and performance. They are built for mission-critical applications – where failure is not an option.

Positronic products are part of the U.S. Defense Logistics Agency (DLA) Qualified Products List (QPL), which means they have met the qualification requirements, including appropriate product identification, qualification, and periodic verification testing. This designation means the products are trusted and approved for use in any appropriate application requiring high quality components.

The MIL-DTL-24308 specification can be downloaded at <https://quicksearch.dla.mil>



Positronic MACH-D Connectors



Although machined shell D-Sub connectors are not included as part of MIL-DTL-24308, MACH-D connectors are fully intermateable with standard M24308-type D-Subs and, in many cases, outperform the minimum requirements as outlined in MIL-DTL-24308. For our DD, HDC, and RD Series connectors, Positronic has held its position on the MIL-DTL-24308 QPL for over 40 years and we continue to boast the largest M24308 QPL of any connector manufacturer. Qualified materials, processes, and supply chain are the backbone of our connectors, which we rely on for every D-Sub product from industrial to military and space-grade product offerings.

LAYOUTS

Connectors shown at actual size. Face view of male or rear view of female shown. All Positronic products utilize solid, machined contacts.

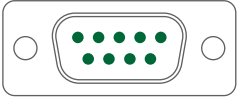
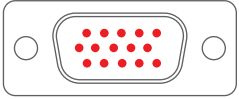
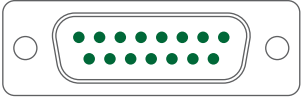
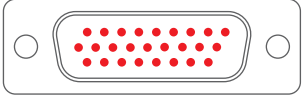
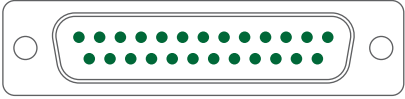
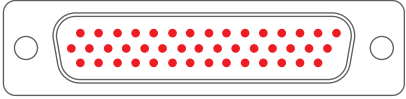
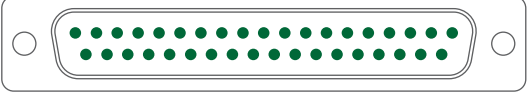
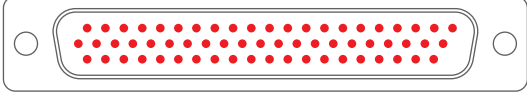
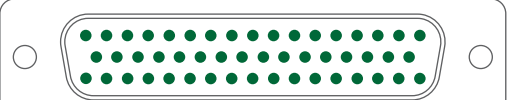
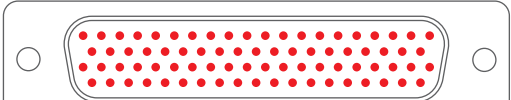
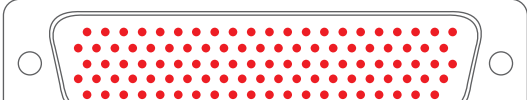
Scale 1:1

MCD STANDARD DENSITY	SIZE	MCDD HIGH DENSITY
 (9) #20	1	 (15) #22
 (15) #20	2	 (26) #22
 (25) #20	3	 (44) #22
 (37) #20	4	 (62) #22
 (50) #20	5	 (78) #22
	6	 (104) #22

CONTACT SIZE	
#20	#22
	

LAYOUTS

Connectors shown at actual size. Face view of male or rear view of female shown. All Positronic products utilize solid, machined contacts

Scale 1:1

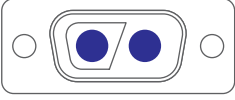
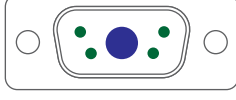
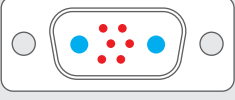
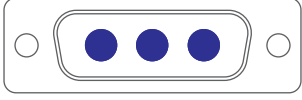
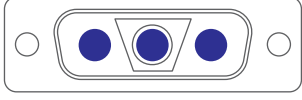
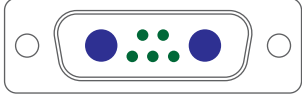
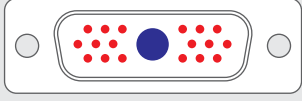
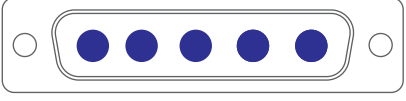
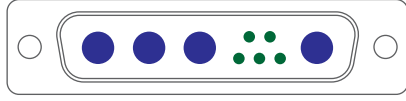
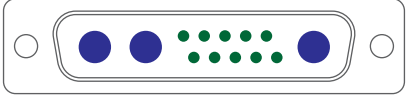
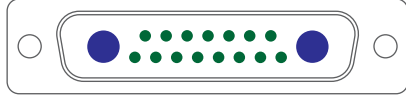
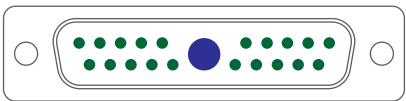
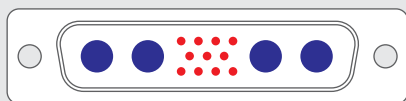

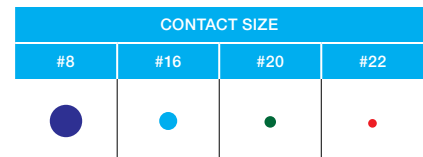
MCBX	SIZE	MCBX
 <p>2WK2 (2) #8</p>	1	 <p>5W1 (1) #8, (4) #20</p>
<p>Contact Technical Sales</p>  <p>8W2 (2) #16, (6) #22</p>		
 <p>3W3 (3) #8</p>	2	 <p>3WK3 (3) #8</p>
 <p>7W2 (2) #8, (5) #20</p>		
<p>Contact Technical Sales</p>  <p>19W1 (1) #8, (18) #22</p>	3	
 <p>5W5 (5) #8</p>		 <p>9W4 (4) #8, (5) #20</p>
 <p>13W3 (3) #8, (10) #20</p>		 <p>17W2 (2) #8, (15) #20</p>
 <p>21W1 (1) #8, (20) #20</p>		<p>Contact Technical Sales</p>  <p>15W4 (4) #8, (11) #22</p>



LAYOUTS

Connectors shown at actual size. Face view of male or rear view of female shown. All Positronic products utilize solid, machined contacts

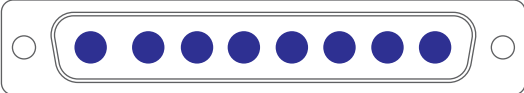
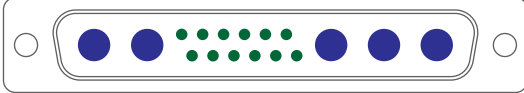
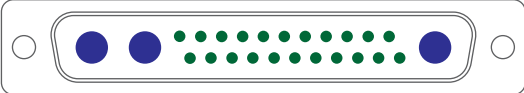
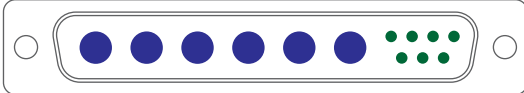
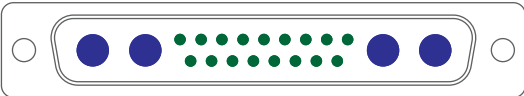
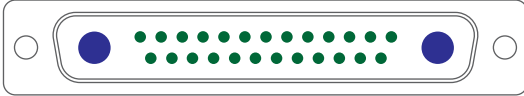
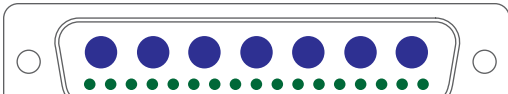
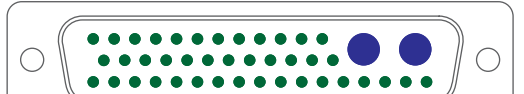
Scale 1:1

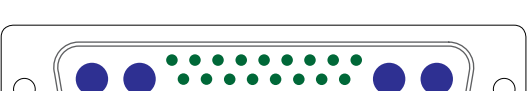
MCBX	SIZE	MCBX
 8W8 (8) #8	4	 17W5 (5) #8, (12) #20
 25W3 (3) #8, (22) #20		 13W6 (6) #8, (7) #20
 21WA4 (4) #8, (17) #20		 27W2 (2) #8, (25) #20
 24W7 (7) #8, (17) #20	5	 43W2 (2) #8, (41) #20
 36W4 (4) #8, (32) #20		 47W1 (1) #8, (46) #20
 46W4 (4) #8, (42) #20	6	

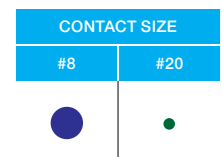

POSIBAND®

PosiBand is a unique contact technology that eliminates the weaknesses of the split-tine design.

- The PosiBand female contact configuration features a higher cross-sectional area of material compared to split-tine designs and a solid, unbroken ring at the entry point, which increases the mechanical robustness of the contact.
- PosiBand has greater surface engagement at the male and female contact interface, resulting in more consistent electrical performance.
- Resistance of size 22 contacts is 5 milliohms, maximum. Resistance of size 20 contacts is 4 milliohms, maximum. Low contact resistance offers opportunities to use size 22 and size 20 contacts for power.
- PosiBand has lower average insertion forces, resulting in greater ease in mating, especially in larger high density connectors. The average lower insertion force is accomplished while meeting or exceeding performance requirements.
- As the PosiBand external pressure element performs the mechanical action of the connection, the contact body material can be selected from a large spectrum of alloys featuring higher conductivity or superior crimp deformation properties, eliminating the need for further processing such as annealing.
- PosiBand is qualified under SAE AS39029 and MIL-DTL-24308 specifications. PosiBand is also qualified to the higher 40 gram contact separation test requirement of GSFC S-311-P4/08 and GSFC S-311-P4/10.

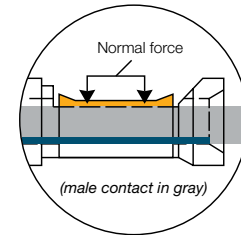

PosiBand®

Over-separation is **eliminated**

Surface engagement is **consistent** along the barrel

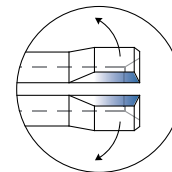

Open Entry

Over-separation is **limited** by insulator cavity

Surface engagement **concentrated** at the tip

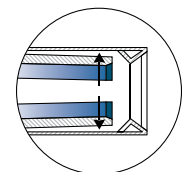

Legacy Closed Entry

Over-separation is **limited** by sleeve

Surface engagement **concentrated** at the tip

TEMPERATURE RISE CURVES

Tested per IEC Publication 60512-3, Test 5a

MCD / MCBX #20 Contacts

Initial Contact Resistance: 4 milliohms, maximum.
 Curve developed using 50-pin Standard Density D-subminiature connectors loaded with size 20 crimp contacts terminated to 20 AWG wire.

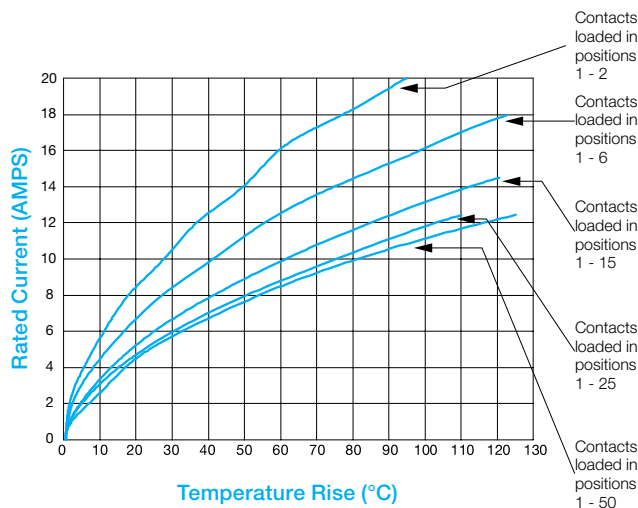

MCDD #22 Contacts

Initial Contact Resistance: 5 milliohms, maximum.
 Curve developed using 104-pin High Density D-subminiature wire connectors loaded with size 22 crimp contacts terminated to 22 AWG wire.

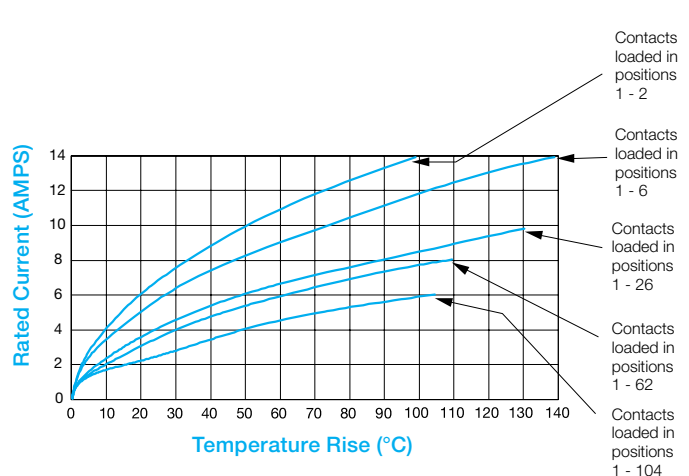

TEMPERATURE RISE CURVES

Tested per IEC Publication 60512-3, Test 5a

MCBX3W3 #8 Contacts

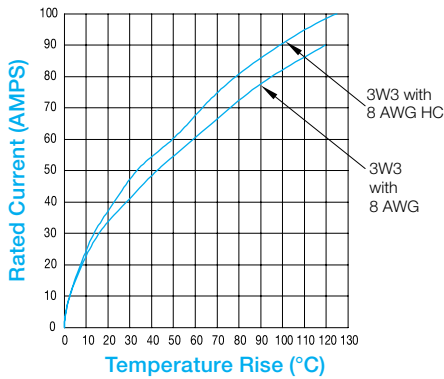

Curves developed using male crimp connectors mated to female crimp connectors.

Higher performing curve is developed using [high conductivity \(HC\)](#) contacts.

MCBX8W8 #8 Contacts

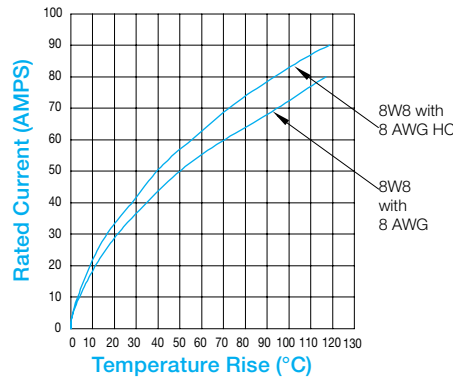

Curves developed using male crimp connectors mated to female crimp connectors.

Higher performing curve is developed using [high conductivity \(HC\)](#) contacts.

MCBX8W8 #8 Contacts

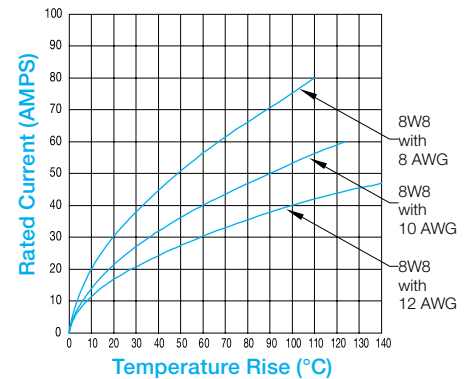

Curves developed using male crimp connectors mated to female crimp connectors.

Curves are developed using [standard conductivity](#) contacts.

MCBX7W2 #8 Contacts

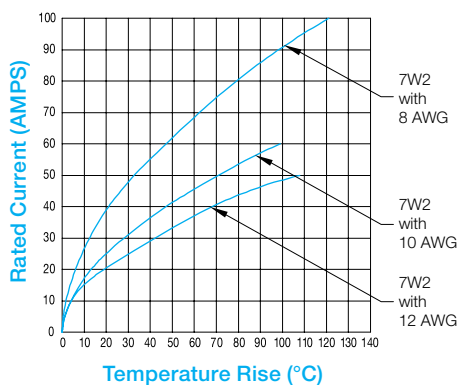

Curves developed using male crimp connectors mated to female PCB terminations.

Curves are developed using [standard conductivity](#) contacts.

MCBX21WA4 #8 Contacts

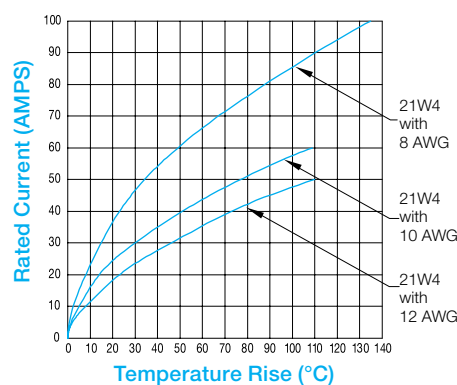

Curves developed using male crimp connectors mated to female PCB terminations.

Curves are developed using [standard conductivity](#) contacts.

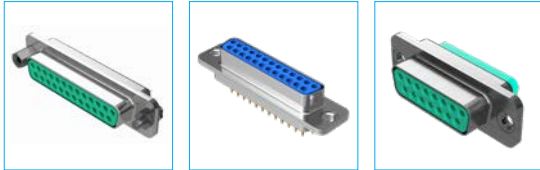

MCD Series connectors are standard density D-Sub connectors, built for high-performance applications requiring rugged machined shells. Features include:

- Machined shells for ruggedness, planarity, and precision
- Interfacial seals and rear grommets for waterproofing
- Unique accessories include EMI grounding strips, keyed jackscrews, and banding backshell
- Quality and performance in accordance with MIL-DTL-24308

Trust the **MCD** to deliver **The Science of Certainty** in mission-critical applications.

TECH SPECS

GENERAL

Part Number Prefix	MCD
Performance Level	Mil/Aero Spaceflight
Conformance	Meets or exceeds performance requirements for MIL-DTL-24308; fully intermateable to MIL-DTL-24308 connectors Meets or exceeds performance requirements for NASA Goddard GSFC-311; fully intermateable to GSFC-311 connectors
RoHS Compliance	Optional

MATERIAL

IN ACCORDANCE WITH

Insulator	PBT (PCB terminations) DAP (wire terminations)	MIL-DTL-24308 §3.3.5.1
Insulator Color	Blue (PBT), Green (DAP)	
Flammability Rating	UL 94V-0	UL 94
Contact Material	Copper alloy	MIL-DTL-24308 §3.3.4; AS39029 MIL-DTL-24308 §3.3.4.2; AS39029
Contact Plating	50 µin gold over nickel or copper underplate	MIL-DTL-24308 §3.3.4.1; AS39029
Shell Material	Aluminum Stainless steel <i>For other shell options, please contact Technical Sales</i>	ASTM B221 ASTM A240
Shell Finish	Electroless nickel Stainless steel, passivated Cadmium Chemical conversion coating	See page 3
Interfacial Seal	Fluorosilicone	MIL-R-25988 Type II Class I Grade 40
Rear Grommet	Fluorosilicone	MIL-R-25988 Type II Class I Grade 40

TECH SPECS

MATERIAL		IN ACCORDANCE WITH
EMI Spring	Copper alloy, plated electroless nickel	ASTM B194; AMS-C-26074
Adhesive/Sealant	MasterBond Supreme 10AOHT 3M DP190 <i>For low outgassing requirements, please contact Technical Sales</i>	
Conductive Gasket	CHOFORM 5513 <i>For non-conductive options or configurations compatible with Spira-Shield metal EMI shielding, please contact Technical Sales</i>	

ELECTRICAL		IN ACCORDANCE WITH
Working Voltage (rms)	300V	EIA-364-20
Initial Contact Resistance	4 mΩ maximum	MIL-DTL-24308 §3.5.9; EIA-364-06; IEC 60512-2, Test 2b
Contact Current Rating at 70°C Temperature Rise	18A 2 contacts energized 14A 6 contacts energized 11A 15 contacts energized 10A 25 contacts energized 9A 50 contacts energized	UL 1977
Insulation Resistance	5 GΩ	MIL-DTL-24308 §3.5.8; EIA-364-21
Proof Voltage (rms)	1000V	EIA-364-20

MECHANICAL		IN ACCORDANCE WITH
Female Contact Design	PosiBand closed entry	
Contact Retention in Insulator	40N [9 lbs] (removable contacts only)	MIL-DTL-24308 §3.5.5; EIA-364-29
Resistance to Soldering Heat		
- Hand Soldering	360°C [680°F] for 4 seconds	MIL-STD-202-210, condition A
- Wave Soldering	260°C [500°F] for 20 seconds	MIL-STD-202-210, condition C
Polarization	Trapezoidal shape of shell	
Mechanical Durability	500 cycles	MIL-DTL-24308 §3.5.16; EIA-364-09
Shock and Vibration	See page 36 for more details	

ENVIRONMENTAL		IN ACCORDANCE WITH
Operating Temperature	-55 to 125°C	MIL-DTL-24308 §3.5.11; EIA-364-32
Outgassing	Low outgassing options (TML <1.0%, CVCM <0.1%, RML <1.0%) are available, <i>please contact Technical Sales.</i>	ASTM E 595; ECSS-Q-ST-70-02C
Waterproof	IP67 (<i>when ordered with the IP-rated panel mount accessories</i>)	IEC 60529

SHELL DIMENSIONS

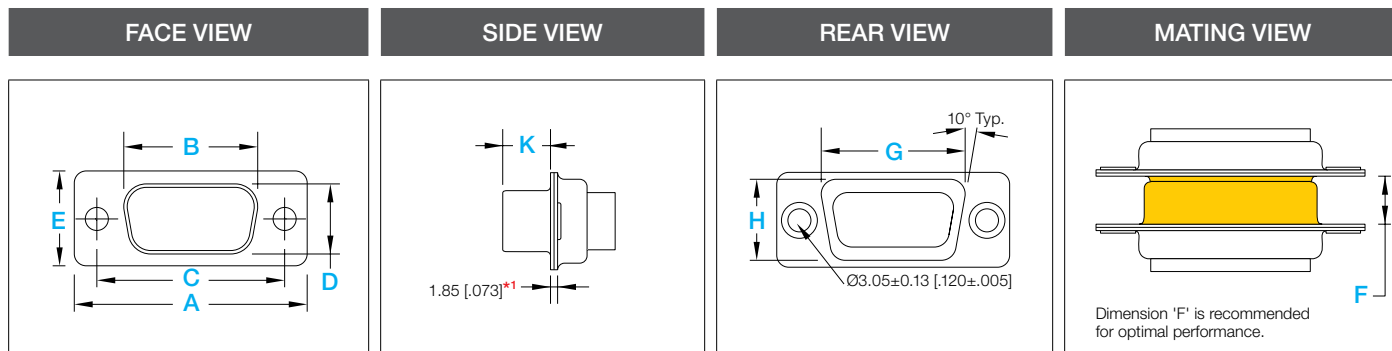

*1 The 1.85 [.073] shell thickness in the SIDE VIEW is only valid for configurations without angle brackets.

SHELL SIZE	GENDER	A ±0.38 [.015]	B ±0.13 [.005]	C ±0.13 [.005]	D ±0.13 [.005]	E ±0.38 [.015]	G ±0.25 [.010]	H ±0.25 [.010]	K ±0.13 [.005]	F ±0.38 [.015]
1	Male	30.81 [1.213]	18.75 [.738]	24.99 [.984]	10.19 [.401]	12.55 [.494]	19.82 [.780]	10.82 [.426]	5.92 [.233]	6.73 [.265]
	Female		16.33 [.643]		7.90 [.311]				6.17 [.243]	
2	Male	39.14 [1.541]	27.08 [1.066]	33.32 [1.312]	10.19 [.401]	12.55 [.494]	28.15 [1.108]	10.82 [.426]	5.92 [.233]	6.73 [.265]
	Female		24.66 [.971]		7.90 [.311]				6.17 [.243]	
3	Male	53.04 [2.088]	40.79 [1.606]	47.04 [1.852]	10.19 [.401]	12.55 [.494]	41.87 [1.648]	10.82 [.426]	5.84 [.230]	6.50 [.256]
	Female		38.19 [1.504]		7.90 [.311]				6.17 [.243]	
4	Male	69.32 [2.729]	57.25 [2.254]	63.50 [2.500]	10.19 [.401]	12.55 [.494]	58.28 [2.294]	10.82 [.426]	5.84 [.230]	6.50 [.256]
	Female		54.84 [2.159]		7.90 [.311]				6.17 [.243]	
5	Male	66.93 [2.635]	54.64 [2.151]	61.11 [2.406]	13.03 [.513]	15.37 [.605]	55.88 [2.200]	13.67 [.538]	5.84 [.230]	6.50 [.256]
	Female		52.43 [2.064]		10.74 [.423]				6.17 [.243]	

CONTACT TERMINATIONS

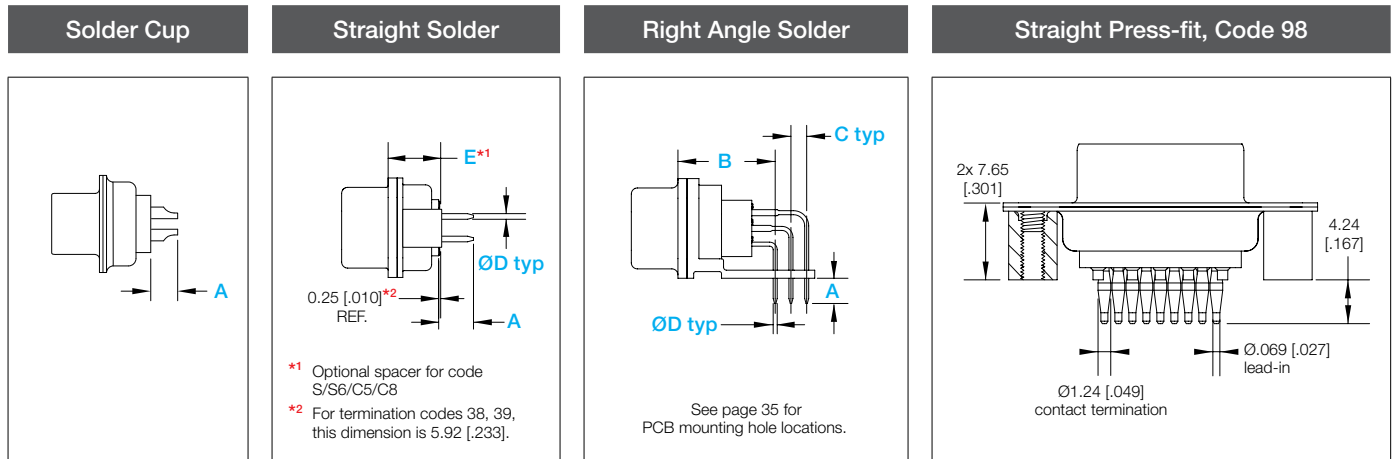

Code	Termination type	A	B	C	ØD	E
0/1	Crimp	--	--	--	--	6.60 [.260]
2	Solder cup	3.18 [.125]	--	--	--	11.37 [.448]
3	Straight solder	4.31 [.170]	--	--	0.76 [.030]	6.60 [.260]
31	Straight solder	4.31 [.170]	--	--	1.01 [.040]	6.60 [.260]
32	Straight solder	9.52 [.375]	--	--	0.76 [.030]	6.60 [.260]
33	Straight solder	12.70 [.500]	--	--	0.76 [.030]	6.60 [.260]
36	Straight solder	6.00 [.236]	--	--	0.60 [.024]	6.60 [.260]
38	Straight solder	8.45 [.333]	--	--	0.76 [.030]	12.29 [.484]
39	Straight solder	11.63 [.458]	--	--	0.76 [.030]	12.29 [.484]
4	Right angle solder	4.31 [.170]	12.34 [.486]	2.84 [.112]	0.76 [.030]	--
42	Right angle solder	5.00 [.197]	10.3 [.406]	2.54 [.100]	0.60 [.024]	--
5	Right angle solder	4.31 [.170]	8.07 [.318]	2.84 [.112]	0.76 [.030]	--
51	Right angle solder	3.18 [.125]	8.07 [.318]	2.84 [.112]	0.76 [.030]	--
52	Right angle solder	6.35 [.250]	8.07 [.318]	2.84 [.112]	0.76 [.030]	--
53	Right angle solder	4.31 [.170]	8.07 [.318]	2.84 [.112]	1.01 [.040]	--
54	Right angle solder	3.18 [.125]	8.07 [.318]	2.84 [.112]	1.01 [.040]	--

CREATE A PART

For additional options and accessories, please see following page.

MCD	37	S	5	R2	N	0	S	/AA	-15	
------------	-----------	----------	----------	-----------	----------	----------	----------	------------	------------	--

Series	MCD Standard Density	Modifications	-XXXX See bottom of following page for typical modification options																																
Layout	<table border="0"> <tr> <td>9</td> <td>(9) #20</td> <td>37</td> <td>(37) #20</td> </tr> <tr> <td>15</td> <td>(15) #20</td> <td>50</td> <td>(50) #20</td> </tr> <tr> <td>25</td> <td>(25) #20</td> <td></td> <td></td> </tr> </table>	9	(9) #20	37	(37) #20	15	(15) #20	50	(50) #20	25	(25) #20			Contact Plating	<table border="0"> <tr> <td>-15</td> <td>50µin Au (min) over Ni over Cu</td> </tr> <tr> <td>-50</td> <td>50µin Au (min) over Cu</td> </tr> </table>	-15	50µin Au (min) over Ni over Cu	-50	50µin Au (min) over Cu																
9	(9) #20	37	(37) #20																																
15	(15) #20	50	(50) #20																																
25	(25) #20																																		
-15	50µin Au (min) over Ni over Cu																																		
-50	50µin Au (min) over Cu																																		
Contact Gender	<table border="0"> <tr> <td>M</td> <td>Male pin</td> </tr> <tr> <td>NEW MG</td> <td>Male pin with grounding strips</td> </tr> <tr> <td>P</td> <td>Male pin with interfacial seal</td> </tr> <tr> <td>NEW PG</td> <td>Male pin with interfacial seal & grounding strips</td> </tr> <tr> <td>S</td> <td>Female socket</td> </tr> </table>	M	Male pin	NEW MG	Male pin with grounding strips	P	Male pin with interfacial seal	NEW PG	Male pin with interfacial seal & grounding strips	S	Female socket	Environmental Compliance	/AA RoHS																						
M	Male pin																																		
NEW MG	Male pin with grounding strips																																		
P	Male pin with interfacial seal																																		
NEW PG	Male pin with interfacial seal & grounding strips																																		
S	Female socket																																		
Termination	<table border="0"> <tr> <td>0</td> <td>Wire, order contacts separately</td> </tr> <tr> <td>1</td> <td>Wire, crimp contacts included, 20 - 24 AWG [0.50mm² - 0.25mm²]</td> </tr> <tr> <td>19</td> <td>Wire, M39029 crimp contacts included, 20 - 24 AWG [0.50mm² - 0.25mm²].</td> </tr> <tr> <td>2</td> <td>Wire, fixed solder cup, 0.5mm² [20 AWG] max.</td> </tr> <tr> <td>3</td> <td>Straight solder, 0.71 [.030] tail diameter, 4.32 [.170] tail length</td> </tr> <tr> <td>32</td> <td>Straight solder, 0.71 [.030] tail diameter, 9.52 [.375] tail length</td> </tr> <tr> <td>4</td> <td>Right angle solder, 0.71 [.030] tail diameter, 12.34 [.486] contact extension, 4.32 [.170] tail length</td> </tr> <tr> <td>5</td> <td>Right angle solder, 0.71 [.030] tail diameter, 8.07 [.318] contact extension, 4.32 [.170] tail length</td> </tr> <tr> <td>98</td> <td>Straight press-fit</td> </tr> </table>	0	Wire, order contacts separately	1	Wire, crimp contacts included, 20 - 24 AWG [0.50mm ² - 0.25mm ²]	19	Wire, M39029 crimp contacts included, 20 - 24 AWG [0.50mm ² - 0.25mm ²].	2	Wire, fixed solder cup, 0.5mm ² [20 AWG] max.	3	Straight solder, 0.71 [.030] tail diameter, 4.32 [.170] tail length	32	Straight solder, 0.71 [.030] tail diameter, 9.52 [.375] tail length	4	Right angle solder, 0.71 [.030] tail diameter, 12.34 [.486] contact extension, 4.32 [.170] tail length	5	Right angle solder, 0.71 [.030] tail diameter, 8.07 [.318] contact extension, 4.32 [.170] tail length	98	Straight press-fit	Shells	<table border="0"> <tr> <td>K</td> <td>Aluminum, electroless nickel finish</td> </tr> <tr> <td>S</td> <td>Stainless steel, passivated</td> </tr> </table>	K	Aluminum, electroless nickel finish	S	Stainless steel, passivated										
0	Wire, order contacts separately																																		
1	Wire, crimp contacts included, 20 - 24 AWG [0.50mm ² - 0.25mm ²]																																		
19	Wire, M39029 crimp contacts included, 20 - 24 AWG [0.50mm ² - 0.25mm ²].																																		
2	Wire, fixed solder cup, 0.5mm ² [20 AWG] max.																																		
3	Straight solder, 0.71 [.030] tail diameter, 4.32 [.170] tail length																																		
32	Straight solder, 0.71 [.030] tail diameter, 9.52 [.375] tail length																																		
4	Right angle solder, 0.71 [.030] tail diameter, 12.34 [.486] contact extension, 4.32 [.170] tail length																																		
5	Right angle solder, 0.71 [.030] tail diameter, 8.07 [.318] contact extension, 4.32 [.170] tail length																																		
98	Straight press-fit																																		
K	Aluminum, electroless nickel finish																																		
S	Stainless steel, passivated																																		
Mounting Options	<table border="0"> <tr> <td>0</td> <td>Clearance hole, 3.05 [.120] Ø</td> </tr> <tr> <td>C7</td> <td>IP67-rated inside wall mount, integrated angle brackets with boardlocks, alignment bar, for use with right angle PCB termination types</td> </tr> <tr> <td>C8</td> <td>IP67-rated inside wall mount, standoffs with boardlocks, for use with straight PCB termination types</td> </tr> <tr> <td>G</td> <td>Rear grommet, for use with crimp connectors only</td> </tr> <tr> <td>R2</td> <td>Angle brackets integrated with shell, alignment bar with non-removable female jackposts</td> </tr> <tr> <td>R6</td> <td>Angle brackets integrated with shell, clearance hole, 3.05 [.120] Ø, alignment bar</td> </tr> <tr> <td>R7</td> <td>Angle brackets integrated with shell, 4-40 threaded hole, alignment bar</td> </tr> <tr> <td>R8</td> <td>Angle brackets integrated with shell, 4-40 locknut, alignment bar</td> </tr> <tr> <td>S*1</td> <td>Standoffs, swaged, 4-40</td> </tr> <tr> <td>S5</td> <td>Locknut, swaged, 4-40</td> </tr> <tr> <td>S6</td> <td>Standoffs, swaged, 4-40, boardlocks</td> </tr> </table>	0	Clearance hole, 3.05 [.120] Ø	C7	IP67-rated inside wall mount, integrated angle brackets with boardlocks, alignment bar, for use with right angle PCB termination types	C8	IP67-rated inside wall mount, standoffs with boardlocks, for use with straight PCB termination types	G	Rear grommet, for use with crimp connectors only	R2	Angle brackets integrated with shell, alignment bar with non-removable female jackposts	R6	Angle brackets integrated with shell, clearance hole, 3.05 [.120] Ø, alignment bar	R7	Angle brackets integrated with shell, 4-40 threaded hole, alignment bar	R8	Angle brackets integrated with shell, 4-40 locknut, alignment bar	S*1	Standoffs, swaged, 4-40	S5	Locknut, swaged, 4-40	S6	Standoffs, swaged, 4-40, boardlocks	Locking Systems	<table border="0"> <tr> <td>0</td> <td>None</td> </tr> <tr> <td>E5</td> <td>Rotating male jackscrews, internal hex</td> </tr> <tr> <td>NEW K</td> <td>Rotating male jackscrews, low-profile, internal hex, 36-position polarization (mates to S jackpost)</td> </tr> <tr> <td>NEW S</td> <td>Fixed female jackposts, 36-position polarization (mates to K jackscrew)</td> </tr> <tr> <td>T2</td> <td>Fixed female jackposts, washer set</td> </tr> </table> <p><i>All locking system options are compatible with EN and EJ backshells</i></p>	0	None	E5	Rotating male jackscrews, internal hex	NEW K	Rotating male jackscrews, low-profile, internal hex, 36-position polarization (mates to S jackpost)	NEW S	Fixed female jackposts, 36-position polarization (mates to K jackscrew)	T2	Fixed female jackposts, washer set
0	Clearance hole, 3.05 [.120] Ø																																		
C7	IP67-rated inside wall mount, integrated angle brackets with boardlocks, alignment bar, for use with right angle PCB termination types																																		
C8	IP67-rated inside wall mount, standoffs with boardlocks, for use with straight PCB termination types																																		
G	Rear grommet, for use with crimp connectors only																																		
R2	Angle brackets integrated with shell, alignment bar with non-removable female jackposts																																		
R6	Angle brackets integrated with shell, clearance hole, 3.05 [.120] Ø, alignment bar																																		
R7	Angle brackets integrated with shell, 4-40 threaded hole, alignment bar																																		
R8	Angle brackets integrated with shell, 4-40 locknut, alignment bar																																		
S*1	Standoffs, swaged, 4-40																																		
S5	Locknut, swaged, 4-40																																		
S6	Standoffs, swaged, 4-40, boardlocks																																		
0	None																																		
E5	Rotating male jackscrews, internal hex																																		
NEW K	Rotating male jackscrews, low-profile, internal hex, 36-position polarization (mates to S jackpost)																																		
NEW S	Fixed female jackposts, 36-position polarization (mates to K jackscrew)																																		
T2	Fixed female jackposts, washer set																																		
		Backshells and Boardlocks	<table border="0"> <tr> <td>0</td> <td>None</td> </tr> <tr> <td>NEW C*2</td> <td>Banding feature on rear shell, diamond knurl (eliminates the need for backshell)</td> </tr> <tr> <td>EN</td> <td>Backshell, aluminum, top opening, machined, electroless nickel finish, grounding clips</td> </tr> <tr> <td>P</td> <td>IP67-rated inside wall mount flange, O-ring, for use with C options in Mounting Options step</td> </tr> <tr> <td>N</td> <td>Boardlocks, for use with R angle brackets in Mounting Options step</td> </tr> </table>	0	None	NEW C*2	Banding feature on rear shell, diamond knurl (eliminates the need for backshell)	EN	Backshell, aluminum, top opening, machined, electroless nickel finish, grounding clips	P	IP67-rated inside wall mount flange, O-ring, for use with C options in Mounting Options step	N	Boardlocks, for use with R angle brackets in Mounting Options step																						
0	None																																		
NEW C*2	Banding feature on rear shell, diamond knurl (eliminates the need for backshell)																																		
EN	Backshell, aluminum, top opening, machined, electroless nickel finish, grounding clips																																		
P	IP67-rated inside wall mount flange, O-ring, for use with C options in Mounting Options step																																		
N	Boardlocks, for use with R angle brackets in Mounting Options step																																		

For additional options and accessories, please see following page.

*1 Required if Termination Code 98 selected

*2 Only available for use with Code 0, 1, 12 and 19 in Termination step

ADDITIONAL OPTIONS

Options shown on this page are less common than others. Customers may experience a price and/or lead time impact when selecting these options.

Additional Termination Options

12	Wire, crimp contacts included, 26 - 30 AWG [0.12mm ² - 0.05mm ²]
31	Straight solder, 1.02 [.040] tail diameter, 4.32 [.170] tail length
33	Straight solder, 0.71 [.030] tail diameter, 12.70 [.500] tail length
36	Straight solder, metric footprint, 0.60 [.024] tail diameter, 6.00 [.236] tail length
38	Straight solder, 0.71 [.030] tail diameter, 8.45 [.333] tail length
39	Straight solder, 0.71 [.030] tail diameter, 11.63 [.458] tail length
42	Right angle solder, metric footprint, 0.61 [.024] tail diameter, 10.31 [.406] contact extension, 5.00 [.197] tail length
51	Right angle solder, 0.71 [.030] tail diameter, 8.07 [.318] contact extension, 3.18 [.125] tail length
52	Right angle solder, 0.71 [.030] tail diameter, 8.07 [.318] contact extension, 6.35 [.250] tail length
53	Right angle solder, 1.02 [.040] tail diameter, 8.07 [.318] contact extension, 4.32 [.170] tail length
54	Right angle solder, 1.02 [.040] tail diameter, 8.07 [.318] contact extension, 3.18 [.125] tail length

Additional Mounting Options

C5	IP67-rated inside wall mount, standoffs, for use with termination codes 2, 3, and 98
C6	IP67-rated inside wall mount, integrated angle brackets, alignment bar, for use with right angle PCB termination types

Additional Backshell Options

EJ	Backshell, aluminum, top opening, machined, chemical conversion coating, grounding clips
-----------	--

Additional Locking Systems Options

T	Fixed female jackposts, compatible with EN and EJ backshells
----------	--

Additional Shells Options

T	Aluminum, chemical conversion coating
U	Aluminum, cadmium finish - omit Code /AA from Environmental Compliance step when selecting this option

Typical Modification Options

- Low outgassing per ASTM E595 and ECSS-Q-ST-70-02C
- Solder coated contact tails
- Thermocouple contacts
- Blind mate hardware
- Protective dust caps
- EMI dust caps
- ESD packaging
- 100% inspection or other increased inspection levels

Please contact Technical Sales for additional modification options not listed here and for part numbering details.

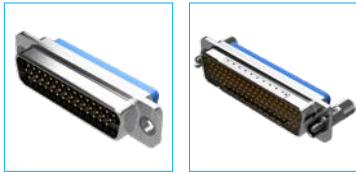

MCDD Series connectors are high density D-sub connectors, built for high performance applications requiring rugged machined shells. Features include:

- Machined shells for ruggedness, planarity, and precision
- Interfacial seals and rear grommets for waterproofing
- Unique accessories include EMI grounding strips, keyed jackscrews, and banding backshell
- Quality and performance in accordance with MIL-DTL-24308

Trust the **MCDD** to deliver ***The Science of Certainty*** in mission-critical applications.

TECH SPECS

GENERAL

Part Number Prefix	MCDD
Performance Level	Mil/Aero Spaceflight
Qualifications	Meets or exceeds performance requirements for MIL-DTL-24308; fully intermateable to MIL-DTL-24308 connectors Meets or exceeds performance requirements for NASA Goddard GSFC-311; fully intermateable to GSFC-311 connectors
RoHS Compliance	Optional

MATERIAL

IN ACCORDANCE WITH

Insulator	PBT	MIL-DTL-24308 §3.3.5.1
Insulator Color	Blue (PBT)	
Flammability Rating	UL 94V-0	UL 94
Contact Material	Copper alloy	MIL-DTL-24308 §3.3.4; AS39029 MIL-DTL-24308 §3.3.4.2; AS39029
Contact Plating	50 µin gold over nickel or copper underplate	MIL-DTL-24308 §3.3.4.1; AS39029
Shell Material	Aluminum Stainless steel <i>For other shell options, please contact Technical Sales</i>	ASTM B221 ASTM A240
Shell Finish	Electroless nickel Stainless steel, passivated Cadmium Chemical conversion coating	See page 3
Interfacial Seal	Fluorosilicone	MIL-R-25988 Type II Class I Grade 40
Rear Grommet	Fluorosilicone	MIL-R-25988 Type II Class I Grade 40

TECH SPECS

MATERIAL		IN ACCORDANCE WITH
EMI Spring	Copper alloy, plated with electroless nickel	ASTM B194; AMS-C-26074
Adhesive/Sealant	MasterBond Supreme 10AOHT 3M DP190 <i>For low outgassing requirements, please contact Technical Sales</i>	
Conductive Gasket	CHOFORM 5513 <i>For non-conductive options or configurations compatible with Spira-Shield metal EMI shielding, please contact Technical Sales</i>	

ELECTRICAL		IN ACCORDANCE WITH
Working Voltage (rms)	300V	EIA-364-20
Initial Contact Resistance	5 mΩ maximum	MIL-DTL-24308 §3.5.9; EIA-364-06; IEC 60512-2, Test 2b
Contact Current Rating at 70°C Temperature Rise	12A 2 contacts energized 10A 6 contacts energized 7.5A 26 contacts energized 6.5A 62 contacts energized 5.0A 104 contacts energized	UL 1977
Insulation Resistance	5 GΩ	MIL-DTL-24308 §3.5.8; EIA-364-21
Proof Voltage	1000V	EIA-364-20

MECHANICAL		IN ACCORDANCE WITH
Female Contact Design	PosiBand closed entry	
Contact Retention In Insulator	40N [9 lbs] (removable contacts only)	MIL-DTL-24308 §3.5.5; EIA-364-29
Resistance To Soldering Heat - Selective Soldering - Wave Soldering	360°C [680°F] for 4 seconds 260°C [500°F] for 20 seconds	MIL-STD-202-210, condition A MIL-STD-202-210, condition C
Polarization	Trapezoidal shape of shell	
Mechanical Durability	500 cycles	MIL-DTL-24308 §3.5.16; EIA-364-09
Shock and Vibration	See page 36 for more details	

ENVIRONMENTAL		IN ACCORDANCE WITH
Operating Temperature	-55 to 125°C	MIL-DTL-24308 §3.5.11; EIA-364-32
Outgassing	Low outgassing options (TML <1.0%, CVCM <0.1%, RML <1.0%) are available, <i>please contact Technical Sales.</i>	ASTM E 595; ECSS-Q-ST-70-02C
Waterproof	IP67 (<i>when ordered with the IP-rated panel mount accessories</i>)	IEC 60529

SHELL DIMENSIONS

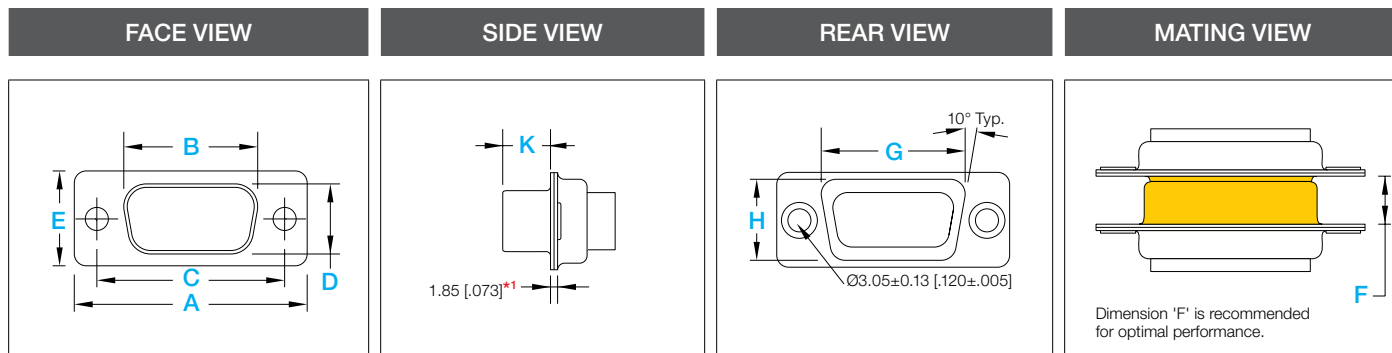

*1 The 1.85 [0.073] shell thickness in the SIDE VIEW is only valid for configurations without angle brackets.

SHELL SIZE	GENDER	A ±0.38 [.015]	B ±0.13 [.005]	C ±0.13 [.005]	D ±0.13 [.005]	E ±0.38 [.015]	G ±0.25 [.010]	H ±0.25 [.010]	K ±0.13 [.005]	F ±0.38 [.015]
1	Male	30.81 [1.213]	18.75 [.738]	24.99 [.984]	10.19 [.401]	12.55 [.494]	19.82 [.780]	10.82 [.426]	5.92 [.233]	6.73 [.265]
	Female		16.33 [.643]		7.90 [.311]				6.17 [.243]	
2	Male	39.14 [1.541]	27.08 [1.066]	33.32 [1.312]	10.19 [.401]	12.55 [.494]	28.15 [1.108]	10.82 [.426]	5.92 [.233]	6.73 [.265]
	Female		24.66 [.971]		7.90 [.311]				6.17 [.243]	
3	Male	53.04 [2.088]	40.79 [1.606]	47.04 [1.852]	10.19 [.401]	12.55 [.494]	41.87 [1.648]	10.82 [.426]	5.84 [.230]	6.50 [.256]
	Female		38.19 [1.504]		7.90 [.311]				6.17 [.243]	
4	Male	69.32 [2.729]	57.25 [2.254]	63.50 [2.500]	10.19 [.401]	12.55 [.494]	58.28 [2.294]	10.82 [.426]	5.84 [.230]	6.50 [.256]
	Female		54.84 [2.159]		7.90 [.311]				6.17 [.243]	
5	Male	66.93 [2.635]	54.64 [2.151]	61.11 [2.406]	13.03 [.513]	15.37 [.605]	55.88 [2.200]	13.67 [.538]	5.84 [.230]	6.50 [.256]
	Female		52.43 [2.064]		10.74 [.423]				6.17 [.243]	
6	Male	69.32 [2.729]	58.01 [2.284]	63.50 [2.500]	14.61 [.575]	16.97 [.668]	59.03 [2.324]	15.24 [.600]	5.84 [.230]	6.50 [.256]
	Female		55.60 [2.189]		12.32 [.485]				6.17 [.243]	

CONTACT TERMINATIONS

Straight Solder

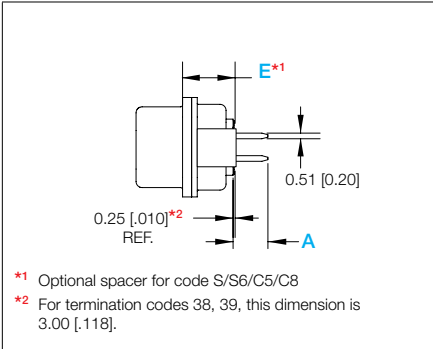

Right Angle Solder

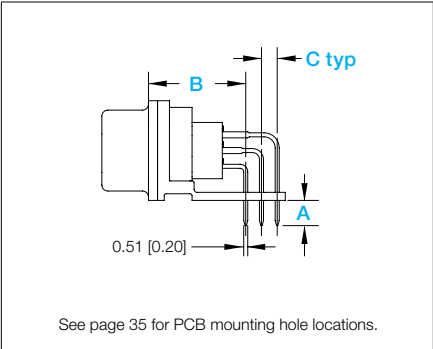

Straight Press-fit, Code 98

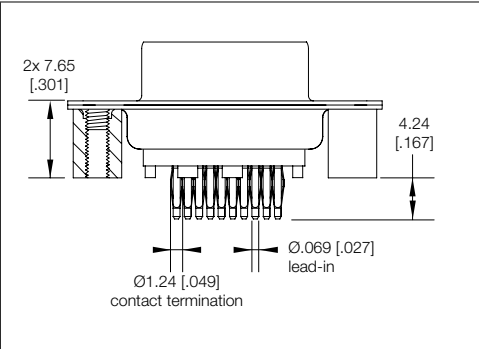

Code	Termination type	A	B	C	E
0/1	Crimp	--	--	--	10.41 [.410]
3	Straight solder	3.81 [.150]	--	--	10.41 [.410]
32	Straight solder	7.62 [.300]	--	--	10.41 [.410]
33	Straight solder	12.70 [.500]	--	--	10.41 [.410]
38	Straight solder	5.53 [.218]	--	--	12.29 [.484]
39	Straight solder	8.71 [.343]	--	--	12.29 [.484]
4 (Shell sizes 1-4)	Right angle solder	3.18 [.125]	12.34 [.486]	1.98 [.078]	--
4 (Shell sizes 5-6)	Right angle solder	3.18 [.125]	12.34 [.486]	2.08 [.082]	--
51 (Shell sizes 1-4)	Right angle solder	3.18 [.125]	8.07 [.318]	1.98 [.078]	--
51 (Shell sizes 5-6)	Right angle solder	3.18 [.125]	8.07 [.318]	2.08 [.082]	--
52 (Shell sizes 1-4)	Right angle solder	6.35 [.250]	8.07 [.318]	1.98 [.078]	--
52 (Shell sizes 5-6)	Right angle solder	6.35 [.250]	8.07 [.318]	2.08 [.082]	--

CREATE A PART

For additional options and accessories, please see following page.

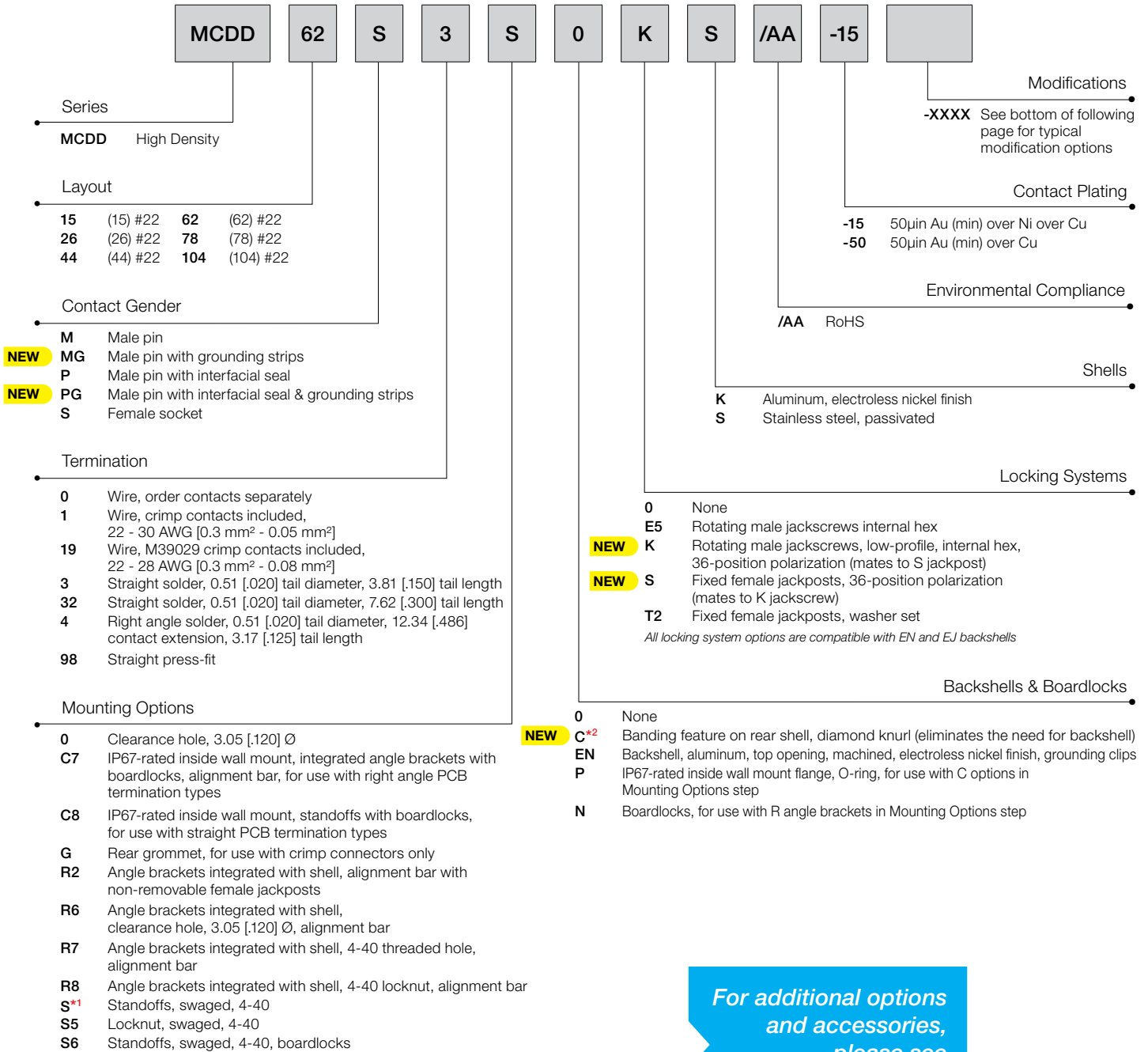

For additional options and accessories, please see following page.

*1 Required if Termination Code 98 selected

*2 Only available for use with Code 0, 1 and 19 in Termination step

ADDITIONAL OPTIONS

Options shown on this page are less common than others. Customers may experience a price and/or lead time impact when selecting these options.

Additional Termination Options

2	Wire, removable solder cup, 22 - 30 AWG [0.3mm ² -0.05mm ²]
33	Straight solder, 0.51 [.020] tail diameter, 12.70 [.500] tail length
38	Straight solder, 0.51 [.020] tail diameter, 5.53 [.218] tail length
39	Straight solder, 0.51 [.020] tail diameter, 8.71 [.343] tail length
51	Right angle solder, 0.51 [.020] tail diameter, 8.07 [.318] contact extension, 3.18 [.125] tail length
52	Right angle solder, 0.51 [.020] tail diameter, 8.07 [.318] contact extension, 6.35 [.250] tail length

Additional Mounting Options

C5	IP67-rated inside wall mount, standoffs, for use with termination codes 2, 3, and 98
C6	IP67-rated inside wall mount, integrated angle brackets, alignment bar, for use with right angle PCB termination types

Additional Backshell Options

EJ	Backshell, aluminum, top opening, machined, chemical conversion coating, grounding clips
-----------	--

Additional Locking Systems Options

T	Fixed female jackposts, compatible with EN and EJ backshells
----------	--

Additional Shells Options

T	Aluminum, chemical conversion coating
U	Aluminum, cadmium finish - omit Code /AA from Environmental Compliance step when selecting this option

Typical Modification Options

- Low outgassing per ASTM E595 and ECSS-Q-ST-70-02C
- Solder coated contact tails
- Thermocouple contacts
- Blind mate hardware
- Protective dust caps
- EMI dust caps
- ESD packaging
- 100% inspection or other increased inspection levels

Please contact Technical Sales for additional modification options not listed here and for part numbering details.



MCBX Series connectors are mixed density, combination D-Sub connectors built for high-performance applications requiring rugged machined shells. Features include:

- Ability to mix power and signal together in one D-Sub package
- Twenty-five (25) layout options available
- Machined shells for ruggedness, planarity, and precision
- Unique accessories include EMI grounding strips, keyed jackscrews, and banding backshell
- Quality and performance in accordance with MIL-DTL-24308

Trust the **MCBX** to deliver *The Science of Certainty* in mission-critical applications.

TECH SPECS

GENERAL

Part Number Prefix	MCBX
Performance Level	Mil/Aero Spaceflight
Qualifications	Meets or exceeds performance requirements for MIL-DTL-24308 Meets or exceeds performance requirements for NASA Goddard GSFC-311
RoHS Compliance	Optional

MATERIAL

IN ACCORDANCE WITH

Insulator	PBT	MIL-DTL-24308 §3.3.5.1
Insulator Color	Blue (PBT)	
Flammability Rating	UL 94V-0	UL 94
Contact Material	Copper alloy	MIL-DTL-24308 §3.3.4; AS39029 MIL-DTL-24308 §3.3.4.2; AS39029
Signal Contact Plating	50 µin gold over nickel or copper underplate	MIL-DTL-24308 §3.3.4.1; AS39029 MIL-DTL-24308 §3.3.4.2; AS39029
Power Contact Plating	50 µin gold over nickel or copper underplate	MIL-DTL-24308 §3.3.4.1
Shell Material	Aluminum Stainless steel <i>For other shell options, please contact Technical Sales</i>	ASTM B221 ASTM A240
Shell Finish	Electroless nickel Stainless steel, passivated Cadmium Chemical conversion coating	See page 3
Interfacial Seal	<i>Contact Technical Sales</i>	
Rear Grommet	<i>Contact Technical Sales</i>	

TECH SPECS

MATERIAL		IN ACCORDANCE WITH
EMI Spring	Copper alloy, plated with electroless nickel	ASTM B194; AMS-C-26074
Adhesive/Sealant	RTV 133 MasterBond Supreme 10AOHT 3M DP190 <i>For low outgassing requirements, please contact Technical Sales</i>	
Conductive Gasket	CHOFORM 5513 <i>For non-conductive options or configurations compatible with Spira-Shield metal EMI shielding, please contact Technical Sales</i>	
ELECTRICAL		IN ACCORDANCE WITH
Working Voltage (rms)	300V	EIA-364-20
Initial Contact Resistance	Size 8 0.5 mΩ maximum Size 16 1 mΩ maximum Size 20 4 mΩ maximum Size 22 5 mΩ maximum	MIL-DTL-24308 §3.5.9; EIA-364-06; IEC 60512-2, Test 2b
Contact Current Rating at 70°C Temperature Rise	Up to 75A, see page 10	UL 1977
Insulation Resistance	5 GΩ	MIL-DTL-24308 §3.5.8; EIA-364-21
Proof Voltage	1000V	EIA-364-20
MECHANICAL		IN ACCORDANCE WITH
Female Contact Design	PosiBand Closed Entry (LSA for size 8)	
Contact Retention In Insulator	40N [9 lbs] (Applies to removable signal contacts) 98N [22 lbs] (Applies to size 8 contacts)	MIL-DTL-24308 §3.5.5; EIA-364-29
Resistance To Soldering Heat - Selective Soldering - Wave Soldering	360°C [680°F] for 4 seconds 260°C [500°F] for 20 seconds	MIL-STD-202-210, condition A MIL-STD-202-210, condition C
Polarization	Trapezoidal shape of shell	
Mechanical Durability	500 cycles	MIL-DTL-24308 §3.5.16; EIA-364-09
ENVIRONMENTAL		IN ACCORDANCE WITH
Operating Temperature	-55 to 125°C	MIL-DTL-24308 §3.5.11; EIA-364-32
Outgassing	Low outgassing options (TML <1.0%, CVCM <0.1%, RML <1.0%) are available, please contact Technical Sales.	ASTM E 595; ECSS-Q-ST-70-02C
Waterproof	<i>Contact Technical Sales</i>	

SHELL DIMENSIONS

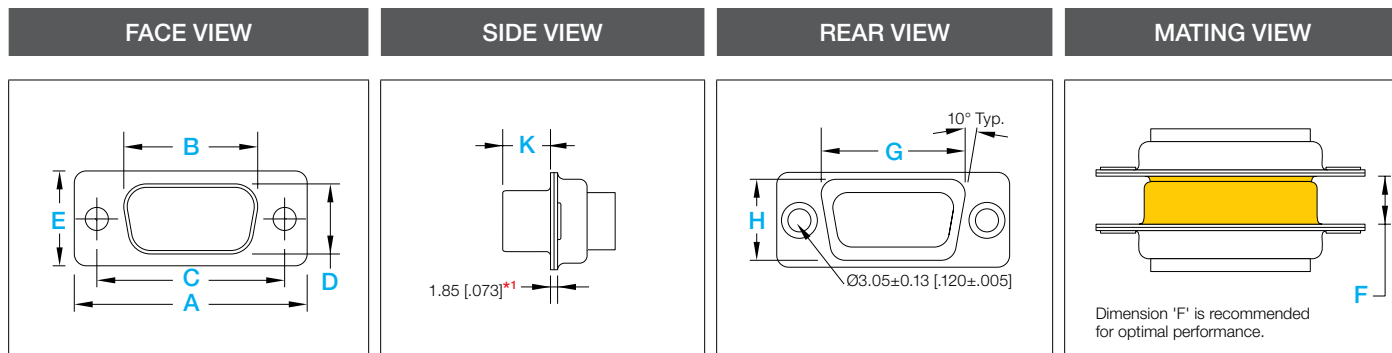

*1 The 1.85 [0.073] shell thickness in the SIDE VIEW is only valid for configurations without angle brackets.

SHELL SIZE	GENDER	A ±0.38 [.015]	B ±0.13 [.005]	C ±0.13 [.005]	D ±0.13 [.005]	E ±0.38 [.015]	G ±0.25 [.010]	H ±0.25 [.010]	K ±0.13 [.005]	F ±0.38 [.015]
1	Male	30.81 [1.213]	18.75 [.738]	24.99 [.984]	10.19 [.401]	12.55 [.494]	19.82 [.780]	10.82 [.426]	5.92 [.233]	6.73 [.265]
	Female		16.33 [.643]		7.90 [.311]				6.17 [.243]	
2	Male	39.14 [1.541]	27.08 [1.066]	33.32 [1.312]	10.19 [.401]	12.55 [.494]	28.15 [1.108]	10.82 [.426]	5.92 [.233]	6.73 [.265]
	Female		24.66 [.971]		7.90 [.311]				6.17 [.243]	
3	Male	53.04 [2.088]	40.79 [1.606]	47.04 [1.852]	10.19 [.401]	12.55 [.494]	41.87 [1.648]	10.82 [.426]	5.84 [.230]	6.50 [.256]
	Female		38.19 [1.504]		7.90 [.311]				6.17 [.243]	
4	Male	69.32 [2.729]	57.25 [2.254]	63.50 [2.500]	10.19 [.401]	12.55 [.494]	58.28 [2.294]	10.82 [.426]	5.84 [.230]	6.50 [.256]
	Female		54.84 [2.159]		7.90 [.311]				6.17 [.243]	
5	Male	66.93 [2.635]	54.64 [2.151]	61.11 [2.406]	13.03 [.513]	15.37 [.605]	55.88 [2.200]	13.67 [.538]	5.84 [.230]	6.50 [.256]
	Female		52.43 [2.064]		10.74 [.423]				6.17 [.243]	
6	Male	69.32 [2.729]	58.01 [2.284]	63.50 [2.500]	14.61 [.575]	16.97 [.668]	59.03 [2.324]	15.24 [.600]	5.84 [.230]	6.50 [.256]
	Female		55.60 [2.189]		12.32 [.485]				6.17 [.243]	

CONTACT TERMINATIONS

Solder Cup

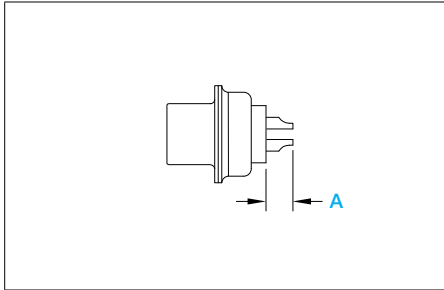

Straight Solder (Standard Density)

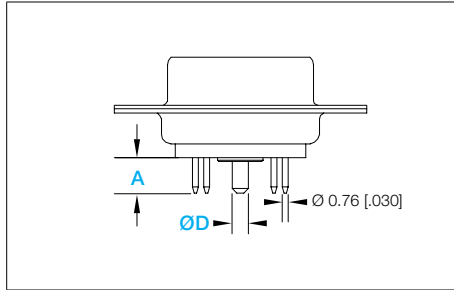

Straight Solder (High Density)

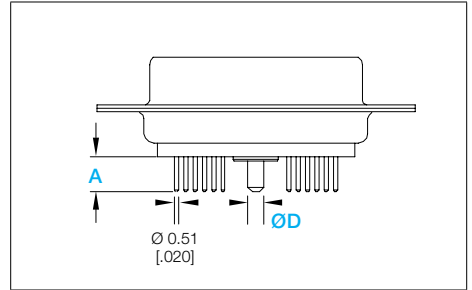

Straight Solder, code 65

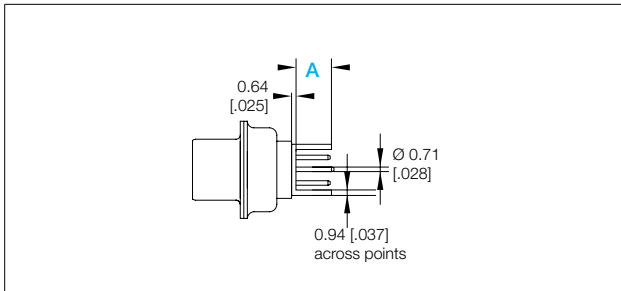

Code	Termination type	A	ØD Size 8
2	Solder cup	3.18 [.125]	--
3	Straight solder	4.32 [.170]	--
35	Straight solder	4.32 [.170]	1.98 [.078]
37	Straight solder	4.32 [.170]	3.18 [.125]
65	Straight solder	4.32 [.170]	--

CONTACT TERMINATIONS

See page 35 for PCB mounting hole locations.

Right Angle Solder, code 5, 55

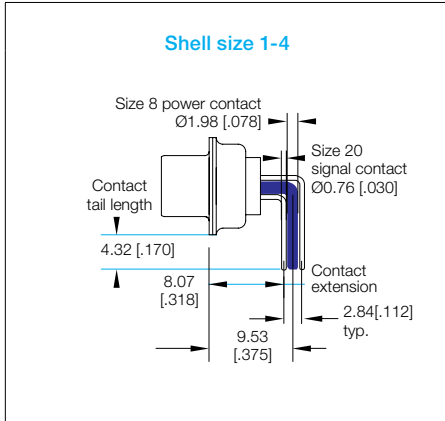

Right Angle Solder, code 5, 55

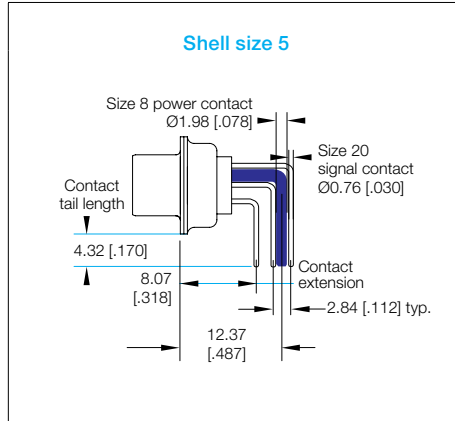

Right Angle Solder, code 5, 55

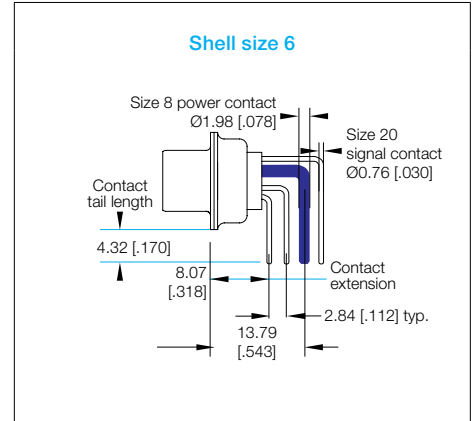

Right Angle Solder, code 5, 57

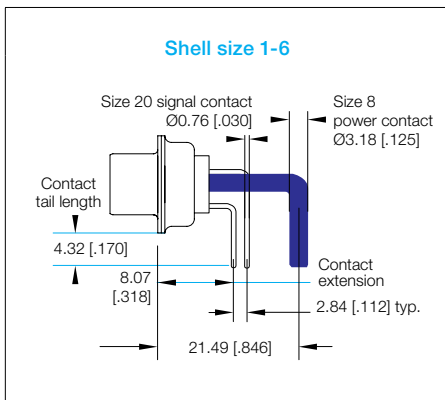

Right Angle Solder, code 7 and 75

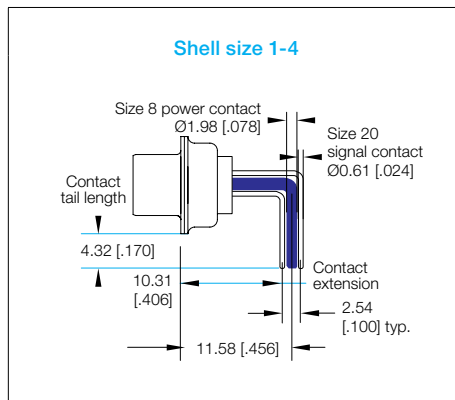

Right Angle Solder, code 7 and 75

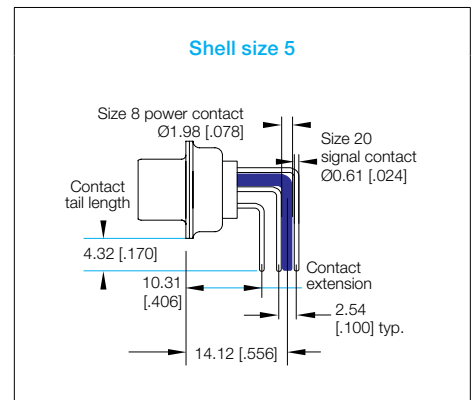

Right Angle Solder, code 7 and 77

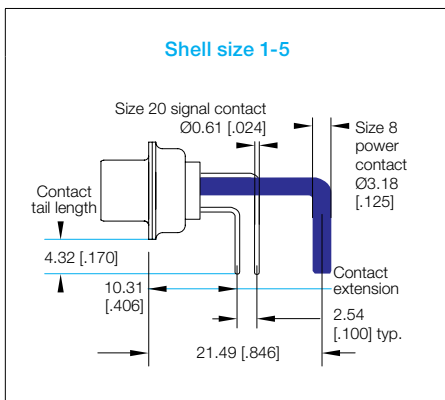

Right Angle Solder, code 85, shell size 1-5

With FRT4201D or MRT4201D shielded contacts

Shell size	A
1	8.07 [.318]
2	8.07 [.318]
3	8.07 [.318]
4	8.07 [.318]
5*	14.76 [.581]

* Supplied inverted, contact technical sales

CREATE A PART

For additional options and accessories, please see following page.

MCBX 17W2 S 55 R7 0 0 S /AA -15

Series
MCBX Combo-D

Layout

SHELL SIZE 1	SHELL SIZE 4
2WK2 (2) #8	8W8 (8) #8
5W1 (1) #8, (4) #20	13W6 (6) #8, (7) #20
	17W5 (5) #8, (12) #20
SHELL SIZE 2	21WA4 (4) #8, (17) #20
3W3 (3) #8	25W3 (3) #8, (22) #20
3WK3 (3) #8	27W2 (2) #8, (20) #20
7W2 (2) #8, (5) #20	
11W1 (1) #8, (10) #20	SHELL SIZE 5
	24W7 (7) #8, (17) #20
SHELL SIZE 3	36W4 (4) #8, (32) #20
5W5 (5) #8	43W2 (2) #8, (41) #20
9W4 (4) #8, (5) #20	47W1 (1) #8, (46) #20
13W3 (3) #8, (10) #20	
17W2 (2) #8, (15) #20	SHELL SIZE 6
21W1 (1) #8, (20) #20	46W4 (4) #8, (42) #20

Contact Gender

NEW M Male pin
MG Male pin with grounding strips
S Female socket

Termination

Other size 8 contact styles can be ordered separately - see Contacts section

0	Connector ordered without contacts
1	Wire, signal crimp contacts included
11	Crimp signal & MC/FC 4012D power contacts included
15	Crimp signal & MC/FC 4008D power contacts included
19	Wire, M39029 crimp contacts included, 20 - 24 AWG [0.50mm ² - 0.25mm ²].
2	Fixed solder cup, signal contacts only
3	Straight solder, signal contacts only, 4.32 [.170] tail length
35	Straight solder, signal and 1.98 [.078] Ø power contacts, 4.32 [.170] tail length
37	Straight solder, signal and 3.18 [.125] Ø power contacts, 4.32 [.170] tail length
5	Right angle solder, signal contacts only, 8.07 [3.18] signal contact extension
55	Right angle solder, signal and 1.98 [.078] Ø power contacts, 8.07 [3.18] signal contact extension
57	Right angle solder, signal and 3.18 [.125] Ø power contacts, 8.07 [3.18] signal contact extension
65	Straight solder, signal and size 8 shielded contacts, 4.32 [.170] tail length
85	Right angle solder, signal and size 8 shielded contacts, 8.07 [3.18] signal contact extension

Mounting Options

0	Clearance hole, 3.05 [.120] Ø
R2*1	Angle brackets integrated with shell, alignment bar with non-removable female jackposts
R6*1	Angle brackets integrated with shell, clearance hole, 3.05 [.120] Ø, alignment bar
R7*1	Angle brackets integrated with shell, 4-40 threaded hole, alignment bar
R8*1	Angle brackets integrated with shell, 4-40 locknut, alignment bar
S	Standoffs, swaged, 4-40
S5	Locknut, swaged, 4-40
S6	Standoffs, swaged, 4-40, boardlocks

Modifications

-XXXX See bottom of following page for typical modification options

Contact Plating

-15 50µin Au (min) over Ni over Cu
-50 50µin Au (min) over Cu

Environmental Compliance

/AA RoHS

Shells

K Aluminum, electroless nickel finish
S Stainless steel, passivated

Locking Systems

0	None
E5	Rotating male jackscrews internal hex
NEW K	Rotating male jackscrews, low-profile, internal hex, 36-position polarization (mates to S jackpost)
NEW S	Fixed female jackposts, 36-position polarization (mates to K jackscrew)
T2	Fixed female jackposts, washer set

All locking system options are compatible with EN and EJ backshells

Backshells & Boardlocks

0	None
C*2	Banding feature on rear shell, diamond knurl (eliminates the need for backshell)
NEW EN	Backshell, aluminum, top opening, machined, electroless nickel finish, grounding clips
N	Boardlocks, for use with R angle brackets in Mounting Options step

For additional options and accessories, please see following page.

*1 Alignment bar is not included for 2WK2, 3WK3, 3W3, 5W5, and 8W8 Layouts with right angle termination styles.

*2 Only available for use with Code 0, 1, 11, 12, 15 and 19 in Termination step

ADDITIONAL OPTIONS

Options shown on this page are less common than others. Customers may experience a price and/or lead time impact when selecting these options.

Additional Termination Options

- 12** Crimp signal & MC/FC 4016D power contacts included
- 36** Straight solder, signal and 2.39 [.094] Ø power contacts included, 4.32 [.170] tail length
- 7** Right angle solder, metric footprint, signal contacts included, 10.31 [.406] contact extension
- 75** Right angle solder, metric footprint, signal and 1.98 [.078] Ø power contacts included, 10.31 [.406] contact extension
- 77** Right angle solder, metric footprint, signal and 3.18 [.125] Ø power contacts included, 10.31 [.406] contact extension

Additional Backshell Options

- EJ** Backshell, aluminum, top opening, machined, chemical conversion coating, grounding clips

Additional Locking Systems Options

- T** Fixed female jackposts, compatible with EN and EJ backshells

Additional Shells Options

- T** Aluminum, chemical conversion coating
- U** Aluminum, cadmium finish - omit Code /AA from Environmental Compliance step when selecting this option

Typical Modification Options

- Low outgassing per ASTM E595 and ECSS-Q-ST-70-02C
- Solder coated contact tails
- Thermocouple contacts
- IP-rated waterproofing
- Blind mate hardware
- Protective dust caps
- EMI dust caps
- Panel mount with EMI O-ring
- ESD packaging
- 100% inspection or other increased inspection levels

Please contact Technical Sales for additional modification options not listed here and for part numbering details.

#20 & #22 SIGNAL CONTACTS

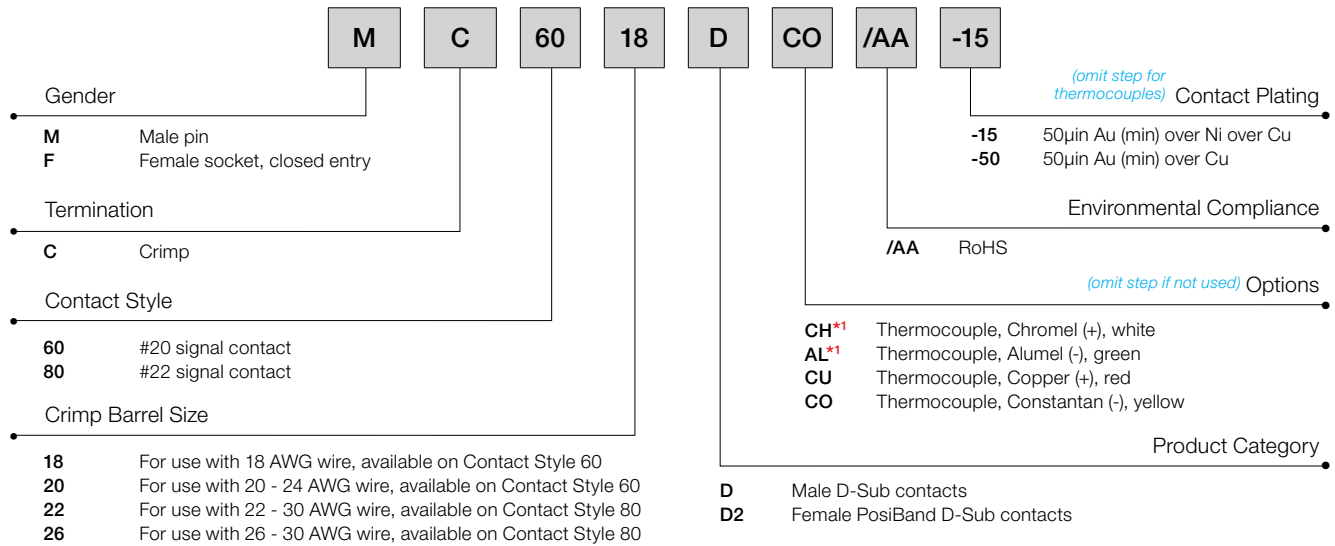

*1 Chromel® and Alumel® are registered trademarks of the Hoskins Manufacturing Company

M39029 MILITARY CONTACT PART NUMBERS

PART NUMBER	Series	Size	Gender	Female Contact Style	Stranded AWG [mm2]	Color Code	Plating	Type
M39029/57-354	MCDD, MCBX	#22	Female	Closed entry	#22-28 [.3 - .08]	Orange / Green / Yellow	50µin Au (min) over Ni	Crimp
M39029/58-360	MCDD, MCBX	#22	Male	n/a	#22-28 [.3 - .08]	Orange / Blue / Black	50µin Au (min) over Ni	Crimp
M39029/57-982	MCDD, MCBX	#22	Female	Closed entry	#22-28 [.3 - .08]	White / Gray / Red	50µin Au (min) over Cu	Crimp
M39029/58-986	MCDD, MCBX	#22	Male	n/a	#22-28 [.3 - .08]	White / Gray / Blue	50µin Au (min) over Cu	Crimp
M39029/63-368	MCD, MCBX	#20	Female	Closed entry	#20-24 [.5 - .25]	Orange / Blue / Gray	50µin Au (min) over Ni	Crimp
M39029/64-369	MCD, MCBX	#20	Male	n/a	#20-24 [.5 - .25]	Orange / Blue / White	50µin Au (min) over Ni	Crimp
M39029/63-928	MCD, MCBX	#20	Female	Closed entry	#20-24 [.5 - .25]	White / Red / Gray	50µin Au (min) over Cu	Crimp
M39029/64-968	MCD, MCBX	#20	Male	n/a	#20-24 [.5 - .25]	White / Blue/ Gray	50µin Au (min) over Cu	Crimp

Positronic is qualified to supply the legacy design, as well as the PosiBand design. If the requirement is for PosiBand-style female contacts, add "POSIBAND" to the end of the M39029 part number (e.g. M39029/57-354 POSIBAND).

#8 POWER CONTACTS

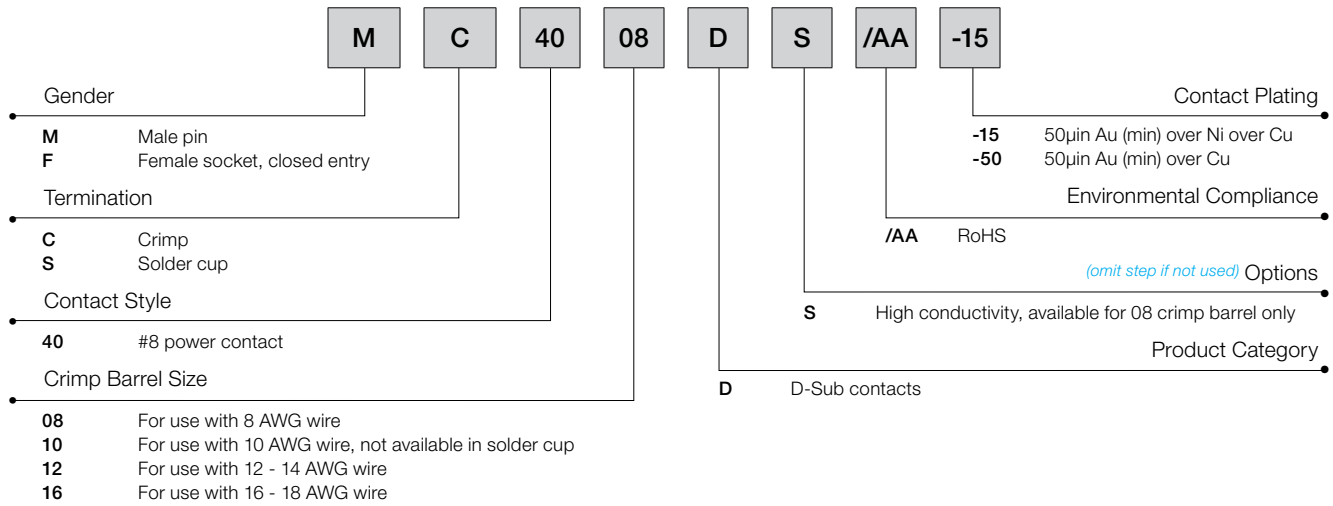

#8 HIGH VOLTAGE CONTACTS

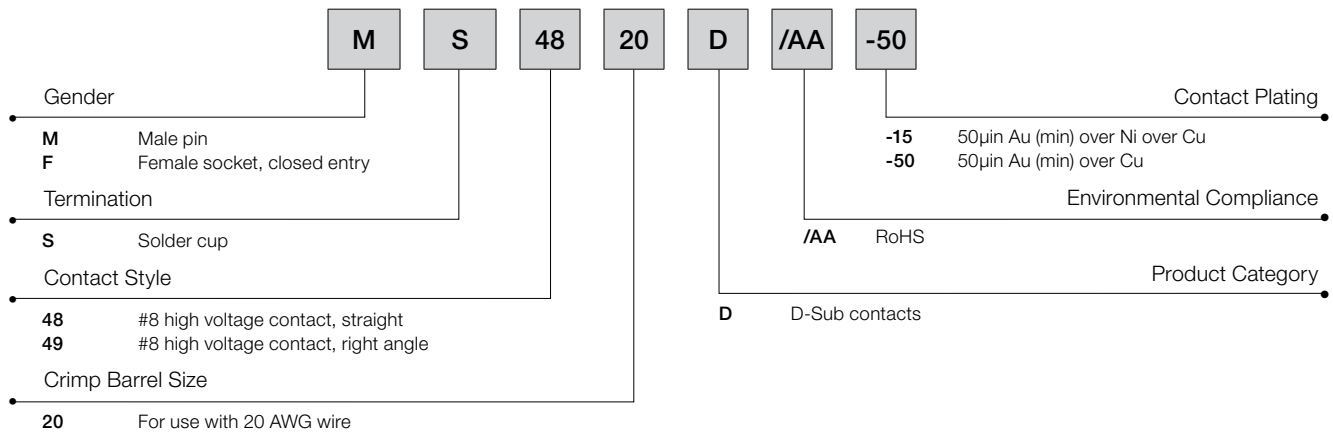

#8 COAX CONTACTS

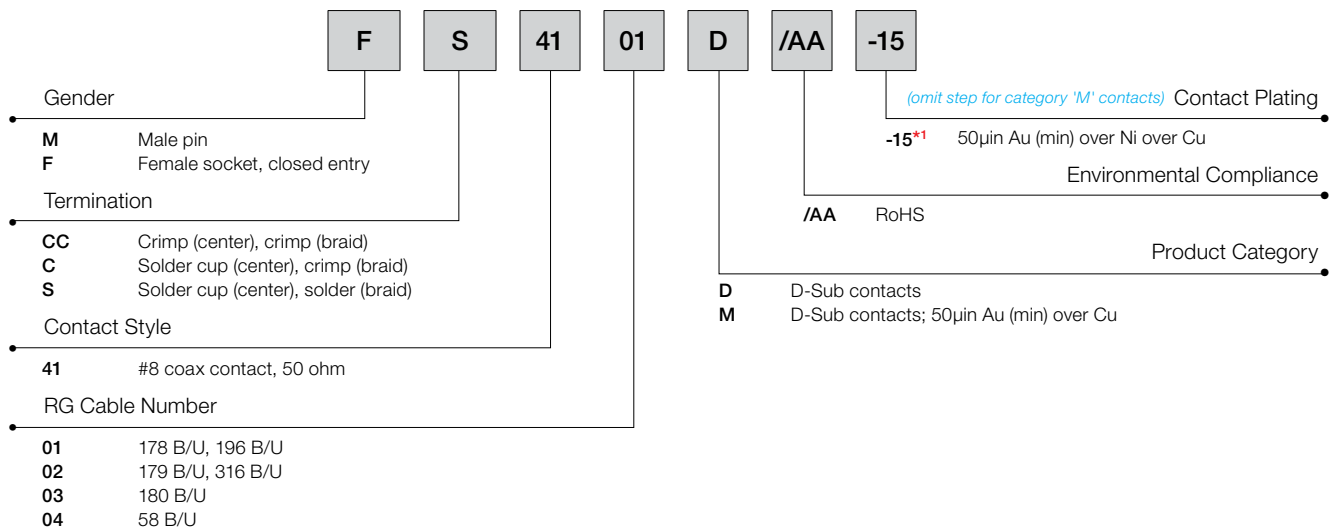

*1 Contact plating applies to center conductor only.
Braid conductor is plated 30µin Au (min) over Ni over Cu.

BACKSHELLS & BOARDLOCKS

C

Banding feature on rear shell, diamond knurl (eliminates the need for backshell)

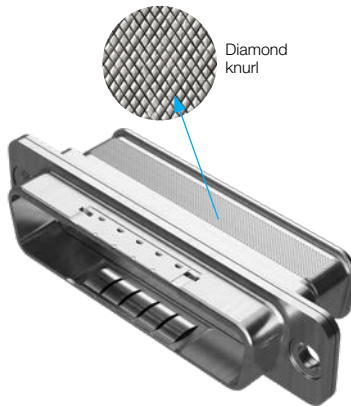

EN

Backshell, aluminum, top opening, machined, electroless nickel finish, grounding clips



EJ

Backshell, aluminum, top opening, machined, chemical conversion coating, grounding clips



N

Boardlocks, for use with angle brackets

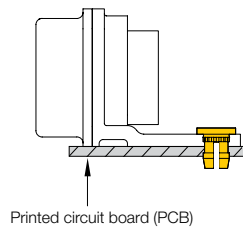

EN Backshell shown here

PANEL MOUNT SEALING FLANGE

P

IP67-rated inside panel mount flange, O-ring^{*1}, for use with C options in Mounting Options

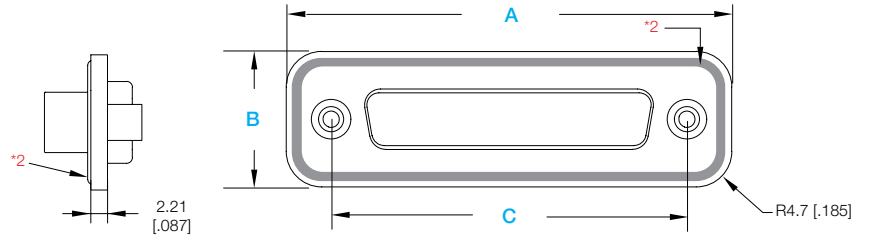

SHELL SIZE	A ±0.25 [D±.010]	B ±0.25 [D±.010]	C ±0.13 [.005]
1	36.68 [1.444]	17.88 [0.704]	24.99 [0.984]
2	45.01 [1.772]	17.88 [0.704]	33.32 [1.312]
3	58.90 [2.319]	17.88 [0.704]	47.04 [1.852]
4	75.18 [2.960]	17.88 [0.704]	63.50 [2.500]
5	72.80 [2.866]	20.70 [0.815]	61.11 [2.406]
6	75.18 [2.960]	22.30 [0.878]	63.50 [2.500]

*1 Standard O-ring material: CHOFORM 5513 Ag/Cu filled silicone (form-in-place, non-removable)

*2 O-ring groove dimensions compatible with Spira-Shield SS-02 metal EMI gasketing

Panel Cutout Dimensions

SHELL SIZE	A	B	C
1	20.47 [0.806]	11.40 [0.449]	24.99 [0.984]
2	28.80 [1.134]	11.40 [0.449]	33.32 [1.312]
3	42.52 [1.674]	11.40 [0.449]	47.04 [1.852]
4	59.08 [2.326]	11.40 [0.449]	63.50 [2.500]
5	56.34 [2.218]	14.10 [0.555]	61.11 [2.406]
6	59.51 [2.343]	15.67 [0.617]	63.50 [2.500]

INSIDE PANET MOUNT

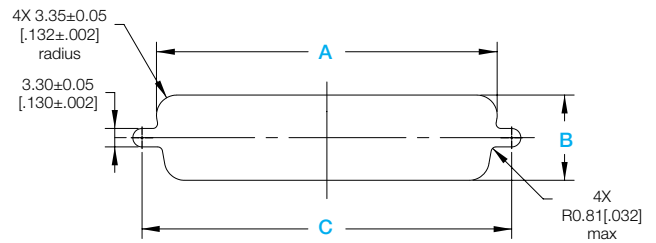

For panel cutout details for use with code S keyed jackposts, contact Technical Sales.

MOUNTING OPTIONS

C5 IP67-rated inside wall mount, standoffs, for use with termination codes 2 and 3

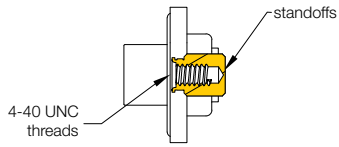

C6 IP67-rated inside wall mount, integrated angle brackets, alignment bar, for use with right-angle PCB termination types

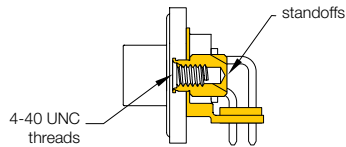

C7 IP67-rated inside wall mount, integrated angle brackets with boardlocks, alignment bar, for use with right-angle PCB termination types

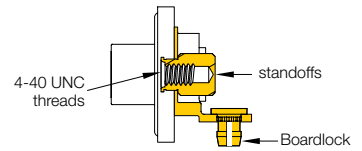

C8 IP67-rated inside wall mount, standoffs with boardlocks, for use with straight PCB termination types

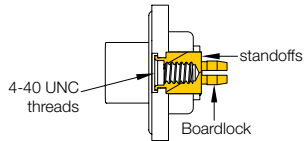

R2 Angle brackets integrated with shell, alignment bar with non-removable female jackposts

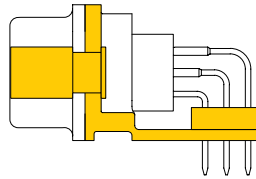

R6 Angle brackets, integrated with shell, clearance hole, 3.05 [120] Ø, alignment bar

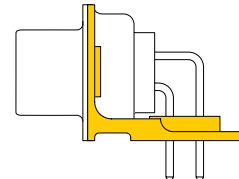

R7 Angle brackets, integrated with shell, 4-40 threaded hole, alignment bar

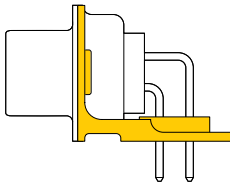

R8 Angle brackets, integrated with shell, 4-40 locknut, alignment bar

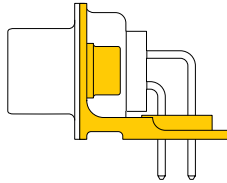

S Standoffs, swaged, 4-40

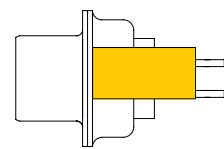

S5 Locknut, swaged, 4-40

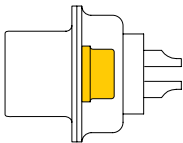

S6 Standoffs, swaged, 4-40, boardlocks

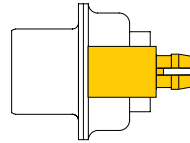

LOCKING SYSTEMS

E5 Rotating male jackscrews internal hex

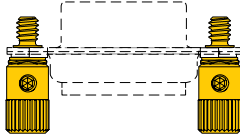

T Fixed female jackposts



T2 Fixed female jackposts, washer set

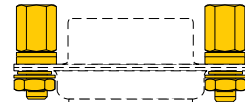

K Rotating male jackscrews, low-profile, internal hex, 36-position polarization (mates to S jackpost)



S Fixed female jackposts, 36-position polarization (mates to K and E5 jackscrews)

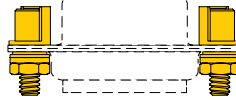

MOUNTING HOLE FOR ANGLE BRACKET

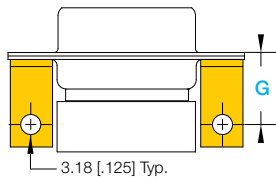

SERIES	Termination Code	Shell size					
		1	2	3	4	5	6
		G ± 0.25 [.010]					
MCD	4	13.76 [.542]			15.18 [.598]		
	42	11.58 [.456]			12.85 [.506]		
	5/51/52/53/54	9.44 [.372]			10.87 [.428]		
MCDD	4	14.24 [.561]			15.39 [.606]		16.43 [.647]
	51/52	10.06 [.396]			11.20 [.441]		12.11 [.477]
MCBX	5/55/57/85	9.44 [.372]			10.87 [.428]		12.36 [.487]
	7/75/77	11.58 [.456]			12.85 [.506]		13.89 [.547]

TEST DATA

The following tests have been conducted using applicable configurations of MCD, MCDD, and MCBX Series connectors:

Test	Test Condition	Criteria	Results
Contact Retention	MIL-DTL-24308J	Signal contacts: 9 pound axial force, each direction	Pass
	EIA-364-29	Power contacts: 22 pounds axial force, each direction	
Dielectric Withstanding Voltage	MIL-DTL-24308J @ sea level	1000V	Pass
	MIL-DTL-24308J @ 70000 ft-equivalent	325V	
Insulation Resistance	MIL-DTL-24308J EIA-364-21	5 GΩ	Pass
Contact Resistance	MIL-DTL-24308J EIA-364-06	Per MIL-DTL-24308J Table VI	Pass
Temperature Cycling	MIL-DTL-24308J EIA-364-32, condition I (5 cycles) @ -55°C to 155°C	Connector verified with DWV, insulation resistance, mating/unmating	Pass
Humidity	MIL-DTL-24308J EIA-364-31, method IV	Connector verified with DWV, insulation resistance	Pass
Vibration	MIL-DTL-24308J EIA-364-28, test condition IV (sinusoidal) 10-2000 Hz, 20 g peak	No signal discontinuity longer than 1 μs, no damage	Pass
	MIL-DTL-24308J EIA-364-28, test condition VI, letter J (random) 50-2000 Hz, 1.0 g ² /Hz, 43.92 g RMS	No signal discontinuity longer than 1 μs, no damage	
Shock	MIL-DTL-24308J EIA-364-27, test condition E	No signal discontinuity longer than 1 μs, no damage	Pass
Durability	MIL-DTL-24308J EIA-364-09	500 mating cycles	Pass
	EIA-364-09 (extreme lifespan)	10000 mating cycles	
Salt Spray	MIL-DTL-24308J EIA-364-26, test condition A	96 hours (Code T shell plating)	Pass
	MIL-DTL-24308J EIA-364-26, test condition C	500 hours (Code K, S, U shell platings)	
Magnetic Permeability	ASTM A342/A342M	≤ 2μ	Pass
Residual Magnetism	Goddard S-311 Level C (GSFC NMC)	≤ 20 gamma	Pass
Outgassing	ASTM E595, ECSS-Q-ST-70-02C	TML <1.0%, CVCM <0.1%, RML <1.0%	Pass

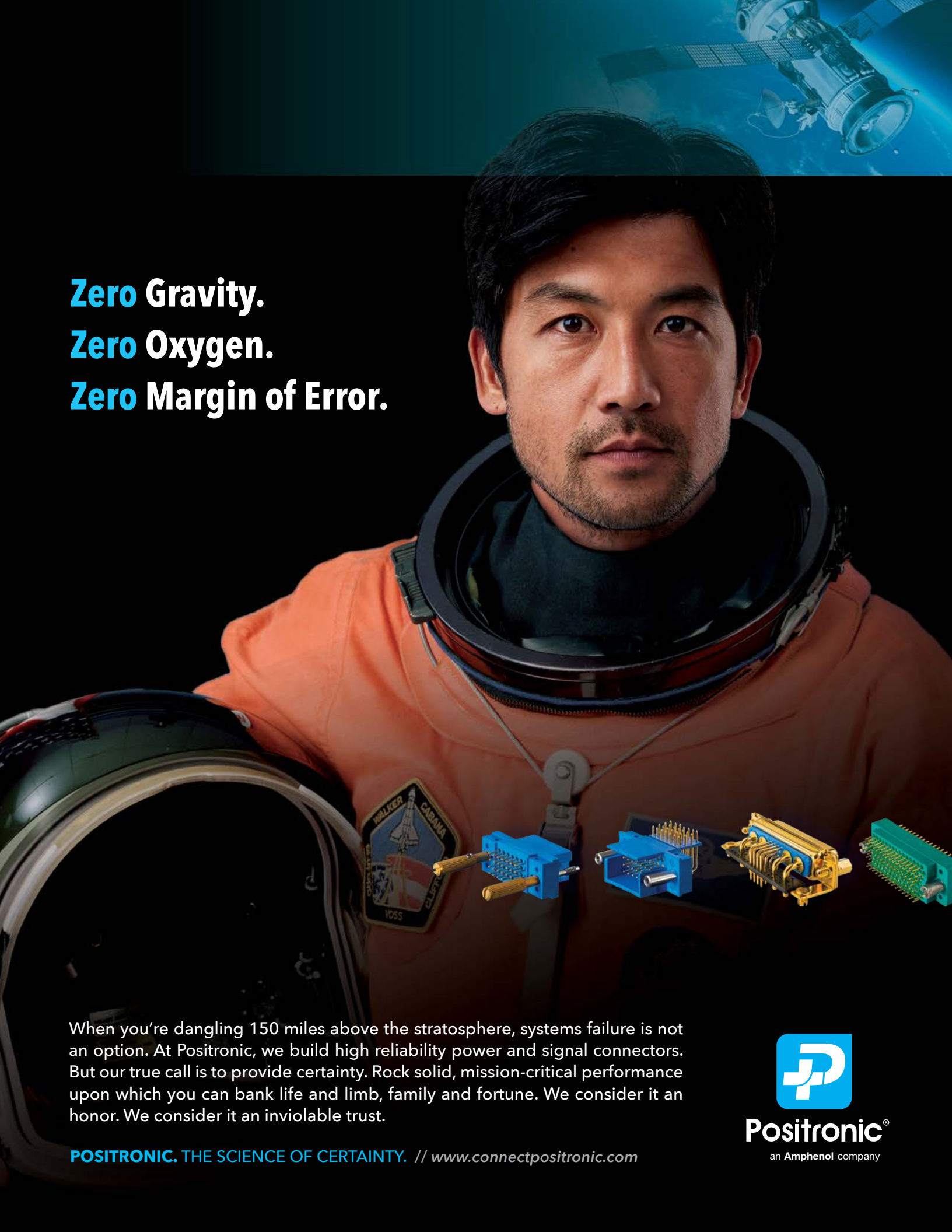

Zero Gravity.
Zero Oxygen.
Zero Margin of Error.

When you're dangling 150 miles above the stratosphere, systems failure is not an option. At Positronic, we build high reliability power and signal connectors. But our true call is to provide certainty. Rock solid, mission-critical performance upon which you can bank life and limb, family and fortune. We consider it an honor. We consider it an inviolable trust.

POSITRONIC. THE SCIENCE OF CERTAINTY. // www.connectpositronic.com



Positronic[®]
an Amphenol company



22 Mile Patrol.
6 Roadside IEDs.
Zero Margin of Error.







When it's your job to detect and disarm concealed explosives, systems failure is not an option. At Positronic, we build high reliability power and signal connectors. But our true call is to provide certainty. Rock solid, mission-critical performance upon which you can bank life and limb, family, fortune, freedom. We consider it an honor. We consider it an inviolable trust.

POSITRONIC. THE SCIENCE OF CERTAINTY. // www.connectpositronic.com



Positronic®
an Amphenol company

See connectpositronic.com/machd
for all other MACH-D-related
information including:

- ✓ **Footprints** 
- ✓ **Tooling** 
- ✓ **Product updates** 
- ✓ **Detailed dimensions** 
- ✓ **2D/3D drawings** 

All dimensional tolerances are ± 0.38 [0.015], unless otherwise specified. Dimensions are in millimeters [inches]. All dimensions are subject to change. Product pictures may not be identical in appearance to actual production parts.

Information in this catalog is proprietary to Positronic and its subsidiaries. Positronic believes the data contained herein to be reliable. Since the technical information is given free of charge, the user employs such information at his own discretion and risk. Positronic assumes no responsibility for results obtained or damages incurred from use of such information in whole or in part.

The following trademarks are owned by Positronic Industries, Inc.: Positronic Industries, Inc.®, Positronic®, Connector Excellence®, P+ logo®, PosiBand®, PosiShop®, Optik-D™, and The Science of Certainty®. The color blue as it appears on various connectors is a trademark of Positronic Industries, Inc., Registered in U.S. Patent and Trademark Office.

Products described within this catalog may be protected by one or more of the following US patents:

#4,900,261 #5,255,580 #5,329,697 #6,260,268
#6,835,079 #7,115,002 #8,944,697 #9,304,263

Patented in Canada, 1992 Other patents pending

Federal Supply Code for Manufacturers

Positronic Industries: 28198
Positronic Industries SAS: FA7Y0
Positronic Asia PTE LTD: QB952

Positronic | Americas

1325 N Eldon Ave
Springfield MO 65803 USA
+1 800 641 4054
info@connectpositronic.com

Positronic | Europe

46 route d'Engachies
F-32020 Auch Cedex 9 France
+33 5 6263 4491
contact@connectpositronic.com

Positronic | Asia

3014A Ubi Rd 1 #07-01
Singapore 408703
+65 6842 1419
singapore@connectpositronic.com

Sales Offices

Positronic has local sales representation all over the world. For the nearest sales office visit www.connectpositronic.com/sales