

# POWER CONNECTION SYSTEMS

Power Connectors



**Positronic**<sup>®</sup>  
an Amphenol company

**VERSATILE, HIGH-CURRENT,  
MIXED DENSITY**

# Connector Excellence<sup>®</sup>

## Positronic Provides Complete Capability

### Mission Statement

*"To utilize product flexibility and application assistance to present quality interconnect solutions which represent value to customers worldwide."*

### Experience

- Founded in **1966**
- **Involvement** in the development of international connector specifications through EIA<sup>®</sup>, IEC and ISO as well as PICMG<sup>®</sup>.
- Introduction of new and **unique connector products** to the electronics industry.
- Patent holder for many **unique connector features and manufacturing techniques**.
- **Vertically integrated** manufacturing – raw materials to finished connectors.

### Technology

- **Expertise** with solid machined contacts provides a variety of high reliability connectors including high current density power connectors.
- Quality Assurance lab is **capable of testing** to IEC, EIA, UL, CUL, military and customer-specified requirements.
- **In-house design and development** of connectors based on market need or individual customer requirements.
- **Internal manufacturing capabilities** include automatic precision contact machining, injection molding, stamping, plating operations and connector assembly.
- **Manufacturing locations** in southwest Missouri, U.S.A. (headquarters); Puerto Rico, France, China, Singapore, and India. Total square footage: 407,441.

### Support

- **Quality Systems:** Select locations qualified to ISO 9001, ISO 14001, AS9100, MIL-STD-790 and customer "dock to stock" programs. Applicable products qualified to MIL-DTL-24308, SAE AS39029, DSCC 85039, MIL-DTL-28748, Space D32, GSFC S-311-P-4 and GSFC S-311-P-10.
- Compliance to a variety of international and customer specific **environmental requirements**.
- Large **in-house inventory** of finished connectors. Customer specific **stocking programs**.
- Factory direct **technical sales support** in major cities worldwide.
- **One-on-one customer support** from worldwide factory locations.
- World class **web site**.
- **Value-added solutions** and willingness to **develop custom products** with reasonable price and delivery.



### Regional Headquarters

Springfield, MO



Auch, France



Singapore



Products described within this catalog may be protected by one or more of the following US patents:

#4,900,261<sup>†</sup> #5,255,580 #5,329,697  
#6,260,268 #6,835,079 #7,115,002

<sup>†</sup>Patented in Canada, 1992 Other Patents Pending

Positronic Industries' **FEDERAL SUPPLY CODE** (Cage Code)  
FOR MANUFACTURERS is **28198**

Unless otherwise specified, **dimensional tolerances** are:

- 1)  $\pm 0.001$  inches [0.03 mm] for male contact mating diameters.
- 2)  $\pm 0.003$  inches [0.08 mm] for contact termination diameters.
- 3)  $\pm 0.005$  inches [0.13 mm] for all other diameters.
- 4)  $\pm 0.015$  inches [0.38 mm] for all other dimensions.

POSITRONIC<sup>®</sup> IS AN ITAR REGISTERED COMPANY

Information in this catalog is proprietary to Positronic and its subsidiaries. Positronic believes the data contained herein to be reliable. Since the technical information is given free of charge, the user employs such information at his own discretion and risk. Positronic Industries assumes no responsibility for results obtained or damages incurred from use of such information in whole or in part.

The following trademarks are registered to Positronic Industries, Inc. in the United States and many other countries: Positronic Industries, Inc.<sup>®</sup>, Positronic<sup>®</sup>, Connector Excellence<sup>®</sup>, P+ logo<sup>®</sup>, PosiBand<sup>®</sup>, PosiShop<sup>®</sup>, Positronic Global Connector Solutions<sup>®</sup>, Global Connector Solutions<sup>®</sup>. The color blue as it appears on various connectors is a trademark of Positronic Industries, Inc., Registered in U.S. Patent and Trademark Office.

# Proven Performance

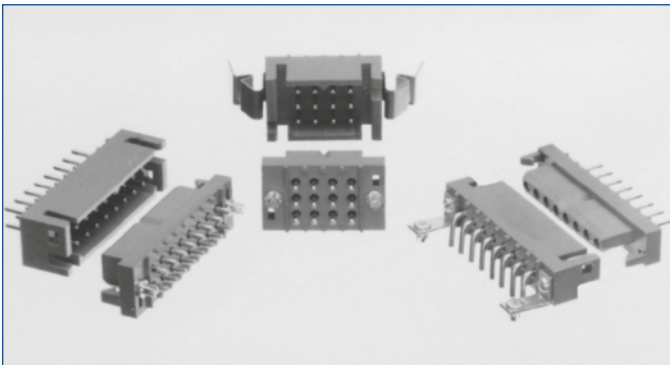
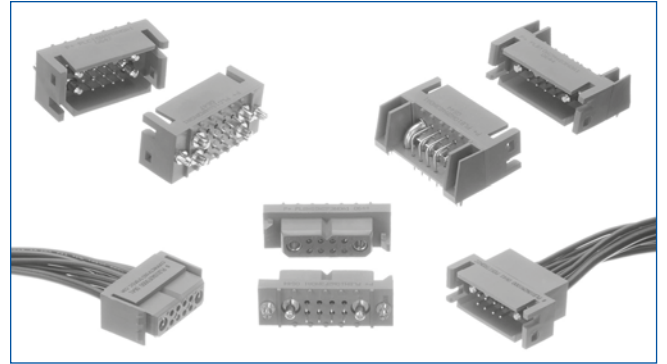
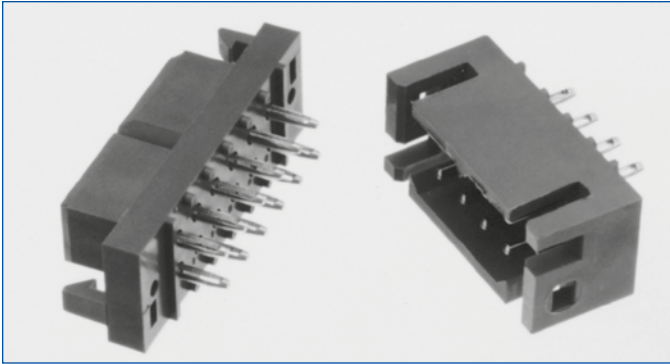

In 1989, Positronic Introduced the Power Connection Systems series. Since that time PCS has been the power connector of choice in a wide variety of applications. The popularity of PCS is due to a growing list of features, they include:

**\*\*Low Contact Resistance\*\***

**\*\*Sequential Mating Options\*\***

**\*\*Discriminating Locking System\*\***

**\*\*Board to Board / Board - Cable / Cable - Cable\*\***

**\*\*Size 12 Contacts with Screw Terminations\*\***

**\*\*Safety Shrouded Options\*\***

**\*\*Many Connector Variants Available From Stock\*\***

**\*\*Mixed Density Variants\*\***

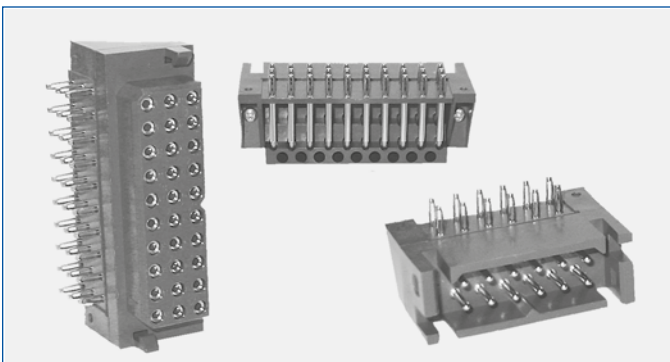
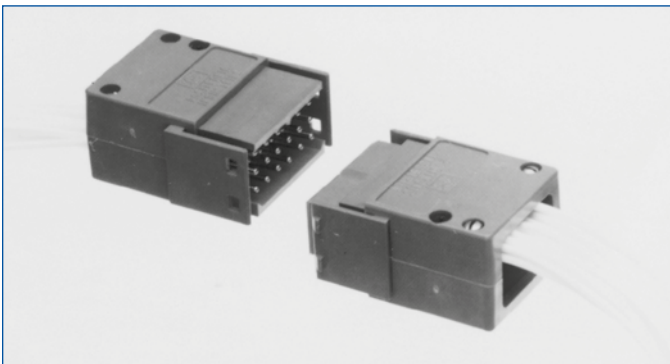



GENERAL INFORMATION

## GENERAL INFORMATION

Typical Connection Systems .....	iv-3
Demystifying Current Ratings .....	4
Large Surface Area Contact Mating System .....	5
Compliant Terminations .....	6

PCS SERIES

## PCS SERIES

Customer Specified Arrangements .....	7
Technical Information .....	8
Temperature Rise Curves .....	9
Mating Dimensions .....	10
Straight Solder Printed Board Connectors .....	11-12
Compliant Press-in Power Connectors .....	13
Straight Solder And Compliant Contact Hole Pattern .....	14-15
Right Angle (90°) Solder Printed Board Connectors .....	16-17
Right Angle (90°) Press-in Connectors .....	18
Right Angle (90°) Printed Board Contact Hole Pattern .....	19-20
Panel Mount Connectors with Solder Cup Contacts .....	20
Cable Connectors with Removable Contacts .....	21-22
Panel Mount Connectors with Removable Contacts .....	23-24
Sequential Mating System .....	25
Ordering Information .....	26

SAFETY SHROUD

## SAFETY SHROUD SERIES

Technical Information .....	27
Connector Systems and Cable Connector .....	28
Panel Mount Connector .....	29
Straight Solder and Right Angle (90°) Solder Printed Board Mount Connector .....	30
Ordering Information .....	31

POWER INPUT

## POWER INPUT SERIES

Technical Information .....	32
Connection Systems and Temperature Rises Curves .....	33
Cable and Panel Mount Connector .....	34
Straight Solder Printed Board Mount, Compliant Press-in Connector, and Contact Hole Pattern .....	35
Right Angle (90°) Printed Board Mount Connector and Contact Hole Pattern .....	36
Screw Termination and Sequential Mating Contacts .....	37
Ordering Information .....	38



**P C S M I X E D D E N S I T Y S E R I E S**

Technical Information.....	39-40
Temperature Rises Curves.....	40
Cable Connector.....	41
Panel Mount Connector.....	42
Straight Printed Board Mount Connector and Contact Hole Pattern.....	43
Right Angle (90°) Printed Board Mount Connector and Contact Hole Pattern.....	44
Compliant Press-in Connector.....	45
Ordering Information.....	46

**R E M O V A B L E C O N T A C T**

Removable Contact Technical Information.....	47
Removable Contact Technical Information and Removable Crimp Signal Contact Size 20.....	48
Removable Crimp Contact and Solder Cup Contact Size 16.....	49
Removable Shielded Contact Size 16 and Removable Crimp Contact Size 12.....	50
Removable Solder Cup Contact Size 12 and Removable Crimp Contact Size 8.....	51
Removable Solder Cup and Removable High Voltage Contact Size 8.....	52
Removable Shielded Contact Size 8.....	53

**A P P L I C A T I O N T O O L S**

Introduction.....	54
Contact Application Tools Cross Reference List.....	55
Press-in User Information and Connector Installation Tooling.....	56
Compliant Press-in Connectors Printed Board Hole Sizes.....	57

**A C C E S S O R I E S**

Right Angle (90°) Metal and Plastic Mounting Brackets.....	58
Push-on Fasteners and Mounting Screws.....	59
Connector Hoods.....	60
Quick Release Mounting Clip and Panel Cutout.....	61
Fixed Style Mounting Clip and Panel Cutout.....	62
Panel Mount Cutout.....	63
Blind Mating System and Panel Cutout.....	64

*Visit our website for the latest catalog updates and supplements at <https://www.connectpositronic.com/family/power-connection-system/>*



Positronic  
connectpositronic.com

# PRINTED BOARD TO PRINTED BOARD CONNECTION SYSTEMS

Power  
Connection  
Systems

## SYSTEM 1 MOTHER BOARD- DAUGHTER BOARD

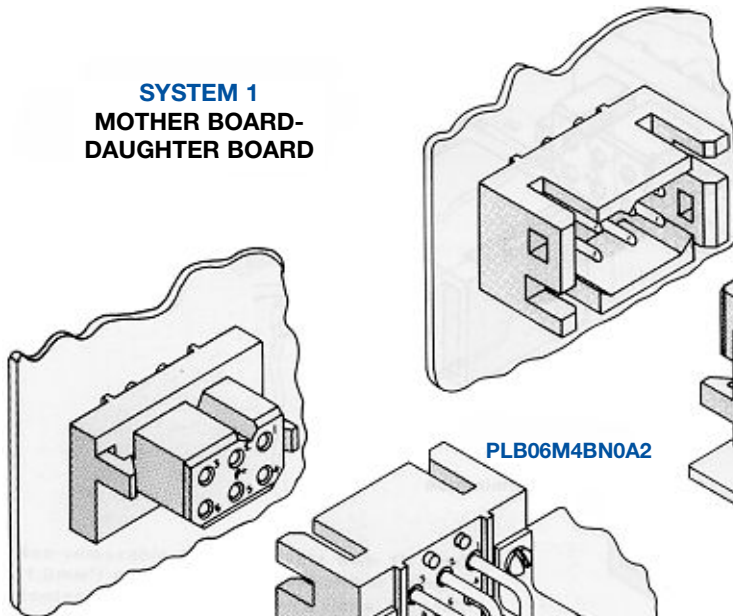

PLB06M300A1 Straight solder or  
PLB06M92ST20A1 Compliant  
termination press-in

PLB06F300A1 Straight  
solder or  
PLB06F94ST40A1  
Compliant termination  
press-in

PLB06M4BN0A2

PLB06F4BN0A1

## SYSTEM 2 SIDE TO SIDE BOARD MOUNTING

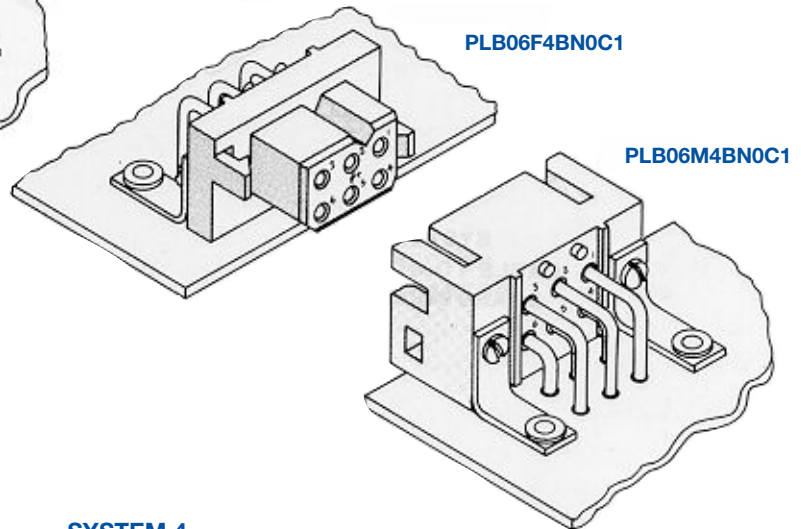

PLB06F4BN0C1

PLB06M4BN0C1

## SYSTEM 3 STACKABLE BOARD MOUNTING

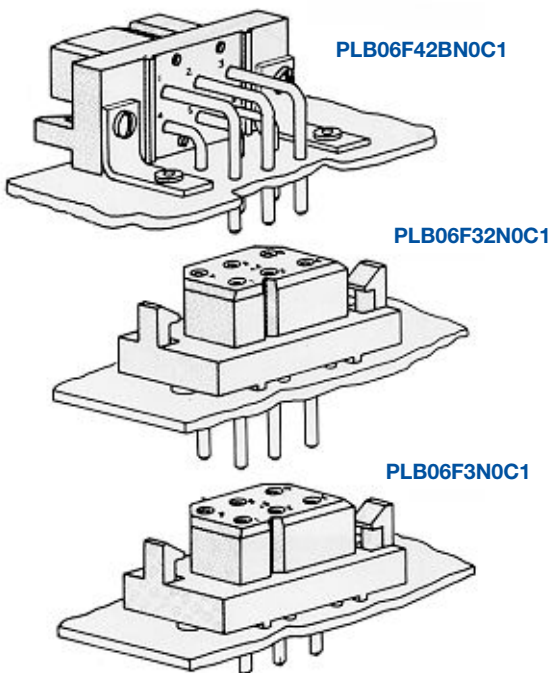

PLB06F42BN0C1

PLB06F32N0C1

PLB06F3N0C1

## SYSTEM 4 SANDWICH BOARD MOUNTING

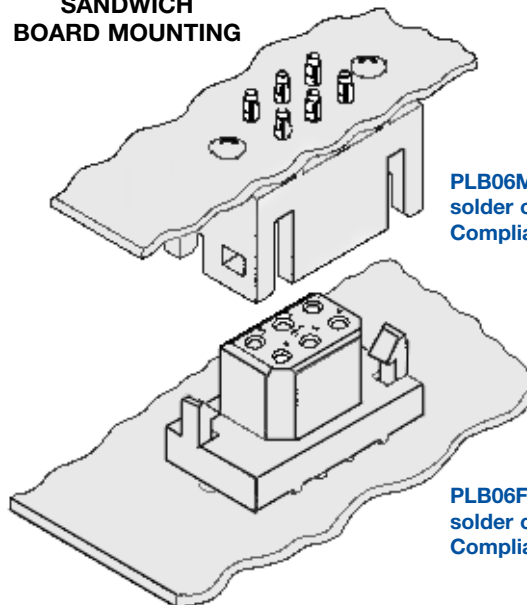

PLB06M300A1 Straight  
solder or PLB06M93ST30A1  
Compliant termination press-in

PLB06F300A1 Straight  
solder or PLB06F93ST30A1  
Compliant termination press-in



### SYSTEM 5 CABLE TO RIGHT ANGLE (90°) BOARD MOUNTING

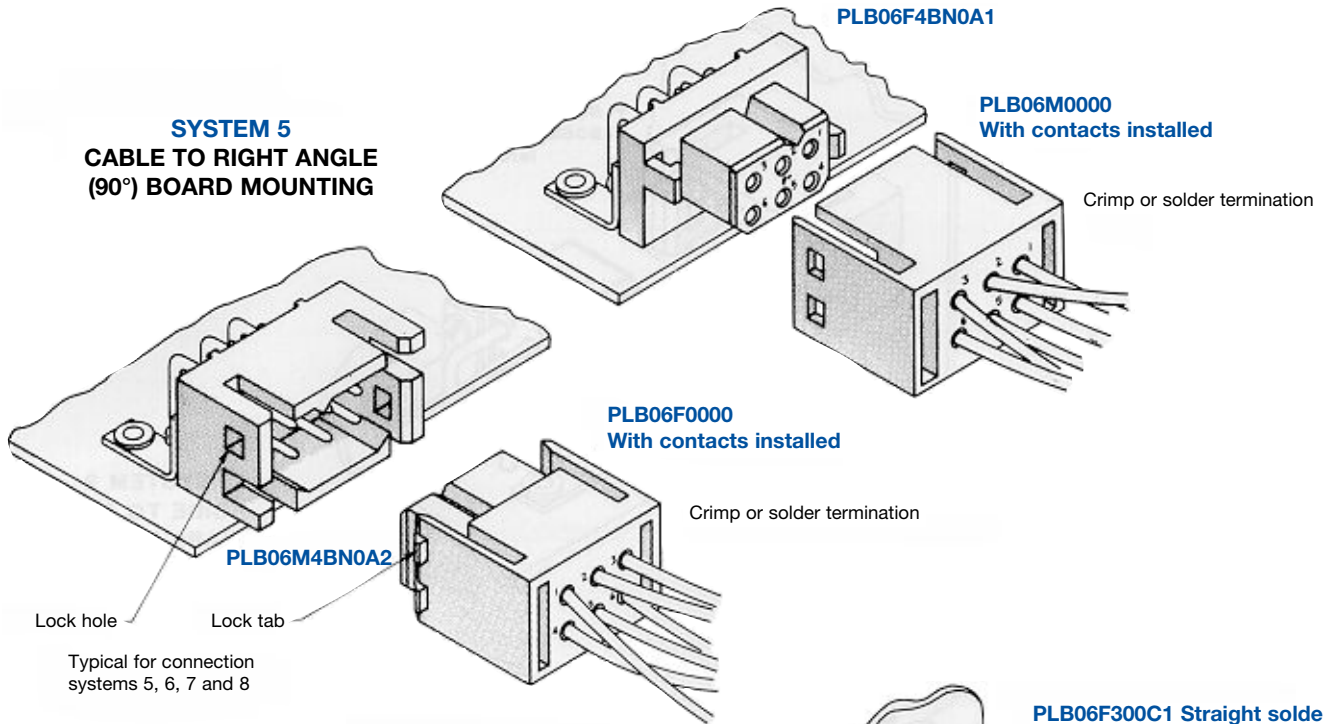

### SYSTEM 6 CABLE TO STRAIGHT BOARD MOUNTING

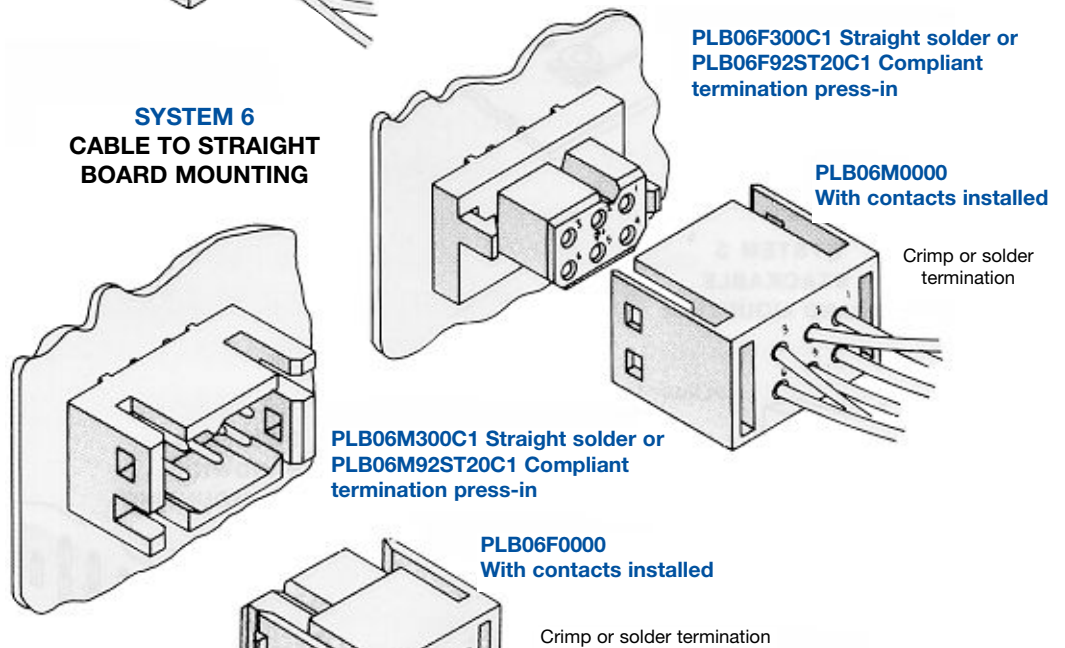

### SYSTEM 7 CABLE TO CABLE

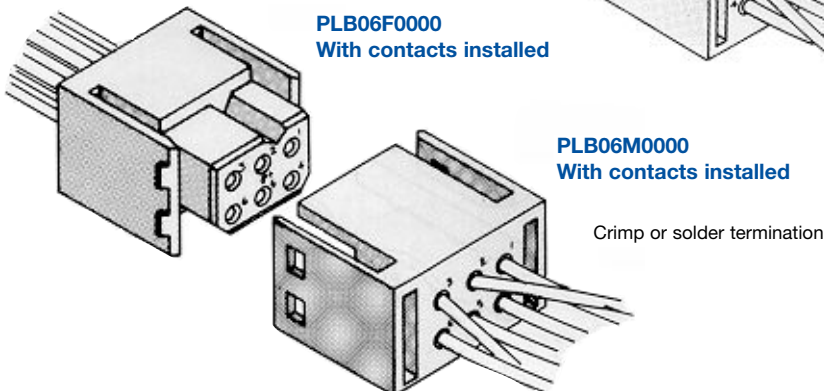



Positronic  
connectpositronic.com

# PANEL MOUNT & CABLE ADAPTERS CONNECTION SYSTEMS

Power  
Connection  
Systems

## SYSTEM 8 PANEL MOUNTED TO CABLE

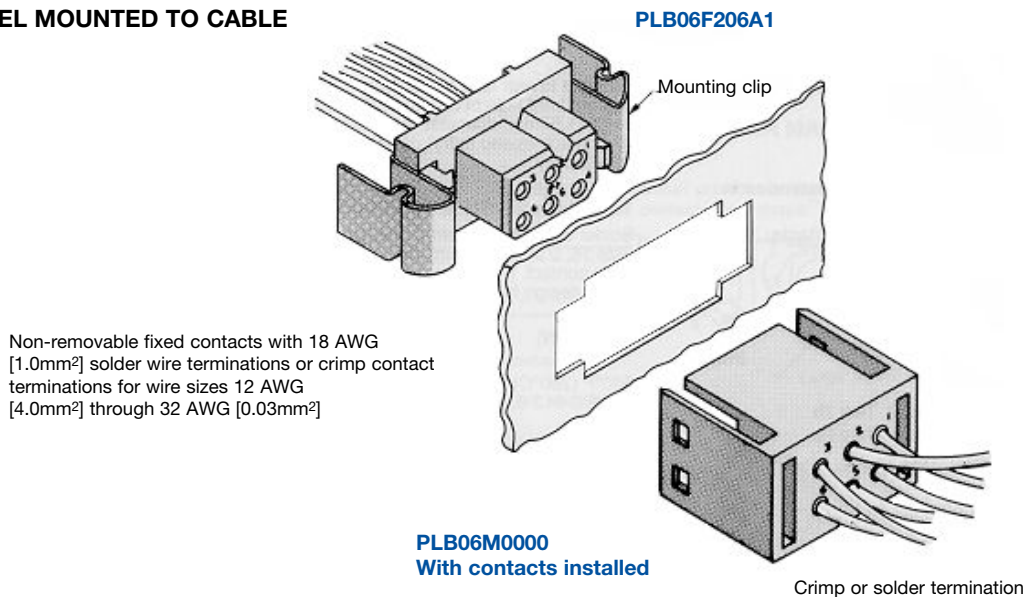

## SYSTEM 9 CABLE CONNECTOR WITH CABLE ADAPTER

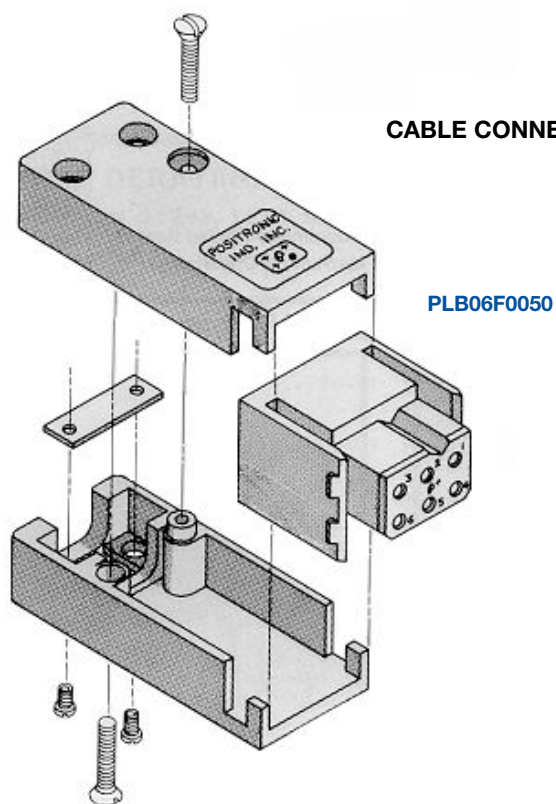



## INTEGRAL FEED THROUGH CONNECTION SYSTEM ALLOWS THREE WAY INTERFACE

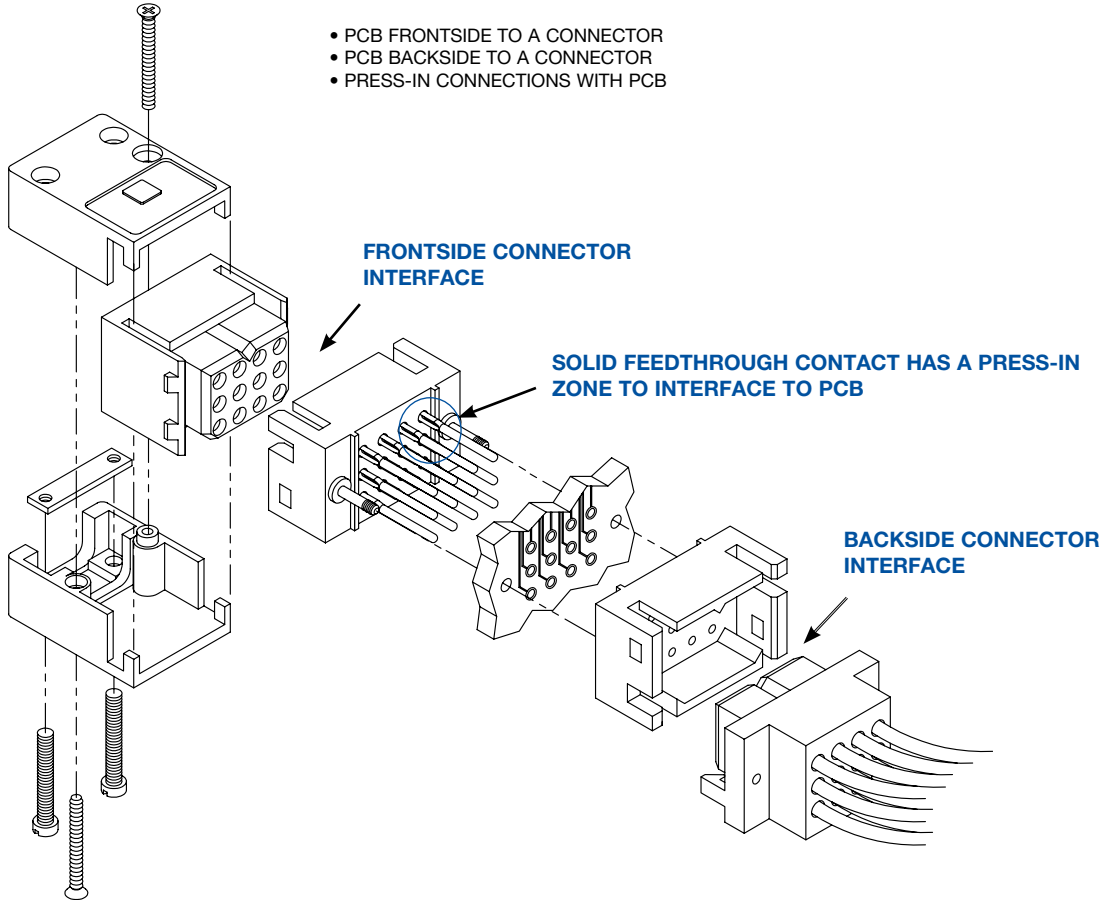

CONTACT TECHNICAL SALES FOR MORE INFORMATION.



## DEMISTIFYING CURRENT RATINGS

Connector current ratings seem to be shrouded in mystery at times. The user wonders how a listed current rating is relevant to a particular application. Perhaps more mysterious is how similar connectors from various manufacturers list different current rating values. While it is true that material choices and design can enhance a connector's current rating, the test method by which the rating was developed must be understood when evaluations are made.

Users of connectors for power applications are entitled to current rating test details in order to make an informed choice. Ideally, a connector's current rating should be developed within the application for which it is being considered. Although ideal, this approach is not always practical given the many differing applications. In order for connector manufacturers to give potential product users an idea of what can be expected, connectors are given current ratings based on a specific test method.

A wide variety of test methods are employed in order to develop current ratings for connectors. Some of these methods come from standards that are recognized industry-wide, while others are unique to the manufacturer or user. These various test methods can produce different results for the same product. It is no wonder confusion sometimes results.

There are key factors that, when understood, can help in choosing the right power connector. All test methods used to rate current have similarities; however, there are variables in applying the test methods which explain differing results.

Current ratings are usually established by first developing a temperature rise curve. This curve plots temperature rise against increasing current levels. The curve is a reliable tool in understanding heat generation of the connector at various currents. When a defined failure is reached, the test ends. The highest current level achieved is usually listed as the current rating.

The temperature rise curve, and therefore the current rating, will change when certain key factors are varied. These are:

- Where is the temperature sensing probe placed? If placed on the contact in the mating area (the hottest spot), the results will be quite different than if placed on the outside of the connector body.
- Are the contacts being tested and rated in free air or are they contained within the connector housing? Contacts will obviously be cooler in free air.
- Are all of the contacts in the connector under load? If only part of the contacts are under load, the temperature rise could be less.
- What is the defined failure? Does the test end when the temperature rise reaches 30°C, 40°C, or some other number? Does it end when the temperature rise plus ambient temperature equal the operating limit of the connector housing? The current rating will be fixed by the defined failure point.
- How were the test samples prepared? Were the samples energized through a printed circuit board? How many layers? How large were the traces? What was the weight of the copper? Were the samples energized through wire? What size was the wire? How long was the wire? Was the sample tested in static or forced air conditions? All of these factors can affect cooling characteristics.

Clearly, a current rating value alone is not enough, and must be viewed in the context of the test used to develop the rating. When the test method is understood, evaluating and comparing power connectors for specific applications becomes much less of a mystery.

## THE PCS SERIES utilizes Positronic LARGE SURFACE AREA CONTACT MATING SYSTEM

- Separates mechanical and electrical functions for superior performance
- Low contact resistance provides minimized voltage drop across the contact
- True closed entry design prevents damage to female contacts and will not allow misaligned or bent contacts to enter
- Precision machined from solid copper alloy
- Stable insertion and withdrawal forces throughout repeated mating cycles

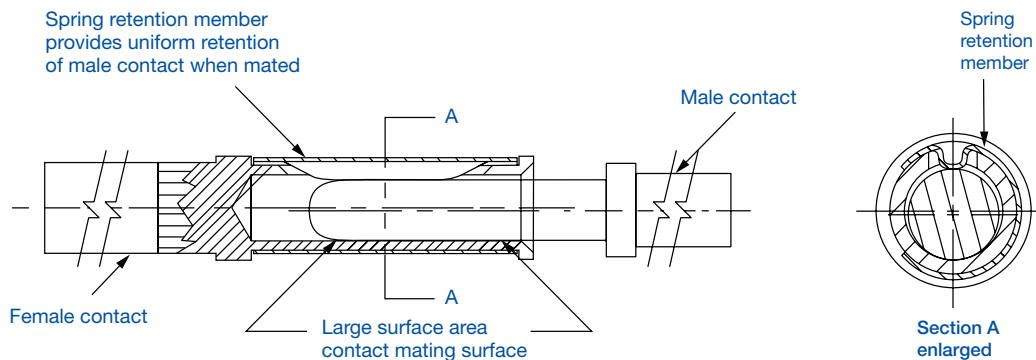

### WHY IS THE L.S.A. SYSTEM SUPERIOR?

The primary function of connector contact is electrical conductivity. Also, a mechanical function is required to provide normal force between male and female contacts.

In order to provide for proper mechanical characteristics, material that has good memory or “elasticity” must be chosen. This will ensure contact normal force in a coupled condition and allow for repeated coupling and uncoupling.

Unfortunately, many materials that have good memory characteristics have low electrical conductivity. For instance, beryllium copper is a good choice for mechanical function; however, some beryllium copper alloys are poor conductors and have relatively low conductivity rates.

**The conductivity path of many contact designs goes directly through materials that have been chosen based on mechanical need.** If these materials have a low conductivity rating, increased contact resistance will result.

**Positronic Large Surface Area Contact System separates the mechanical and electrical functions.** A spring retention member provides normal forces, while the electrical conductivity path is through highly conductive contact material. See above detail.



# BI-SPRING POWER PRESS-IN TERMINATIONS

**The Next Evolution In Compliant Technology. Fully Compliant, Fully Reliable.**

Reliable, solderless connections from connectors to backplanes started with solid press-in technology. Although these are still used today, concerns about board damage led to the use of compliant press-in technology. This technology allows the connection to be made through compliance of the contact termination along with printed circuit board hole deformation. Although risk of damaged printed circuit boards and backplanes is lessened, damage can still occur due to relatively high

insertion and extraction forces. The next step in press-in technology is a highly reliable connection between the contact termination and backplane that is accomplished with reduced insertion and extraction forces. This eliminates risk of printed circuit board and backplane damage. This technology exists today with Positronic Bi-Spring Power Press-in termination.

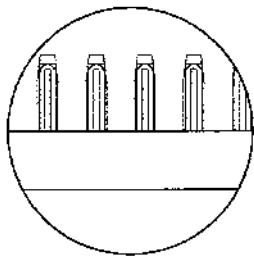

on and extraction forces of size 16 contacts are 22N [5 lbs.] per contact produce stresses in printed circuit boards and backplanes that can occur with higher forces. These stresses can cause board warpage and hole damage.

is utilizing Bi-Spring terminations use mounting screws to secure the connector to the board or backplane. Stresses that occur during coupling, uncoupling or shock and vibration are not transferred to the printed circuit boards or backplanes through the press-in connection. The integrity of the connector to board interface is maintained; this is particularly important in power applications. Figure GR1217 details a preference for mounting hardware when using press-in terminations.

## Bi-Spring Power Press-in Compliant Terminations

- Size 16 Bi-Spring terminations are designed to meet the performance requirements and hole diameters as listed in the internationally recognized specification IEC 60352-5.
- Lower insertion and extraction forces eliminate the need for expensive pressing equipment.

## COMPLIANT TERMINATION PRESS-IN CONNECTOR

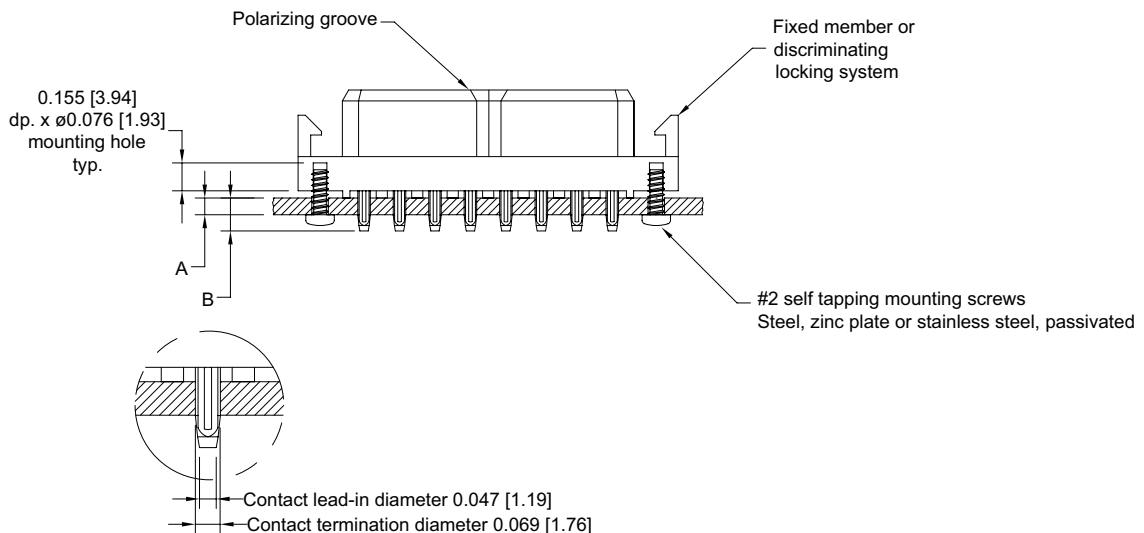

The design of Power Connection Systems Series connectors allows for the development of application specific contact arrangements in a timely manner and at a reasonable price. Thirteen connector housing sizes exist that may accommodate size 20, size 16, size 12, or size 8 contacts (see the Power Connection Systems catalog for connector housing dimensions). After reviewing the dimensions and the following basic information, contact Technical Sales with your current, voltage, and safety requirements. We look forward to working with you to develop a connector for your specific needs.

**BASIC CONNECTOR DIMENSIONS**

**Male Connector Dimensions**

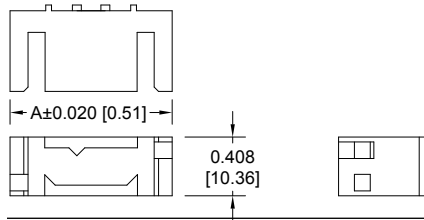

PART NUMBER	A
PLA03**00A1 PLAH03**00A1	1.126 [28.60]
PLA04**00A1 PLAH04**00A1	1.324 [33.63]
PLA06**00A1 PLAH06**00A1	1.718 [43.64]
PLA08**00A1 PLAH08**00A1	2.112 [53.64]

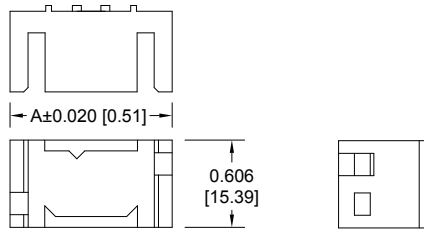

PART NUMBER	A
PLB06**00A1 PLBH06**00A1	1.126 [28.60]
PLB08**00A1 PLBH08**00A1	1.324 [33.63]
PLB12**00A1 PLBH12**00A1	1.718 [43.64]
PLB16**00A1 PLBH16**00A1	2.112 [53.64]
PLB20**00A1 PLBH20**00A1	2.506 [63.65]

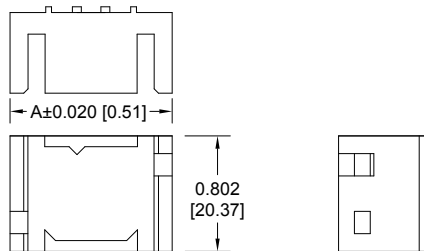

PART NUMBER	A
PLC09**00A1 PLCH09**00A1	1.126 [28.60]
PLC12**00A1 PLCH12**00A1	1.324 [33.63]
PLC18**00A1 PLCH18**00A1	1.718 [43.64]
PLC24**00A1 PLCH24**00A1	2.112 [53.64]
PLC30**00A1 PLCH30**00A1	2.506 [63.65]

**Female Connector Dimensions**

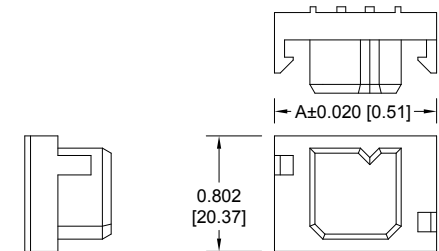
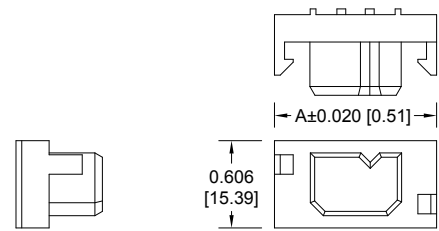
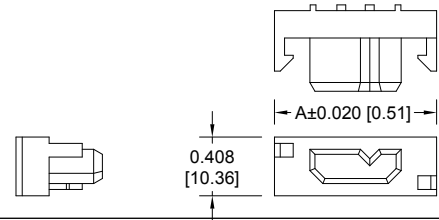

**Four Contact Sizes to Choose From**

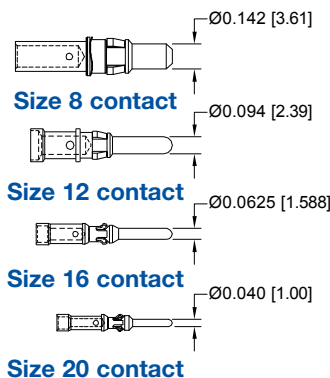

**Many Termination Types Can Be Supplied**

- Straight Solder or Press-in
- Right Angle (90°) Solder
- Crimp Removable
- Removable Solder Cup

**Popular Options**

- Sequential Mating
- Selective Loading

**Contact sizes and termination types may be mixed within a single connector.**



## TECHNICAL CHARACTERISTICS

### MATERIALS AND FINISHES:

<b>Insulator:</b>	Glass-filled polyester, UL 94V-0. Contact technical sales for availability of high temperature insulator material.
<b>Contacts:</b>	Precision machined copper alloy with gold flash over nickel, or 0.000030 inch [0.76µ] gold over nickel, or 0.000050 [1.27µ] gold over nickel. Solder coated terminations optional.
<b>Mounting Clip:</b>	Beryllium copper with nickel plate.
<b>Hood:</b>	Glass filled polyester, UL 94V-0.
<b>Mounting Bracket:</b>	Brass with tin plate.
<b>Push-on Fastener:</b>	Spring tempered copper alloy, tin plate

### ELECTRICAL CHARACTERISTICS:

#### CONTACT CURRENT RATING:

<b>Standard Contact Material:</b>	See page 9 for detail information.
<b>High Conductivity Contact Material:</b>	See page 9 for detail information.

#### INITIAL CONTACT RESISTANCE:

<b>Standard Contact Material:</b>	0.0016 ohms max. per IEC 60512-2, test 2b.
<b>High Conductivity Contact Material:</b>	0.0007 ohms max. per IEC 60512-2, test 2b.
<b>Insulation Resistance:</b>	5 G ohms per IEC 60512-2, test 3a, method A.
<b>Voltage Proof:</b>	2000 V rms per IEC 60512-2, test 4a, method C.
<b>Creepage Distance:</b>	0.157 inch [4 mm] minimum.
<b>Clearance Distance:</b>	0.125 inch [3.2 mm] minimum.
<b>Working Voltage:</b>	Designed to meet UL 600 VAC and CSA 600 VAC.
<b>Working Temperature:</b>	-55°C to +125°C Contact technical sales for availability of high temperature insulator material.

### ELECTRICAL CHARACTERISTICS OF COMPLIANT PRESS-IN CONNECTION TO PLATED-THROUGH-HOLE OF PRINTED BOARD:

	0.064 inch [1.63mm] diameter hole of a 0.125 inch [3.2mm] thick printed board
<b>Initial Contact Resistance of Connection:</b>	Less than 1.0 milliohms per IEC 60512-2, test 2a.
<b>Change in Contact Resistance of Connection After Mechanical, Electrical or Climactic Conditioning:</b>	Less than 0.5 milliohms increase per IEC 60512-2, test 2a.
<b>Gas Tight Connections Test:</b>	Less than 0.2 milliohms increase in contact resistance after 1 hour per EIA 364, TP36, Method One.

### SHIELDED CONTACT TECHNICAL CHARACTERISTICS:

See page 47.

### MECHANICAL CHARACTERISTICS:

<b>Removable Contacts:</b>	Insert contact to rear face of insulator, release from front face of insulator. Size 16, 0.0625 inch [1.588 mm] diameter male contact. Female contact "closed entry" design for highest reliability.
<b>Removable Contact Retention in Insulator:</b>	15 lbs. [67N] per IEC 60512-8, test 15a.
<b>Fixed Contacts:</b>	Solder cup and printed board terminations. Size 16, 0.0625 inch [1.588 mm] diameter male contact. Female contact has "closed entry" design for highest reliability.
<b>Fixed Contact Retention in Insulator:</b>	6 lbs. [26N].
<b>Resistance to Solder Iron Heat:</b>	500°F [260°C] for 10 seconds duration per IEC 60512-6, test 12e, 25 watt soldering iron.
<b>Contact Terminations:</b>	Crimp or solder removable contacts from wire sizes 12 AWG [4.0 mm <sup>2</sup> ] through 24 AWG [0.25 mm <sup>2</sup> ]. Straight and Right Angle (90°) solder printed board mount, 0.0625 inch [1.588 mm] tail diameter. Compliant termination press-in. Fixed contact solder cup termination, 18 AWG [1.0 mm <sup>2</sup> ] maximum.
<b>Contact Insertion and Withdrawal Forces:</b>	8 oz. [2.2N] nominal per contact.
<b>Connection Systems:</b>	Connector provides cable to cable, cable to printed board, cable to panel mount and printed board to printed board application.
<b>Sequential Mating System:</b>	Cable and printed board mount connectors. Male contacts provide as many as three mating lengths.
<b>Locking System:</b>	Insulators provide locking between cable to cable, cable to printed board and cable to panel mount applications.
<b>Polarizations:</b>	Provided in insulator design. Further polarization in cable connectors can be provided by mixing male contacts in female insulators and female contacts in male insulators.
<b>Mounting to Printed Board:</b>	Rapid installation push-on fasteners. Self-tapping screws for compliant connectors.
<b>Mechanical Operations:</b>	500 operations per IEC 60512-5.

### MECHANICAL CHARACTERISTICS OF COMPLIANT PRESS-IN CONNECTORS:

<b>Press-in Contact Bi-Spring Construction, Compliant Termination:</b>	0.0695 inch [1.77mm] diameter with 0.050 inch [1.27mm] lead-in diameter. Offered with two termination lengths.
<b>Contact Retention in Insulator and 0.125 inch [3.2mm] thick printed board:</b>	5 lbs. [22N] minimum combined retention forces per MIL-STD-2166, Type III compliant contact classification, after third repair- replacement of contact in insulator and plated-through-hole, 0.064 inch [1.63mm] diameter in a 0.125 inch [3.2mm] thick printed board.
<b>Vibration:</b>	No electrical discontinuity of 1µ second or greater when tested per MIL-STD-1344, Method 2005, Test conditioning.
<b>Initial Press-In Force of Individual Contact into Plated-Through-Hole:</b>	10 lbs. [44N] average when pushed into a 0.064 inch [1.63mm] Ø hole in a 0.125 inch [3.2mm] thick printed board.
<b>Initial Push-Out Force of Individual Contact into Plated-Through-Hole:</b>	8.5 lbs. [38N] average when pushed out of an 0.064 inch [1.63mm] Ø hole in a 0.125 inch [3.2mm] thick printed board.

CUL Recognized\*

File # E49351

\*Note: CUL recognizes all sizes, except PLB20, consult Technical Sales for status.

TEMPERATURE RISE CURVE

**STANDARD CONTACT MATERIALS**  
CONNECTORS WITH PL\* PREFIX

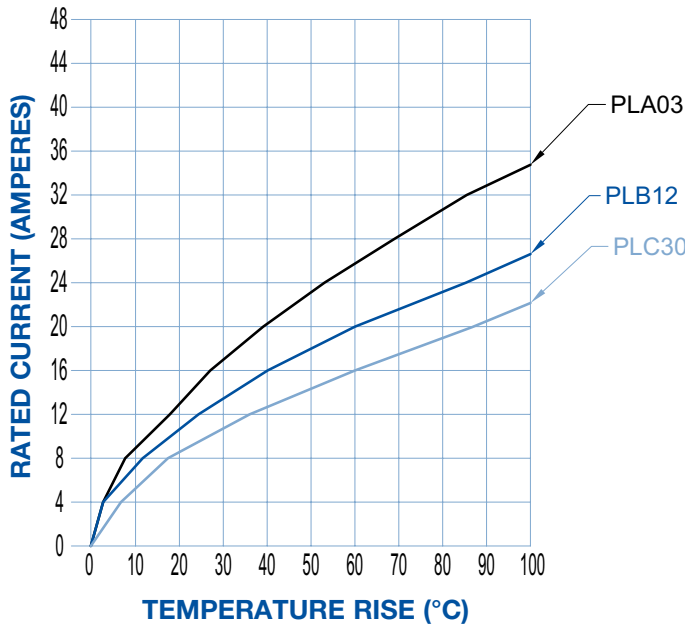

**HIGH CONDUCTIVITY CONTACT MATERIALS**  
CONNECTORS WITH PL\*H PREFIX  
OR "S" SUFFIX ON CRIMP CONTACTS

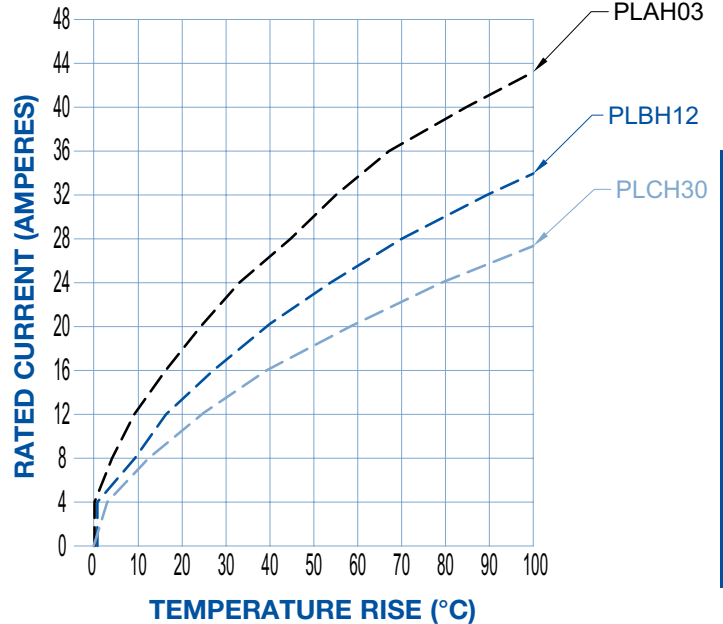

**TEST DETAIL:** Each curve was developed using individual connector bodies fully loaded with contacts. All power contacts energized through 12 awg wire. Temperature rise was measured in the contact mating area. Test was conducted with connectors in static air. Terminations of test connectors were straight compliant press-in to right angle (90°) solder. See page 4 for more information.

CONTACT CURRENT RATINGS			
CONNECTOR VARIANT	STANDARD CONTACTS	CONNECTOR VARIANT	HIGH CONDUCTIVITY CONTACTS
PLA03	32 amperes	PLAH03	42 amperes
PLB12	25 amperes	PLBH12	32 amperes
PLC30	18 amperes	PLCH30	24 amperes

Temperature rise curves and contact current ratings were developed for the specific connector variants shown when tested in accordance with UL1977.

This information is provided so that the user can make comparisons between various connector sizes and contact materials.



## MATING DIMENSIONS (FULLY MATED)

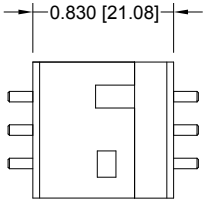

**Straight Board Mount Male  
to Straight Board Mount  
Female**

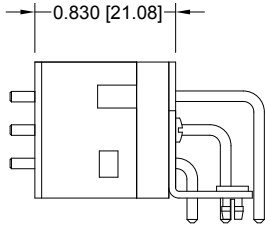

**Straight Board Mount Male  
to Right Angle (90°) Board  
Mount Female**

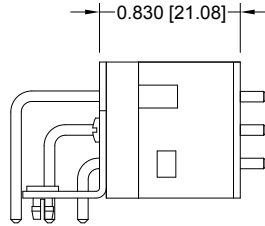

**Right Angle (90°) Board  
Mount Male to Straight  
Board Mount Female**

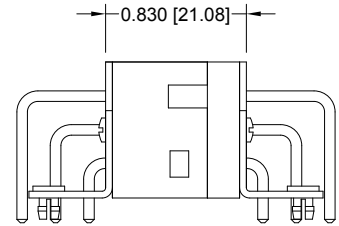

**Right Angle (90°) Board  
Mount Male to Right Angle  
(90°) Board Mount Female**

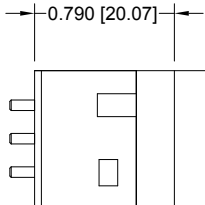

**Straight Board Mount Male  
to Panel Mount  
Female**



**Panel Mount Male  
to Straight Board  
Mount Female**

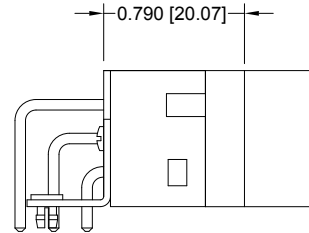

**Right Angle (90°) Board  
Mount Male to Panel  
Board Mount Female**

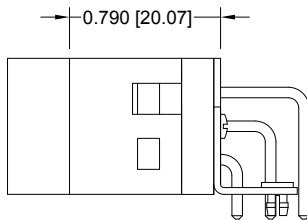

**Panel Mount Male  
to Right Angle (90°) Board  
Mount Female**

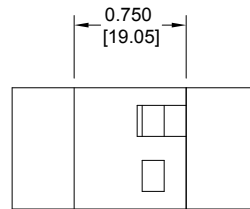

**Panel Mount Male  
to Panel Mount  
Female**

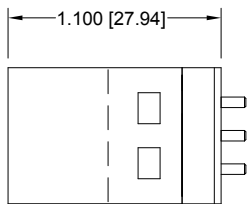

**Cable Mount Male  
to Straight Board  
Mount Female**

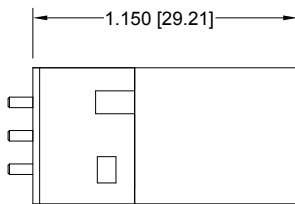

**Straight Board Mount  
Male to Cable  
Mount Female**

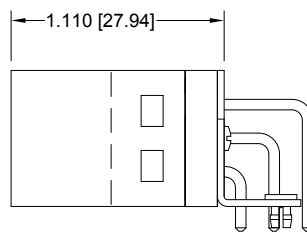

**Cable Mount Male  
to Right Angle (90°)  
Board Mount Female**

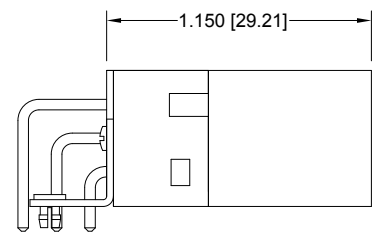

**Right Angle (90°) Board Mount  
Male to Cable Mount  
Female**

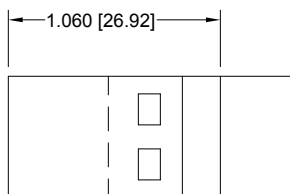

**Cable Mount Male  
to  
Panel Mount Female**

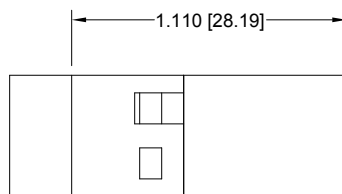

**Panel Mount Male  
to Cable Mount  
Female**

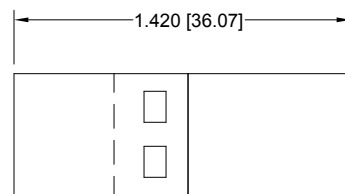

**Cable Mount Male  
to  
Cable Mount Female**



## PLA STRAIGHT PRINTED BOARD MOUNT CONNECTORS CODE 3, 0.146 [3.71] CONTACT EXTENSION

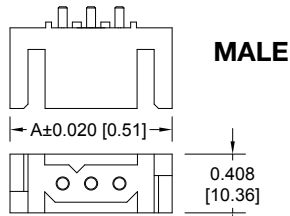

Typical part number:  
PLA03M300A1  
PLAH03M300A1

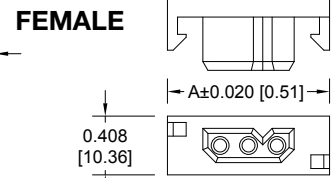
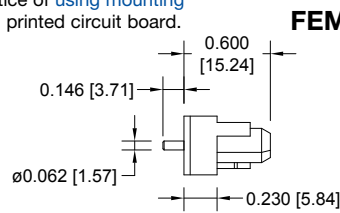
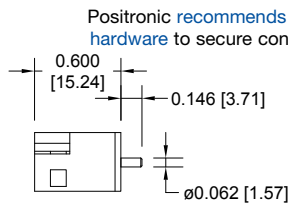

Typical part number:  
PLA03F300A1  
PLAH03F300A1

PART NUMBER	A	PART NUMBER	A
PLA03*300A1	1.126 [28.60]	PLA06*300A1	1.718 [43.64]
PLAH03*300A1		PLAH06*300A1	
PLA04*300A1	1.324 [33.63]	PLA08*300A1	2.112 [53.64]
PLAH04*300A1		PLAH08*300A1	

\*Asterisk determines gender of connector, M for male, F for female.

Plating- See ordering information for contact plating options.

For connection systems 1, 4 and 6.

**NOTE:** MOUNTING SCREWS CAN BE SUPPLIED WITH CONNECTORS USING STEP 5 IN ORDERING INFORMATION ON PAGE 26. MOUNTING SCREWS CAN ALSO BE ORDERED SEPARATELY BY PART NUMBER. SEE PAGE 59.

## PLB STRAIGHT PRINTED BOARD MOUNT CONNECTORS CODE 3, 0.146 [3.71] CONTACT EXTENSION

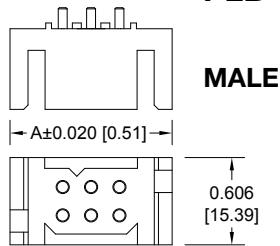

Typical part number:  
PLB06M300A1  
PLBH06M300A1

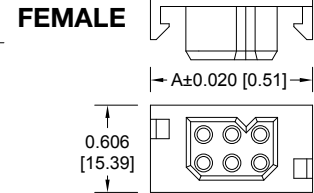
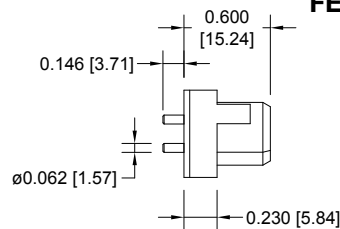
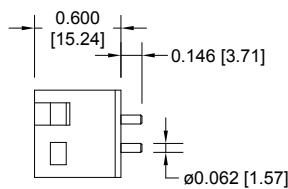

Typical part number:  
PLB06F300A1  
PLAH06F300A1

PART NUMBER	A	PART NUMBER	A
PLB06*300A1	1.126 [28.60]	PLB16*300A1	2.112 [53.64]
PLBH06*300A1		PLBH16*300A1	
PLB08*300A1	1.324 [33.63]	PLB20*300A1	2.506 [63.65]
PLBH08*300A1		PLBH20*300A1	
PLB12*300A1	1.718 [43.64]		
PLBH12*300A1			

\*Asterisk determines gender of connector, M for male, F for female.

Plating- See ordering information for contact plating options.

For connection systems 1, 4 and 6.

**NOTE:** MOUNTING SCREWS CAN BE SUPPLIED WITH CONNECTORS USING STEP 5 IN ORDERING INFORMATION ON PAGE 26. MOUNTING SCREWS CAN ALSO BE ORDERED SEPARATELY BY PART NUMBER. SEE PAGE 59.

## PLC STRAIGHT PRINTED BOARD MOUNT CONNECTORS CODE 3, 0.146 [3.71] CONTACT EXTENSION

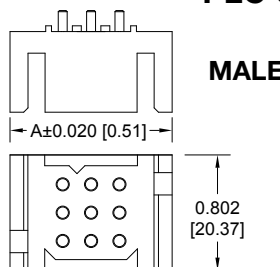

Typical part number:  
PLC09M300A1  
PLCH09M300A1

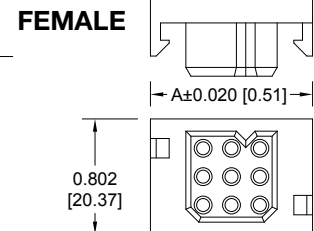
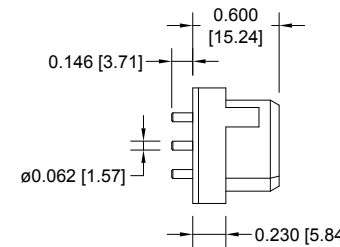
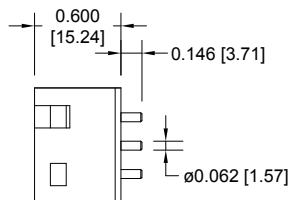

Typical part number:  
PLC09F300A1  
PLCH09F300A1

PART NUMBER	A	PART NUMBER	A
PLC09*300A1	1.126 [28.60]	PLC24*300A1	2.112 [53.64]
PLCH09*300A1		PLCH24*300A1	
PLC12*300A1	1.324 [33.63]	PLC30*300A1	2.506 [63.65]
PLCH12*300A1		PLCH30*300A1	
PLC18*300A1	1.718 [43.64]		
PLCH18*300A1			

\*Asterisk determines gender of connector, M for male, F for female.

Plating- See ordering information for contact plating options.

For connection systems 1, 4 and 6.

**NOTE:** MOUNTING SCREWS CAN BE SUPPLIED WITH CONNECTORS USING STEP 5 IN ORDERING INFORMATION ON PAGE 26. MOUNTING SCREWS CAN ALSO BE ORDERED SEPARATELY BY PART NUMBER. SEE PAGE 59.

DIMENSIONS ARE IN INCHES [MILLIMETERS]. ALL DIMENSIONS ARE SUBJECT TO CHANGE.



Positronic  
connectpositronic.com

# STRAIGHT SOLDER PRINTED BOARD CONNECTOR

Power  
Connection  
Systems

## PLA STRAIGHT PRINTED BOARD MOUNT CONNECTORS CODE 32, 0.377 [9.58] CONTACT EXTENSION

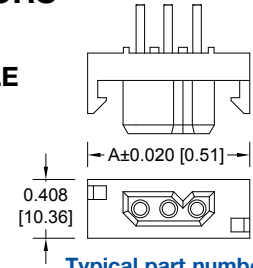
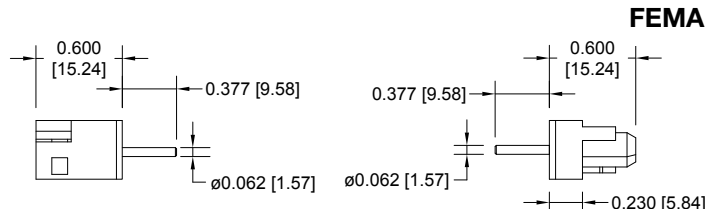
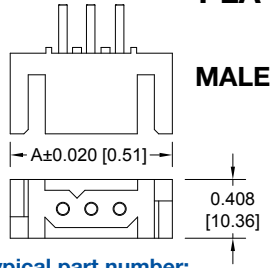

Typical part number:  
PLA03M3200A1  
PLAH03M3200A1

Typical part number:  
PLA03F3200A1  
PLAH03F3200A1

**NOTE:** MOUNTING SCREWS CAN BE SUPPLIED WITH CONNECTORS USING STEP 5 IN ORDERING INFORMATION ON PAGE 26. MOUNTING SCREWS CAN ALSO BE ORDERED SEPARATELY BY PART NUMBER. SEE PAGE 59.

PART NUMBER	A	PART NUMBER	A
PLA03*3200A1 PLAH03*3200A1	1.126 [28.60]	PLA06*3200A1 PLAH06*3200A1	1.718 [43.64]
PLA04*3200A1 PLAH04*3200A1	1.324 [33.63]	PLA08*3200A1 PLAH08*3200A1	2.112 [53.64]

\*Asterisk determines gender of connector, M for male, F for female.

Plating- See ordering information for contact plating options.

For connection systems 1, 3, 4 and 6.

## PLB STRAIGHT PRINTED BOARD MOUNT CONNECTORS CODE 32, 0.377 [9.58] CONTACT EXTENSION

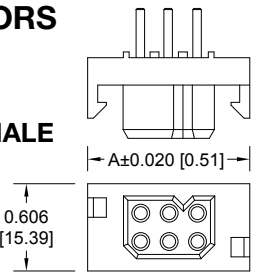
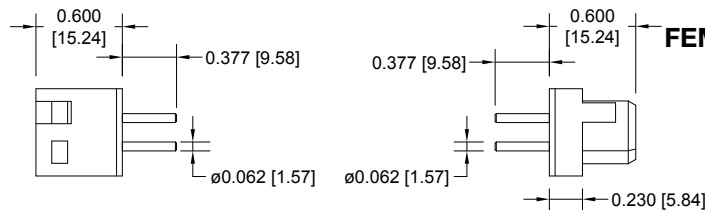
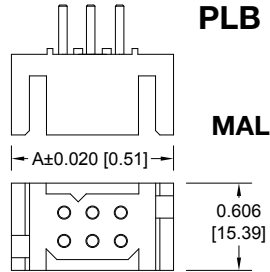

Typical part number:  
PLB06M3200A1  
PLBH06M3200A1

Typical part number:  
PLB06F3200A1  
PLBH06F3200A1

**NOTE:** MOUNTING SCREWS CAN BE SUPPLIED WITH CONNECTORS USING STEP 5 IN ORDERING INFORMATION ON PAGE 26. MOUNTING SCREWS CAN ALSO BE ORDERED SEPARATELY BY PART NUMBER. SEE PAGE 59.

PART NUMBER	A	PART NUMBER	A
PLB06*3200A1 PLBH06*3200A1	1.126 [28.60]	PLB16*3200A1 PLBH16*3200A1	2.112 [53.64]
PLB08*3200A1 PLBH08*3200A1	1.324 [33.63]	PLB20*3200A1 PLBH20*3200A1	2.506 [63.65]
PLB12*3200A1 PLBH12*3200A1	1.718 [43.64]		

\*Asterisk determines gender of connector, M for male, F for female.

Plating- See ordering information for contact plating options.

For connection systems 1, 3, 4 and 6.

## PLC STRAIGHT PRINTED BOARD MOUNT CONNECTORS CODE 32, 0.377 [9.58] CONTACT EXTENSION

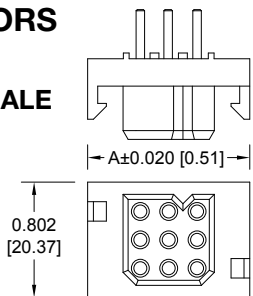
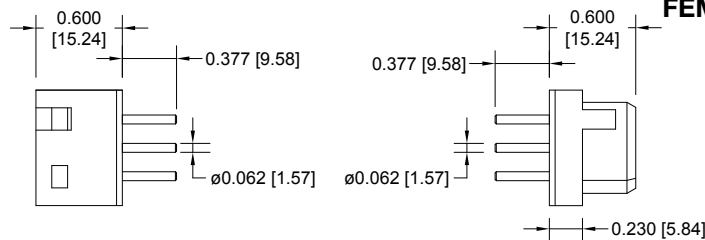
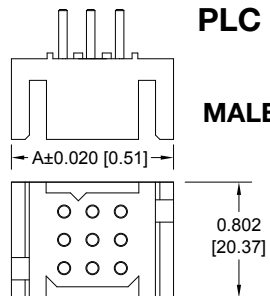

Typical part number:  
PLC09M3200A1  
PLCH09M3200A1

Typical part number:  
PLC09F3200A1  
PLCH09F3200A1

**NOTE:** MOUNTING SCREWS CAN BE SUPPLIED WITH CONNECTORS USING STEP 5 IN ORDERING INFORMATION ON PAGE 26. MOUNTING SCREWS CAN ALSO BE ORDERED SEPARATELY BY PART NUMBER. SEE PAGE 59.

PART NUMBER	A	PART NUMBER	A
PLC09*3200A1 PLCH09*3200A1	1.126 [28.60]	PLC24*3200A1 PLCH24*3200A1	2.112 [53.64]
PLC12*3200A1 PLCH12*3200A1	1.324 [33.63]	PLC30*3200A1 PLCH30*3200A1	2.506 [63.65]
PLC18*3200A1 PLCH18*3200A1	1.718 [43.64]		

\*Asterisk determines gender of connector, M for male, F for female.

Plating- See ordering information for contact plating options.

For connection systems 1, 3, 4 and 6.



PLA COMPLIANT PRESS-IN CONNECTORS  
CODE 92 OR CODE 93

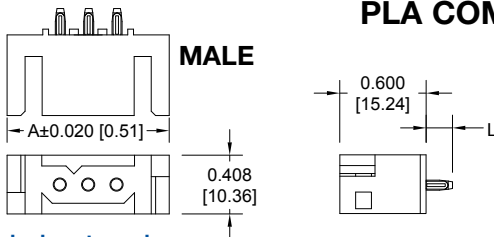

Typical part number:  
PLA03M93ST30A1  
PLAH03M93ST30A1

\*\*Asterisks determine gender of connector, M for male, F for female and contact code 92 or 93.

PART NUMBER	A
PLA03**00A1 PLAH03**00A1	1.126 [28.60]
PLA04**00A1 PLAH04**00A1	1.324 [33.63]
PLA06**00A1 PLAH06**00A1	1.718 [43.64]
PLA08**00A1 PLAH08**00A1	2.112 [53.64]

See page 56  
for Installation Tooling.

Plating- See ordering information for contact plating options.  
For connection systems 1, 4 and 6.

**NOTE:** Positronic recommends the practice of using mounting hardware to secure connector to printed circuit board. Mounting screws can be supplied with connectors using step 5 in ordering information on page 26. Mounting screws can also be ordered separately by part number. See page 59.

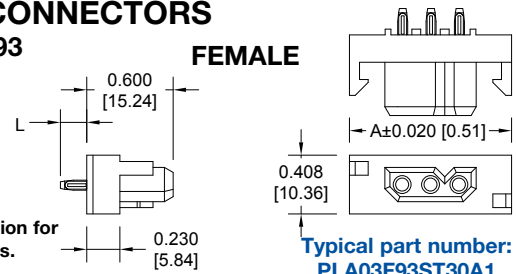

Typical part number:  
PLA03F93ST30A1  
PLAH03F93ST30A1

CONTACT CODE	L	PCB THICKNESS
92	0.183 [4.65]	0.093 [2.36]
93	0.218 [5.54]	0.125 [3.18]

PLB COMPLIANT PRESS-IN CONNECTORS  
CODE 92 OR CODE 93

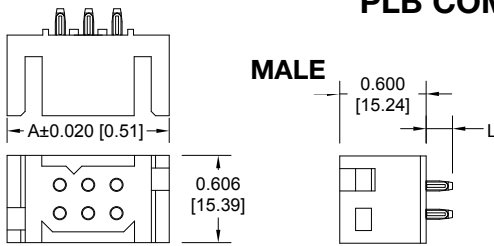

Typical part number:  
PLB06M93ST30A1  
PLBH06M93ST30A1

\*\*Asterisks determine gender of connector, M for male, F for female and contact code 92 or 93.

PART NUMBER	A
PLB06**00A1 PLBH06**00A1	1.126 [28.60]
PLB08**00A1 PLBH08**00A1	1.324 [33.63]
PLB12**00A1 PLBH12**00A1	1.718 [43.64]
PLB16**00A1 PLBH16**00A1	2.112 [53.64]
PLB20**00A1 PLBH20**00A1	2.506 [63.65]

See page 56  
for Installation Tooling.

Plating- See ordering information for contact plating options.  
For connection systems 1, 4 and 6.

**NOTE:** Positronic recommends the practice of using mounting hardware to secure connector to printed circuit board. Mounting screws can be supplied with connectors using step 5 in ordering information on page 26. Mounting screws can also be ordered separately by part number. See page 59.

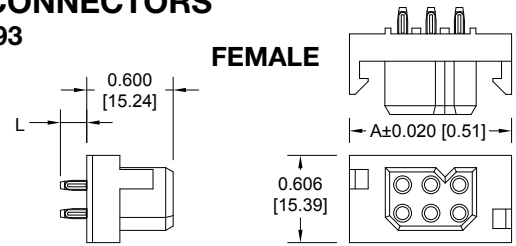

Typical part number:  
PLB06F93ST30A1  
PLBH06F93ST30A1

CONTACT CODE	L	PCB THICKNESS
92	0.183 [4.65]	0.093 [2.36]
93	0.218 [5.54]	0.125 [3.18]

PLC COMPLIANT PRESS-IN CONNECTORS  
CODE 92 OR CODE 93

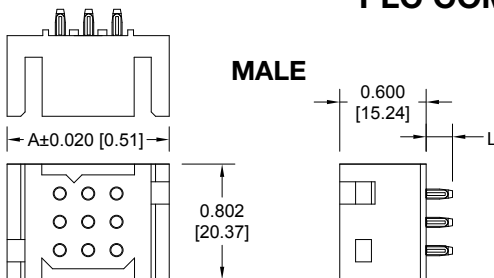

Typical part number:  
PLC09M93ST30A1  
PLCH09M93ST30A1

\*\*Asterisks determine gender of connector, M for male, F for female and contact code 92 or 93.

PART NUMBER	A
PLC09**00A1 PLCH09**00A1	1.126 [28.60]
PLC12**00A1 PLCH12**00A1	1.324 [33.63]
PLC18**00A1 PLCH18**00A1	1.718 [43.64]
PLC24**00A1 PLCH24**00A1	2.112 [53.64]
PLC30**00A1 PLCH30**00A1	2.506 [63.65]

See page 56  
for Installation Tooling.

Plating- See ordering information for contact plating options.  
For connection systems 1, 4 and 6.

**NOTE:** Positronic recommends the practice of using mounting hardware to secure connector to printed circuit board. Mounting screws can be supplied with connectors using step 5 in ordering information on page 26. Mounting screws can also be ordered separately by part number. See page 59.

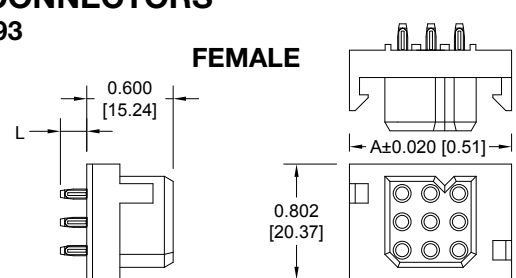

Typical part number:  
PLC09F93ST30A1  
PLCH09F93ST30A1

CONTACT CODE	L	PCB THICKNESS
92	0.183 [4.65]	0.093 [2.36]
93	0.218 [5.54]	0.125 [3.18]

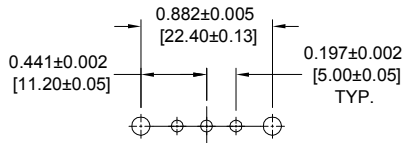

PLA 03

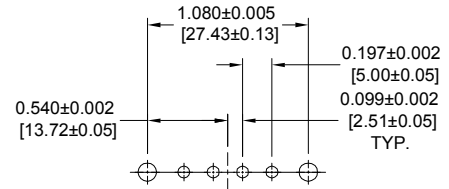

PLA 04

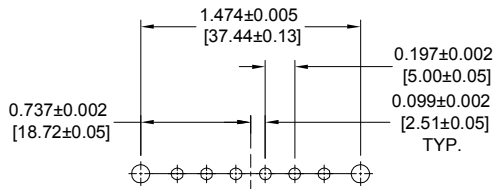

PLA 06

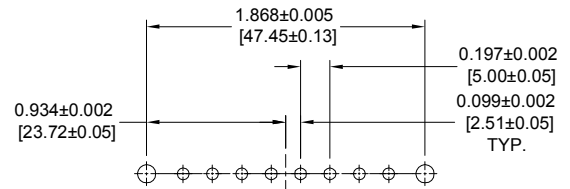

PLA 08

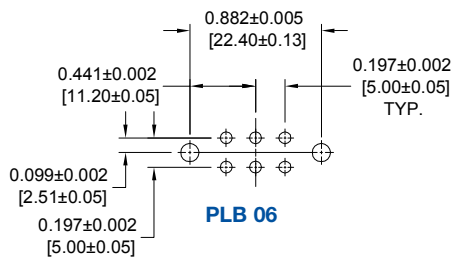

PLB 06

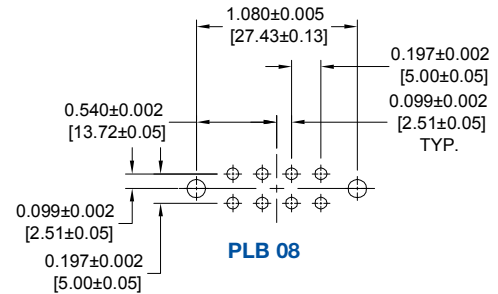

PLB 08

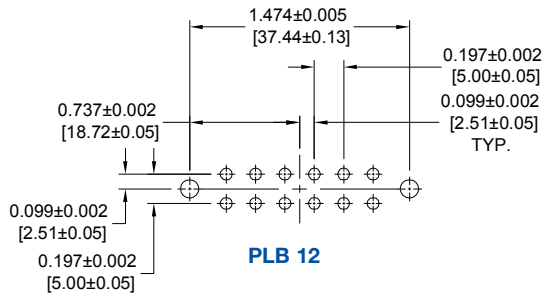

PLB 12

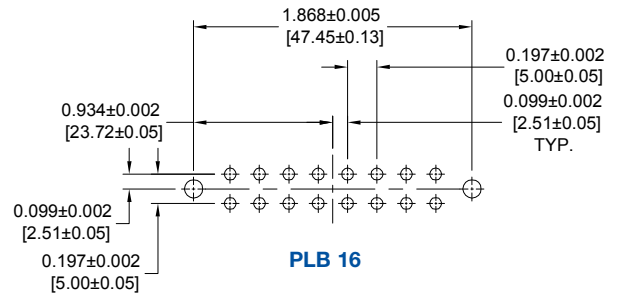

PLB 16

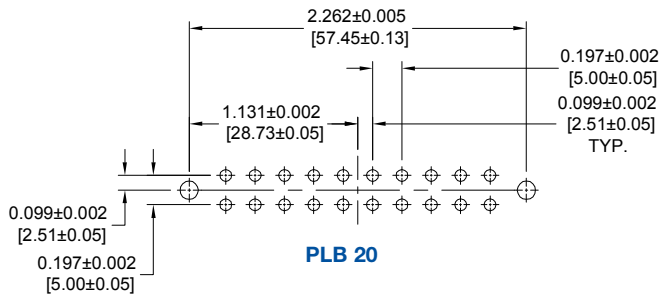

PLB 20

### SUGGESTED PRINTED BOARD HOLE SIZES:

Suggest 0.080 [2.03] Ø holes in printed board for solder contact termination positions.

Suggest 0.100 [2.54] Ø holes in printed board when mounting connectors with # 2 thread forming screws.

Suggest 0.123±0.003 [3.15±0.08] Ø holes in printed board when mounting connector with push-on fasteners.

**NOTE:** See page 57 for suggested printed board drill hole sizes, recommended plating and finished hole sizes for compliant contact termination positions.

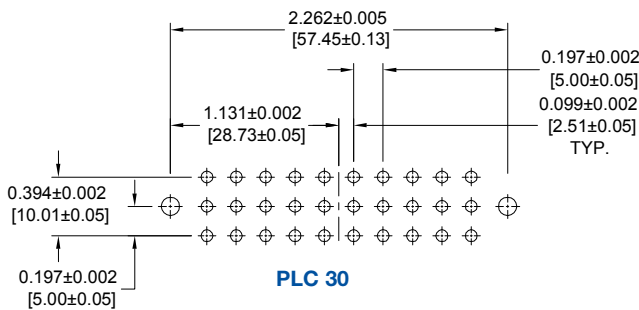
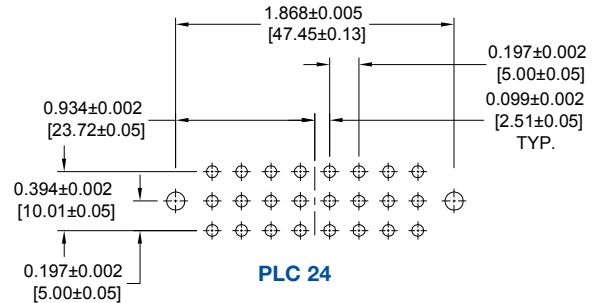
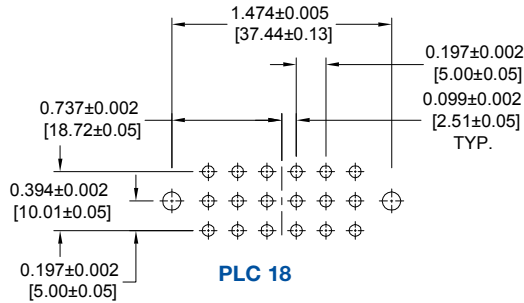
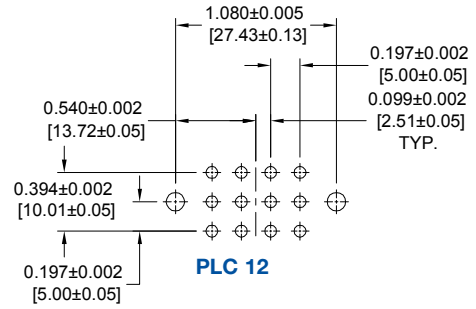
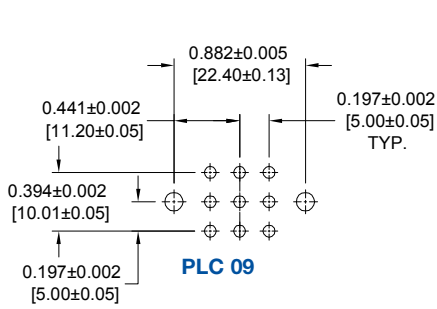

**SUGGESTED PRINTED BOARD HOLE SIZES:**

Suggest 0.080 [2.03] Ø holes in printed board for solder contact termination positions.

Suggest 0.100 [2.54] Ø holes in printed board when mounting connectors with # 2 thread forming screws.

Suggest 0.123±0.003 [3.15±0.08] Ø holes in printed board when mounting connector with push-on fasteners.

**NOTE:** See page 57 for suggested printed board drill hole sizes, recommended plating and finished hole sizes for compliant contact termination positions.

# Connectors Designed To Customer Specifications

Positronic's *PLA(H)*, *PLB(H)*, *PLC(H)* and *PLS(H)* series connectors can be modified to customers specifications.

**Examples:** select loading of contacts for cost savings or to gain creepage and clearance distances; longer printed circuit board terminations; customer specified hardware.

*Positronic can develop and tool new connector designs with reasonable price and delivery.*

**Contact Technical Sales with your particular requirements.**



### PLA RIGHT ANGLE (90°) PRINTED BOARD MOUNT CODE 4, 0.146 [3.71] CONTACT EXTENSION

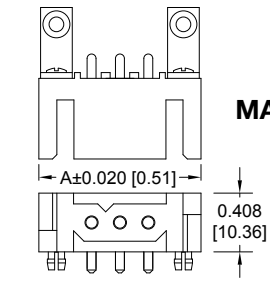

**MALE**

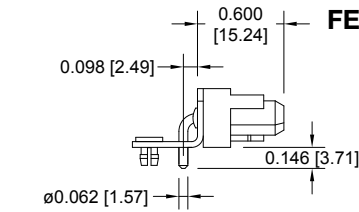
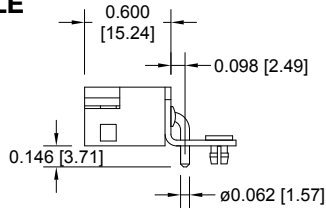

**FEMALE**

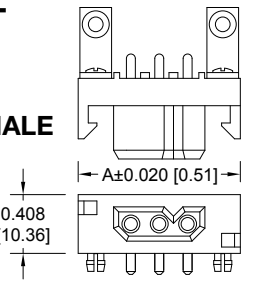

Typical part number:  
**PLA03M4BN0A1**  
**PLAH03M4BN0A1**

Typical part number:  
**PLA03F4BN0A1**  
**PLAH03F4BN0A1**

**NOTE:** MOUNTING SCREWS CAN BE ORDERED SEPARATELY BY PART NUMBER WHEN CHOOSING B3 BRACKETS. SEE PAGE 59.

PART NUMBER	A	PART NUMBER	A
PLA03*400A1	1.126 [28.60]	PLA06*400A1	1.718 [43.64]
PLA04*400A1	1.324 [33.63]	PLA08*400A1	2.112 [53.64]

\*Asterisk determines gender of connector, M for male, F for female.

Plating- See ordering information for contact plating options.

For connection systems 1, 2 and 5.

### PLB RIGHT ANGLE (90°) PRINTED BOARD MOUNT CODE 4, 0.146 [3.71] CONTACT EXTENSION

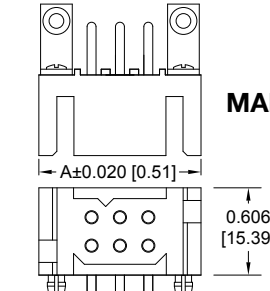

**MALE**

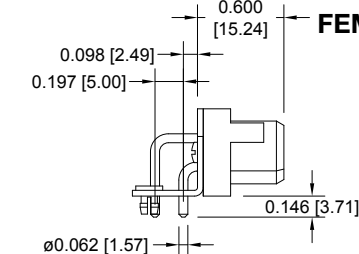
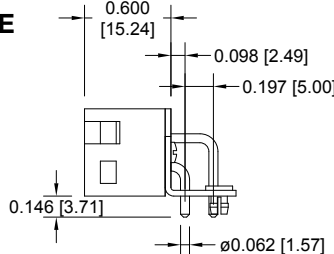

**FEMALE**

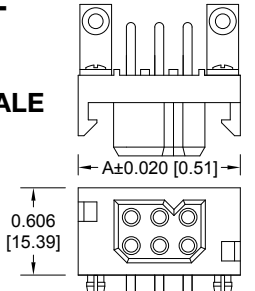

Typical part number:  
**PLB06M4BN0A1**  
**PLBH06MB4BN0A1**

Typical part number:  
**PLB06F4BN0A1**  
**PLBH06F4BN0A1**

**NOTE:** MOUNTING SCREWS CAN BE ORDERED SEPARATELY BY PART NUMBER WHEN CHOOSING B3 BRACKETS. SEE PAGE 59.

PART NUMBER	A	PART NUMBER	A
PLB06*400A1	1.126 [28.60]	PLB16*400A1	2.112 [53.64]
PLB08*400A1	1.324 [33.63]	PLB20*400A1	2.506 [63.65]
PLB12*400A1	1.718 [43.64]		

\*Asterisk determines gender of connector, M for male, F for female.

Plating- See ordering information for contact plating options.

For connection systems 1, 2 and 5.

### PLC RIGHT ANGLE (90°) PRINTED BOARD MOUNT CODE 4, 0.146 [3.71] CONTACT EXTENSION

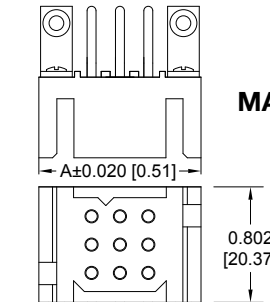

**MALE**

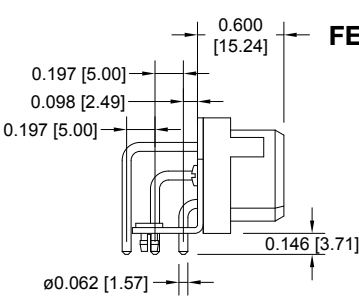
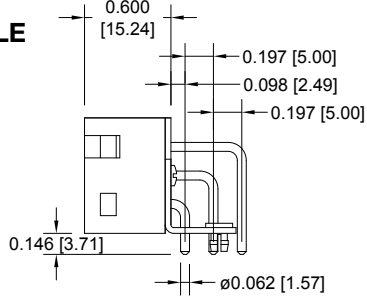

**FEMALE**

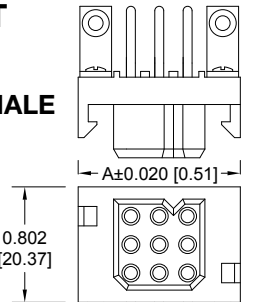

Typical part number:  
**PLC09M4BN0A1**  
**PLCH09M4BN0A1**

Typical part number:  
**PLC09F4BN0A1**  
**PLCH09F4BN0A1**

**NOTE:** MOUNTING SCREWS CAN BE ORDERED SEPARATELY BY PART NUMBER WHEN CHOOSING B3 BRACKETS. SEE PAGE 59.

PART NUMBER	A	PART NUMBER	A
PLC09*400A1	1.126 [28.60]	PLC24*400A1	2.112 [53.64]
PLC12*400A1	1.324 [33.63]	PLC30*400A1	2.506 [63.65]
PLC18*400A1	1.718 [43.64]		

\*Asterisk determines gender of connector, M for male, F for female.

Plating- See ordering information for contact plating options.

For connection systems 1, 2 and 5.

**PLA RIGHT ANGLE (90°) PRINTED BOARD MOUNT**  
CODE 42, 0.377 [9.58] CONTACT EXTENSION

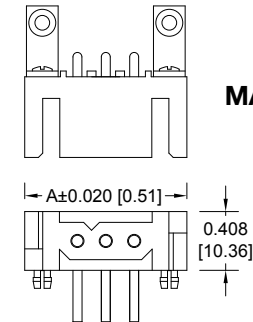

MALE

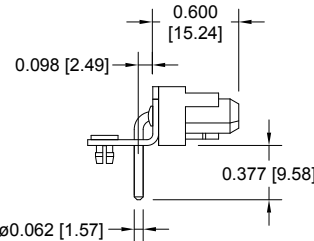
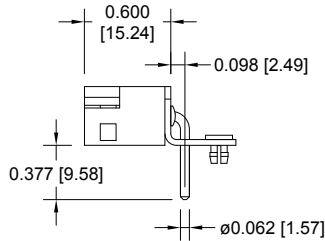

FEMALE

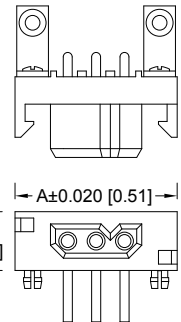

Typical part number:  
PLA03M42BN0A1  
PLAH03M42BN0A1

Typical part number:  
PLA03F42BN0A1  
PLAH03F42BN0A1

**NOTE:** MOUNTING SCREWS  
CAN BE ORDERED  
SEPARATELY BY PART  
NUMBER WHEN CHOOSING  
B3 BRACKETS. SEE PAGE 59.

PART NUMBER	A	PART NUMBER	A
PLA03*4200A1 PLAH03*4200A1	1.126 [28.60]	PLA06*4200A1 PLAH06*4200A1	1.718 [43.64]
PLA04*4200A1 PLAH04*4200A1	1.324 [33.63]	PLA08*4200A1 PLAH08*4200A1	2.112 [53.64]

Plating- See ordering information for  
contact plating options.  
For connection systems 1, 2, 3 and 5.

\*Asterisk determines gender of  
connector, M for male, F for female.

**PLB RIGHT ANGLE (90°) PRINTED BOARD MOUNT**  
CODE 42, 0.377 [9.58] CONTACT EXTENSION

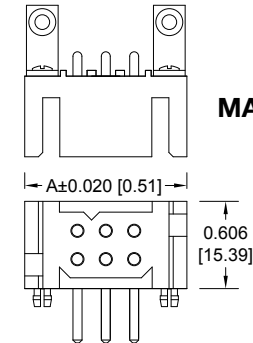

MALE

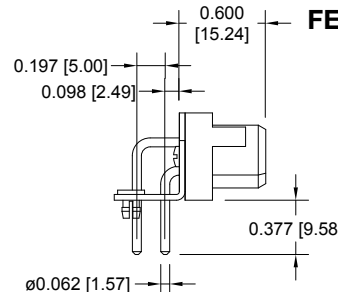
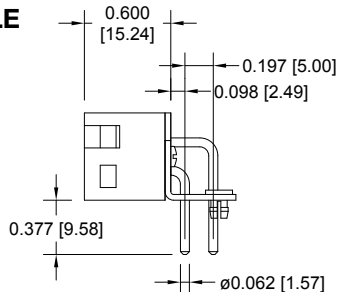

FEMALE

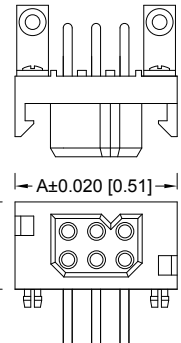

Typical part number:  
PLB06M42BN0A1  
PLBH06M42BN0A1

Typical part number:  
PLB06F42BN0A1  
PLBH06F42BN0A1

**NOTE:** MOUNTING SCREWS  
CAN BE ORDERED  
SEPARATELY BY PART  
NUMBER WHEN CHOOSING  
B3 BRACKETS. SEE PAGE 59.

PART NUMBER	A	PART NUMBER	A
PLB06*4200A1 PLBH06*4200A1	1.126 [28.60]	PLB16*4200A1 PLBH16*4200A1	2.112 [53.64]
PLB08*4200A1 PLBH08*4200A1	1.324 [33.63]	PLB20*4200A1 PLBH20*4200A1	2.506 [63.65]
PLB12*4200A1 PLBH12*4200A1	1.718 [43.64]		

Plating- See ordering information for  
contact plating options.  
For connection systems 1, 2, 3 and 5.

\*Asterisk determines gender of  
connector, M for male, F for female.

**PLC RIGHT ANGLE (90°) PRINTED BOARD MOUNT**  
CODE 42, 0.377 [9.58] CONTACT EXTENSION

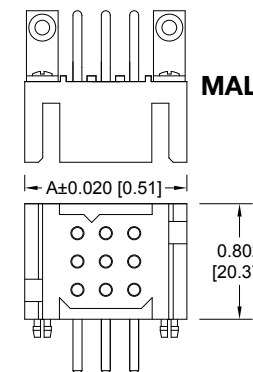

MALE

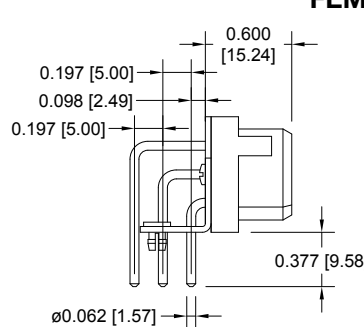
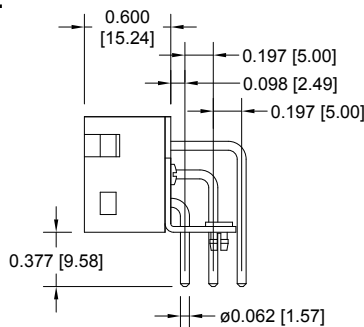

FEMALE

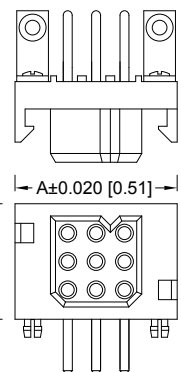

Typical part number:  
PLC09M42BN0A1  
PLCH09M42BN0A1

Typical part number:  
PLC09F42BN0A1  
PLCH09F42BN0A1

**NOTE:** MOUNTING SCREWS  
CAN BE ORDERED  
SEPARATELY BY PART  
NUMBER WHEN CHOOSING  
B3 BRACKETS. SEE PAGE 59.

PART NUMBER	A	PART NUMBER	A
PLC09*4200A1 PLCH09*4200A1	1.126 [28.60]	PLC24*4200A1 PLCH24*4200A1	2.112 [53.64]
PLC12*4200A1 PLCH12*4200A1	1.324 [33.63]	PLC30*4200A1 PLCH30*4200A1	2.506 [63.65]
PLC18*4200A1 PLCH18*4200A1	1.718 [43.64]		

Plating- See ordering information for  
contact plating options.  
For connection systems 1, 2, 3 and 5.

DIMENSIONS ARE IN INCHES [MILLIMETERS].  
ALL DIMENSIONS ARE SUBJECT TO CHANGE. 17

\*Asterisk determines gender of connector,  
M for male, F for female.



Positronic  
connectpositronic.com

# RIGHT ANGLE (90°) PRESS-IN CONNECTOR FOR USE WITH "FLAT ROCK" TOOLING

Power  
Connection  
Systems

## PLA RIGHT ANGLE (90°) PRESS-IN CONNECTOR

CODE 62 OR CODE 63

For connection systems 1, 2 and 5.

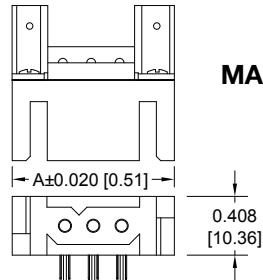

MALE

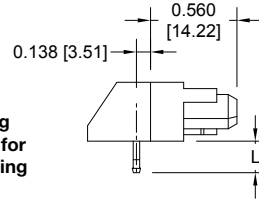
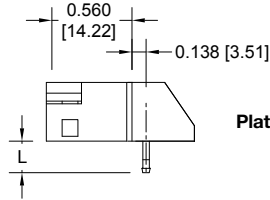

FEMALE

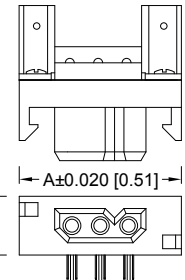

Typical part number:  
PLA03M63B30A1  
PLAH03M63B30A1

Typical part number:  
PLA03F63B30A1  
PLAH03F63B30A1

Plating- See ordering information for contact plating options.

PART NUMBER	A	PART NUMBER	A
PLA03**B30A1	1.126 [28.60]	PLA06**B30A1	1.718 [43.64]
PLAH03**B30A1		PLAH06**B30A1	
PLA04**B30A1	1.324 [33.63]	PLA08**B30A1	2.112 [53.64]
PLAH04**B30A1		PLAH08**B30A1	

\*\*Asterisk determines gender of connector, M for male, F for female, and contact code 62 or 63.

CONTACT CODE	L	PCB THICKNESS
62	0.183 [4.65]	0.093 [2.36]
63	0.219 [5.56]	0.125 [3.18]

NOTE: Positronic recommends the practice of using mounting hardware to secure connector to printed circuit board. Mounting screws are ordered separately by part number. See page 59.

## PLB RIGHT ANGLE (90°) PRESS-IN CONNECTOR

CODE 62 OR CODE 63

For connection systems 1, 2 and 5.

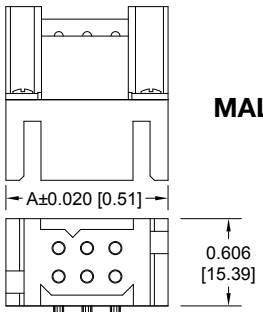

MALE

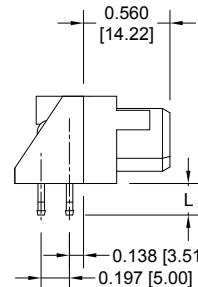
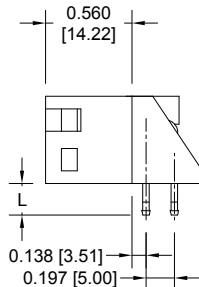

FEMALE

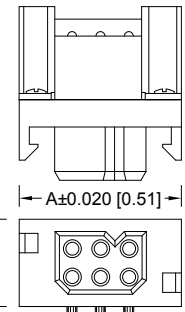

Typical part number:  
PLB06M63B30A1  
PLBH06M63B30A1

Typical part number:  
PLB06F63B30A1  
PLBH06F63B30A1

Plating- See ordering information for contact plating options.

PART NUMBER	A	PART NUMBER	A
PLB06**B30A1	1.126 [28.60]	PLB12**B30A1	1.718 [43.64]
PLBH06**B30A1		PLBH12**B30A1	
PLB08**B30A1	1.324 [33.63]	PLB16**B30A1	2.112 [53.64]
PLBH08**B30A1		PLBH16**B30A1	

\*\*Asterisk determines gender of connector, M for male, F for female, and contact code 62 or 63.

CONTACT CODE	L	PCB THICKNESS
62	0.183 [4.65]	0.093 [2.36]
63	0.219 [5.56]	0.125 [3.18]

NOTE: Positronic recommends the practice of using mounting hardware to secure connector to printed circuit board. Mounting screws are ordered separately by part number. See page 59.

## PLC RIGHT ANGLE (90°) PRESS-IN CONNECTOR

CODE 62 OR CODE 63

For connection systems 1, 2 and 5.

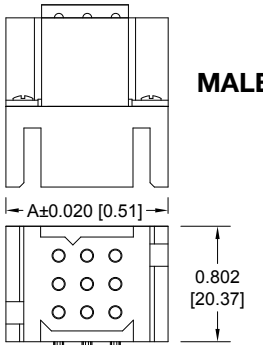

MALE

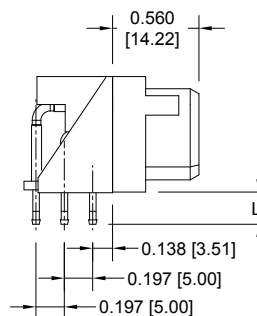
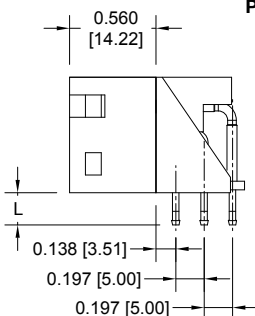

FEMALE

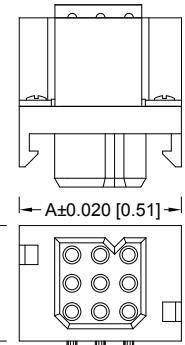

Typical part number:  
PLC09M63B30A1  
PLCH09M63B30A1

Typical part number:  
PLC09F63B30A1  
PLCH09F63B30A1

Plating- See ordering information for contact plating options.

PART NUMBER	A	PART NUMBER	A
PLC09**B30A1	1.126 [28.60]	PLC24**B30A1	2.112 [53.64]
PLCH09**B30A1		PLCH24**B30A1	
PLC12**B30A1	1.324 [33.63]	PLC30**B30A1	2.506 [63.65]
PLCH12**B30A1		PLCH30**B30A1	
PLC18**B30A1	1.718 [43.64]		
PLCH18**B30A1			

\*\*Asterisk determines gender of connector, M for male, F for female, and contact code 62 or 63.

CONTACT CODE	L	PCB THICKNESS
62	0.183 [4.65]	0.093 [2.36]
63	0.219 [5.56]	0.125 [3.18]

NOTE: Positronic recommends the practice of using mounting hardware to secure connector to printed circuit board. Mounting screws are ordered separately by part number. See page 59.



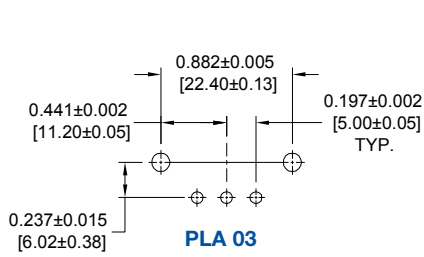

PLA 03

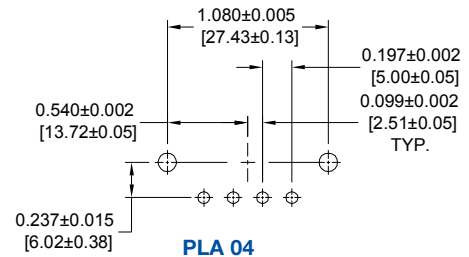

PLA 04

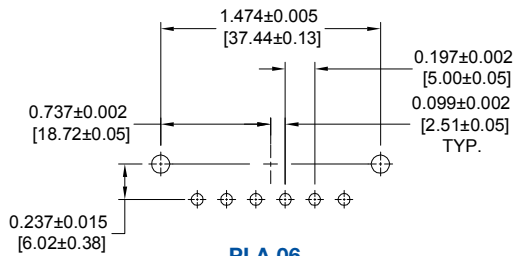

PLA 06

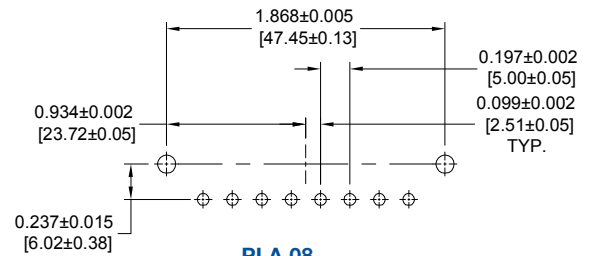

PLA 08

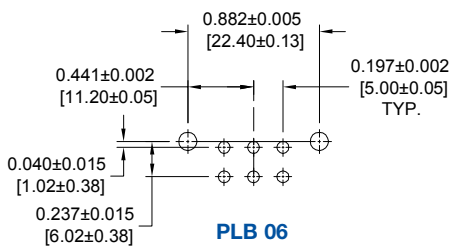

PLB 06

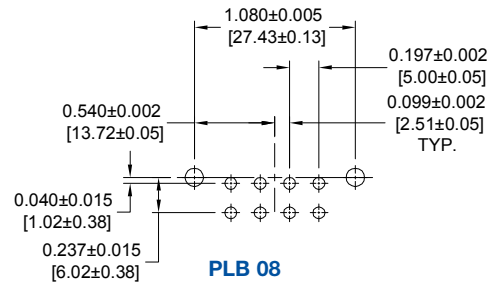

PLB 08

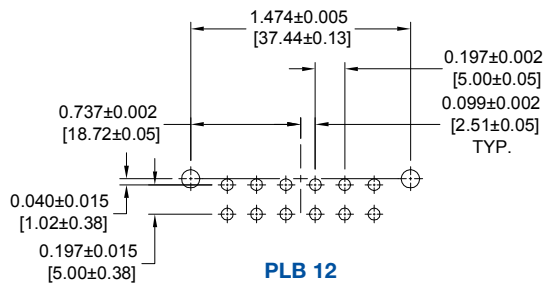

PLB 12

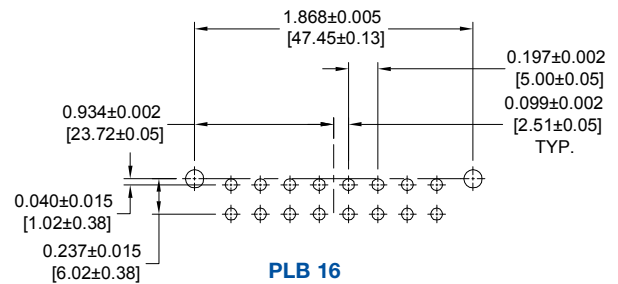

PLB 16

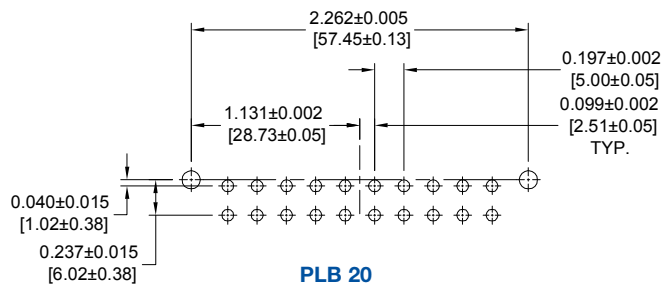

PLB 20

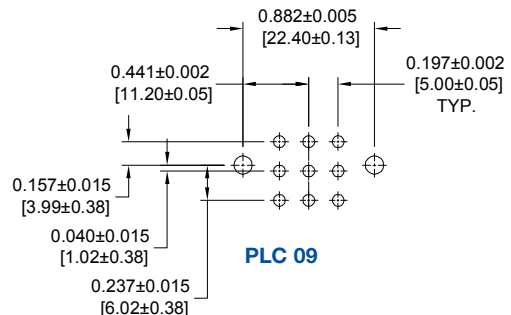

PLC 09

See page 20 for suggested printed board hole sizes.



Positronic  
connectpositronic.com

# RIGHT ANGLE (90°) PRINTED BOARD CONTACT HOLE PATTERN AND PANEL MOUNT CONNECTOR WITH SOLDER CUP CONTACTS

Power  
Connection  
Systems

PCS SERIES

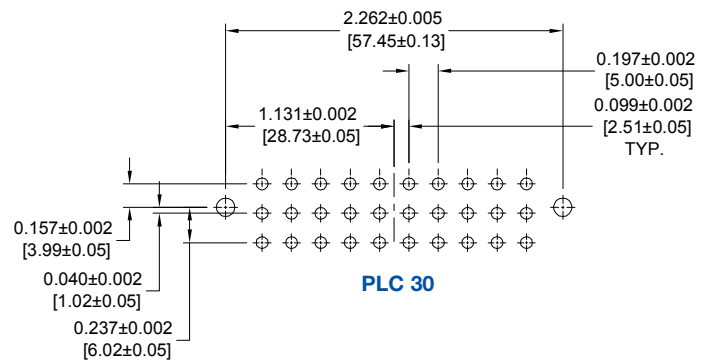
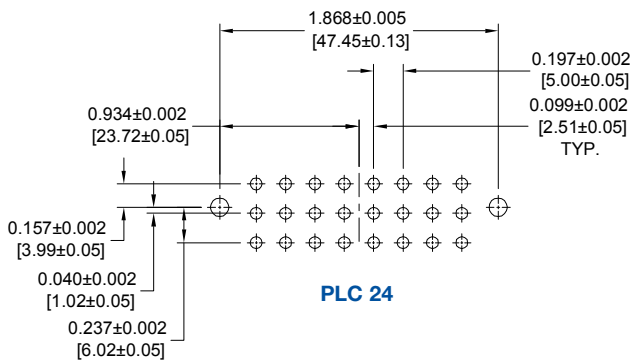
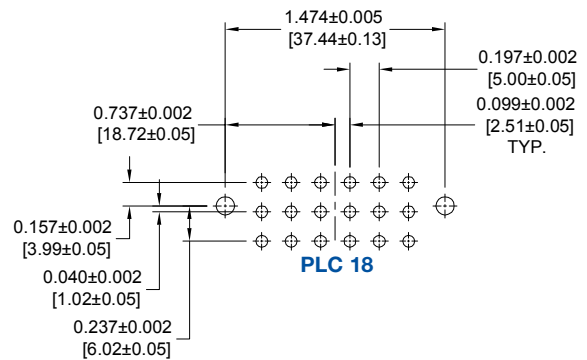
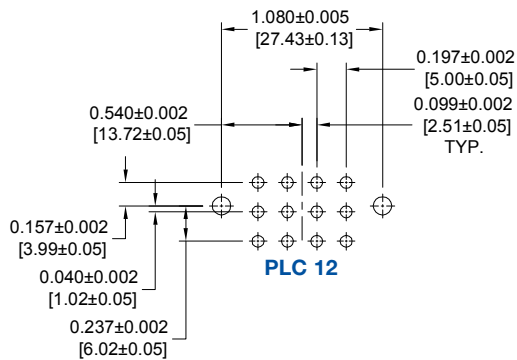

### SUGGESTED PRINTED BOARD HOLE SIZES:

Suggest 0.080 [2.03] Ø holes in printed board for solder contact termination positions.

Suggest 0.123±0.003 [3.15±0.08] Ø holes in printed board when mounting connector with push-on fasteners.

**NOTE:** See page 57 for suggested printed board drill hole sizes, recommended plating and finished hole sizes for compliant contact termination positions.

## PANEL MOUNT CONNECTORS WITH SOLDER CUP CONTACTS

CODE 2, 18 AWG [1.00mm<sup>2</sup>] MAX.

### MALE

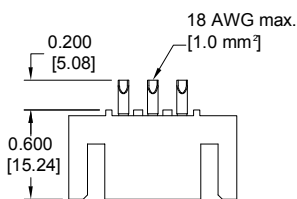

### FEMALE

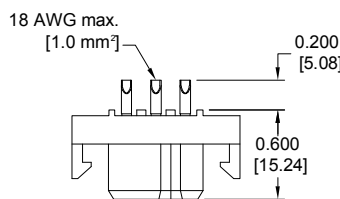

For connection system 8.

TYPICAL PART NUMBER:  
PLB06M200A1

TYPICAL PART NUMBER:  
PLB06F200A1

**NOTE:** MOUNTING SCREWS CAN BE SUPPLIED WITH CONNECTORS USING STEP 5 IN ORDERING INFORMATION ON PAGE 26. MOUNTING SCREWS CAN ALSO BE ORDERED SEPARATELY BY PART NUMBER. SEE PAGE 59.

CONNECTOR VARIANTS	A	B
PLA03	1.126 [28.60]	0.408 [10.36]
PLA04	1.324 [33.63]	0.408 [10.36]
PLA06	1.718 [43.64]	0.408 [10.36]
PLA08	2.112 [53.64]	0.408 [10.36]
PLB06	1.126 [28.60]	0.606 [15.39]
PLB08	1.324 [33.63]	0.606 [15.39]
PLB12	1.718 [43.64]	0.606 [15.39]
PLB16	2.112 [53.64]	0.606 [15.39]
PLB20	2.506 [63.65]	0.606 [15.39]
PLC09	1.126 [28.60]	0.802 [30.37]
PLC12	1.324 [33.63]	0.802 [30.37]
PLC18	1.718 [43.64]	0.802 [30.37]
PLC24	2.112 [53.64]	0.802 [30.37]
PLC30	2.506 [63.65]	0.802 [30.37]

## MALE INSULATOR DIMENSIONS FOR CABLE CONNECTORS WITH SIZE 16 REMOVABLE CONTACTS

CODE 0 OR CODE 7

CONTACTS ARE NOT SUPPLIED WITH CONNECTOR AND MUST BE ORDERED SEPARATELY

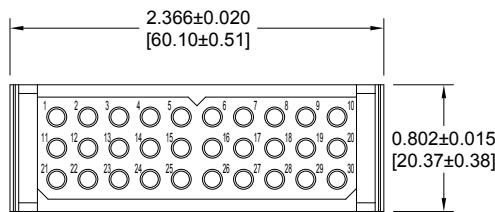
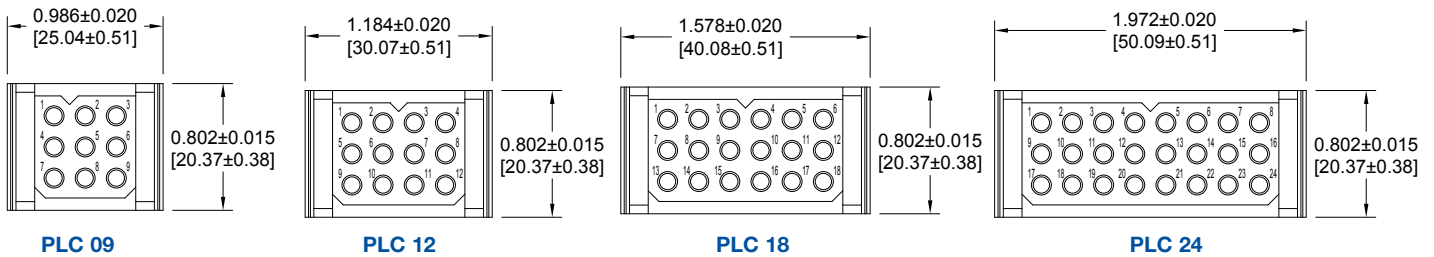
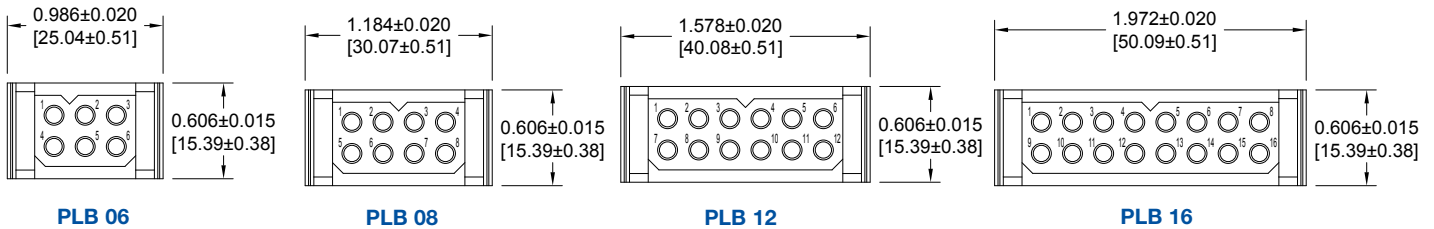
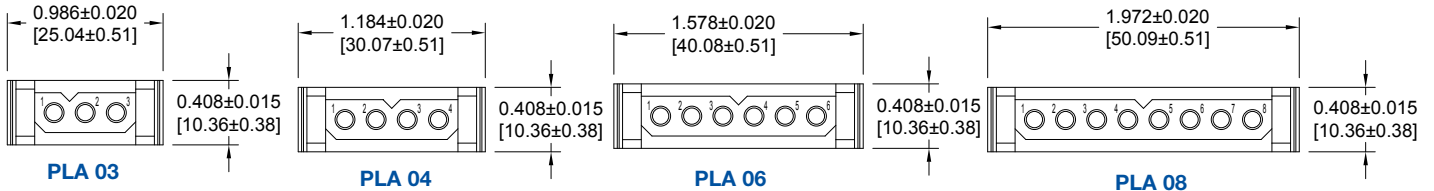
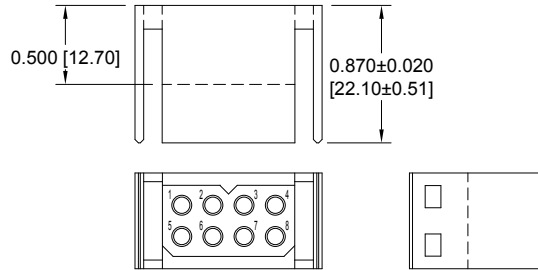

PLC 30

*For information regarding  
size 16 removable contacts,  
see Removable Contact section,  
pages 47-53.*



### FEMALE INSULATOR DIMENSIONS FOR CABLE CONNECTORS WITH SIZE 16 REMOVABLE CONTACTS

CODE 0 OR CODE 7

CONTACTS ARE NOT SUPPLIED WITH CONNECTOR AND MUST BE ORDERED SEPARATELY

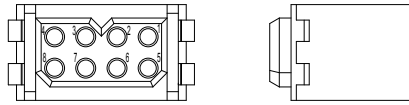
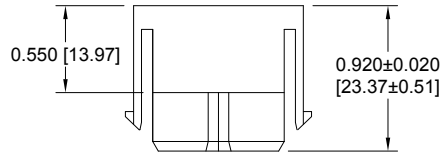

PCS SERIES

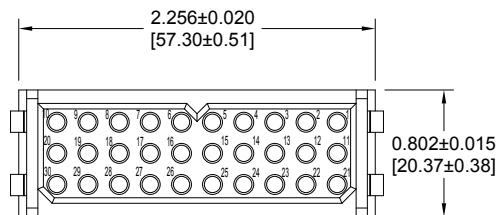
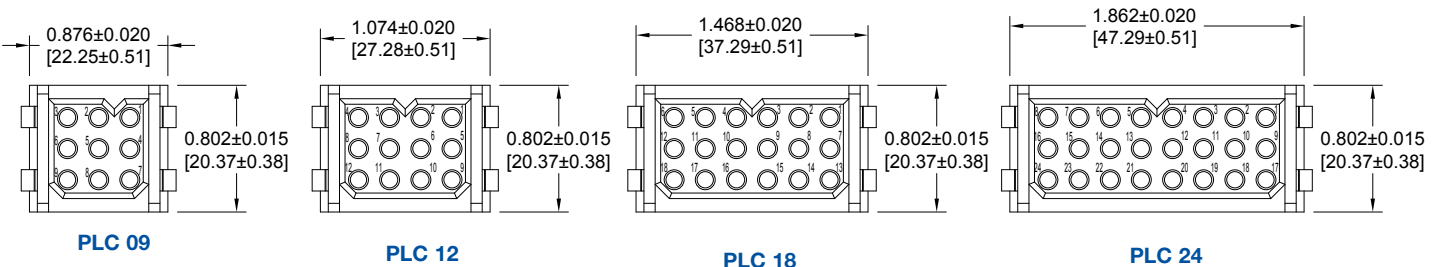
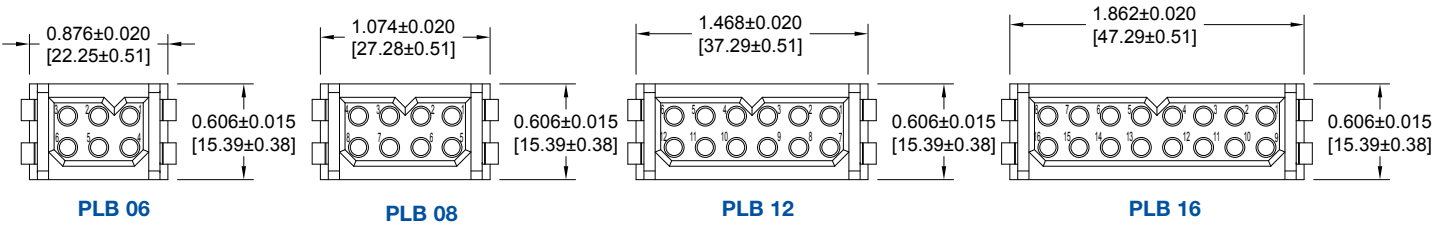
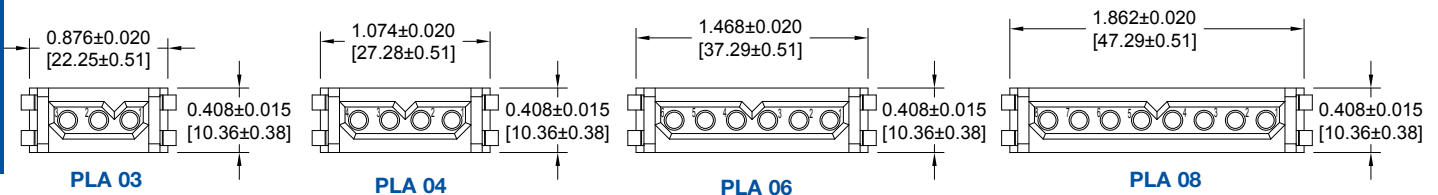

For information regarding size 16 removable contacts, see Removable Contact section, pages 47-53.

PLC 30

## MALE INSULATOR DIMENSIONS FOR PANEL MOUNT CONNECTORS WITH SIZE 16 REMOVABLE CONTACTS

CODE 1 OR CODE 8

CONTACTS ARE NOT SUPPLIED WITH CONNECTOR AND MUST BE ORDERED SEPARATELY

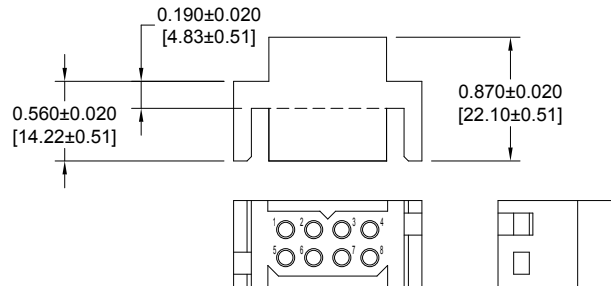

**NOTE:** MOUNTING SCREWS CAN BE SUPPLIED WITH CONNECTORS USING STEP 5 IN ORDERING INFORMATION ON PAGE 26. MOUNTING SCREWS CAN ALSO BE ORDERED SEPARATELY BY PART NUMBER. SEE PAGE 59.

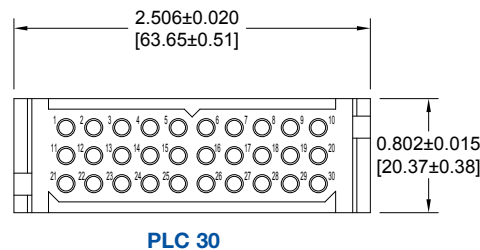
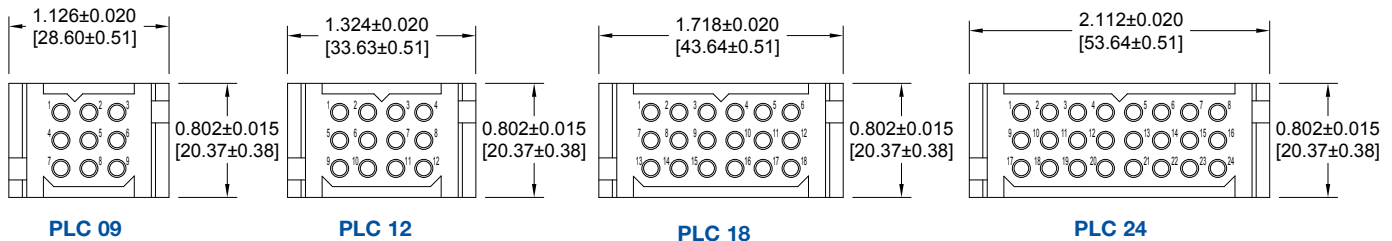
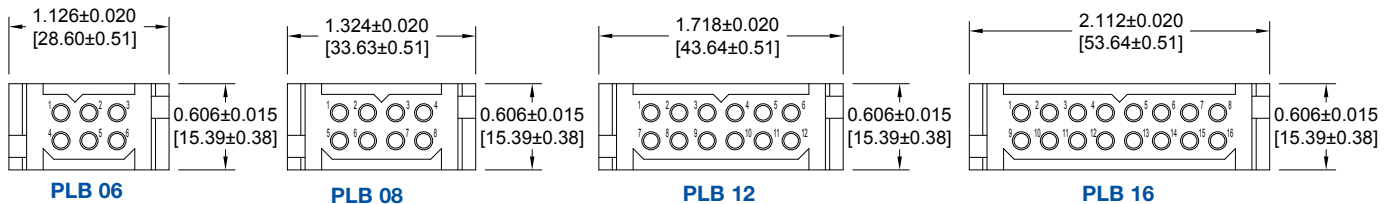
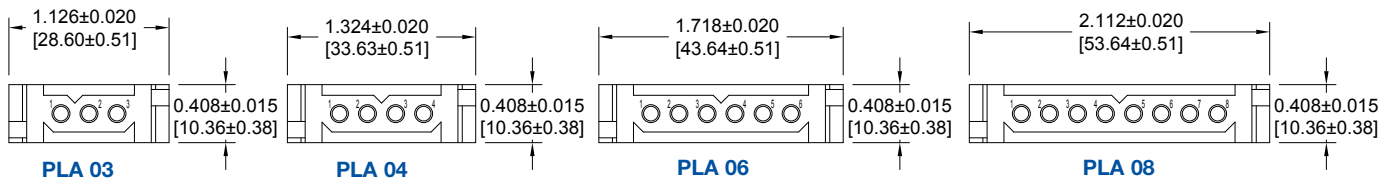

For information regarding panel cutouts, see page 63.

For information regarding size 16 removable contacts, see Removable Contact section, pages 47-53.

PCS SERIES



### FEMALE INSULATOR DIMENSIONS FOR PANEL MOUNT CONNECTORS WITH SIZE 16 REMOVABLE CONTACTS

CODE 1 OR CODE 8

CONTACTS ARE NOT SUPPLIED WITH CONNECTOR AND MUST BE ORDERED SEPARATELY

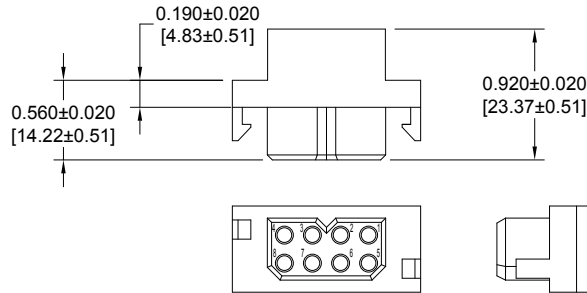

**NOTE:** MOUNTING SCREWS CAN BE SUPPLIED WITH CONNECTORS USING STEP 5 IN ORDERING INFORMATION ON PAGE 26. MOUNTING SCREWS CAN ALSO BE ORDERED SEPARATELY BY PART NUMBER. SEE PAGE 59.

PCS SERIES

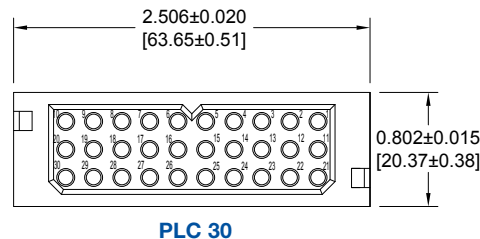
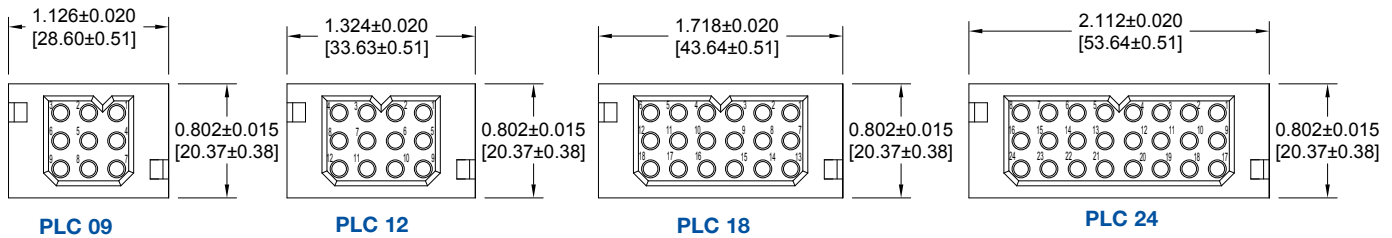
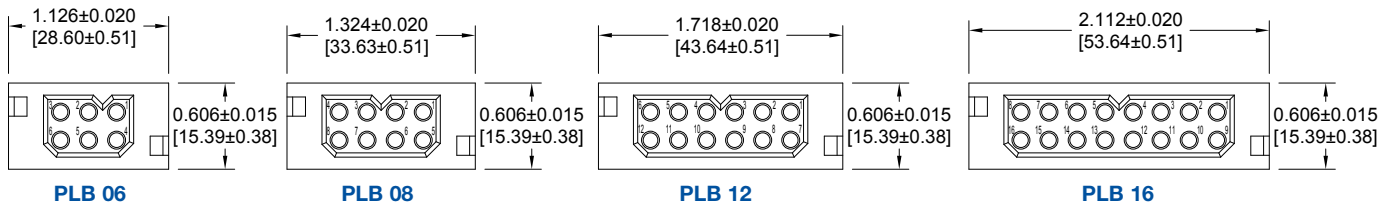
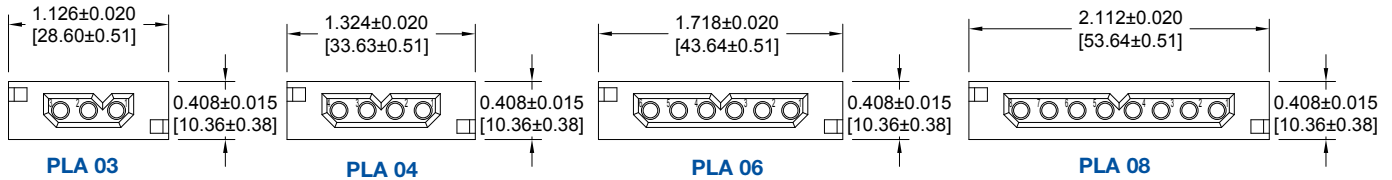

For information regarding panel cutouts, see page 63.

For information regarding size 16 removable contacts, see Removable Contact section, pages 47-53.

## SEQUENTIAL MATING SYSTEM

\*REMOVABLE CONTACTS FOR CABLE CONNECTORS MUST BE ORDERED SEPARATELY  
FOR CONTACT SELECTION, SEE SIZE 16 CONTACTS ON PAGE 49

**EXAMPLE 1**

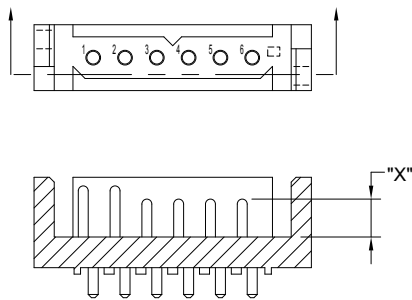

Typical Part Number:  
PLA06M300A1-E1B2B

LENGTH CODE	"X" CONTACT LENGTH
A	0.370 [9.40]
B	0.330 [8.38]
C	0.310 [7.87]
D	0.290 [7.37]
E	0.250 [6.35]

MATING CONNECTOR TYPE	CONTACT OPTIONS
Board to Board	B, D, E
Board to Cable*	A, C, E
Cable to Cable*	A, D

**EXAMPLE 2**

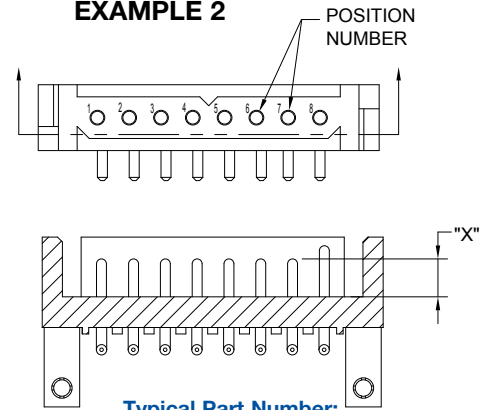

Typical Part Number:  
PLA08M4B0C1-D8B

## SEQUENTIAL MATING SYSTEM CRIMP REMOVABLE CONTACT PART NUMBERS

WIRE SIZE AWG/[mm <sup>2</sup> ]	LENGTH CODE "A"	LENGTH CODE "C"	LENGTH CODE "D"	LENGTH CODE "E"
12 - 14 [4.0 - 2.5]	MC112N-133.3	MC112N-133.2	MC112N-133.1	MC112N-133.0
16 - 18 - 20 [1.5 - 1.0 - 0.5]	MC116N-133.3	MC116N-133.2	MC116N-133.1	MC116N-133.0

*For information regarding  
size 16 removable contacts,  
see Removable Contact section, pages  
47-53.*

## SELECTION GUIDE FOR ORDERING DIFFERENT CONTACT LENGTHS

### STEP 9 OF ORDERING INFORMATION

SELECT CONNECTOR USING ORDERING INFORMATION ON PAGE 26  
THEN CHOOSE STEPS BELOW FOR SEQUENTIAL MATING SYSTEM CONTACTS

STEP	1	2	3	4	5	6	7	8	9
EXAMPLE	E	1	B	2	B	3	D	4	D

**STEP 1**

Specify code for most frequently used contact mating length. This length is used for all contacts not specified in steps 2 through 9.

**STEP 2**

Position number for first special length contact.

**STEP 3**

Length of contact specified in step 2. (Choose from length code chart)

**STEP 4**

Position number for second special length contact.

**STEP 9**

Length of contact specified in step 8 (Choose from length code chart).

**STEP 8**

Position number for fourth special length contact.

**STEP 7**

Length of contact specified in step 6 (Choose from length code chart).

**STEP 6**

Position number for third special length contact.

**STEP 5**

Length of contact specified in step 4 (Choose from length code chart).



## ORDERING INFORMATION - CODE NUMBERING SYSTEM

Specify Complete Connector By Selecting An Option From Step 1 Through 7

STEP	1	2	3	4	5	6	7	8	9
<b>EXAMPLE</b>	<b>PLB</b>	<b>06</b>	<b>F</b>	<b>3</b>	<b>0</b>	<b>0</b>	<b>A1</b>	<b>/AA</b>	
<b>STEP 1 - BASIC SERIES</b> PLA - 1 Row PLAH - 1 Row High conductivity contacts PLB - 2 Row PLBH - 2 Row High conductivity contacts PLC - 3 Row PLCH - 3 Row High conductivity contacts									<b>STEP 9 - SPECIAL OPTIONS</b> Sequential Mating Systems refer to page 25. <i>CONTACT TECHNICAL SALES FOR SPECIAL OPTIONS</i>
<b>STEP 2 - CONNECTOR VARIANTS</b> 1 Row - 03, 04, 06, 08 2 Row - 06, 08, 12, 16, *20 3 Row - 09, 12, 18, 24, 30									<b>STEP 8 - ENVIRONMENTAL COMPLIANCE OPTIONS</b>  /AA - RoHS Compliant  <b>NOTE:</b> If compliance to environmental legislation is not required, this step will not be used. Example: PLB06F300A1
<b>STEP 3 - CONNECTOR GENDER</b> M - Male F - Female									<b>STEP 7 - CONTACT PLATING FOR PRINTED BOARD CONNECTORS</b> 0 - Crimp Contacts ordered separately, see pages 47-53. A1 - Gold flash over nickel on mating end and termination end. A2 - Gold flash over nickel on mating end and 0.00020 inch [5.00µ] tin-lead solder coat on termination end. Not available with code 62, 63, 92 or 93 in step 4. C1 - 0.000030 inch [0.76µ] gold over nickel on mating end and termination end. C2 - 0.000030 inch [0.76µ] gold over nickel on mating end and 0.00020 inch [5.00µ] tin-lead solder coated termination end. Not available with code 62, 63, 92 or 93 in step 4. D1 - 0.000050 inch [1.27µ] gold over nickel on mating end and termination end. D2 - 0.000050 inch [1.27µ] gold over nickel on mating end and 0.00020 inch [5.00µ] tin-lead solder coated termination end. Not available with code 62, 63, 92 or 93 in step 4.
<b>STEP 4 - CONTACT TERMINATION TYPE</b> *10 - Order contacts separately for cable connectors for connection systems 5, 6, 7, 8 and 9, see pages 47-53. *11 - Removable contact, panel mounted connector for connection system 8. Order contacts separately, see pages 47-53. 2 - Solder cup, 18 AWG [1.0mm <sup>2</sup> ] max. for panel mount connector, for connection system 8. Not available as PL*H. 3 - Solder, Straight Printed Board Mount with 0.146 [3.71] tail extension for connection systems 1, 4 and 6. 32 - Solder, Straight Printed Board Mount with 0.377 [9.58] tail extension for connection system 3 and systems 1, 4 and 6. 4 - Solder, Right Angle (90°) Printed Board Mount with 0.146 [3.71] tail extension for connection systems 1, 2 and 5. 42 - Solder, Right Angle (90°) Printed Board Mount with 0.377 [9.58] tail extension for connection system 3 and systems 1,2 and 5. 62 - Press-in, compliant termination Right Angle (90°) Printed Board Mount, termination length 0.183 [4.65]. Must select "B3" in step 5. 63 - Press-in, compliant termination Right angle (90°) Printed Board Mount, termination length 0.219 [5.56]. Must select "B3" in step 5. *17 - Order contacts separately for cable connectors for connection systems 5, 6, 7, 8 and 9, see pages 47-53. Terminating side of insulator has 0.165 [4.19] ø c'bore for large wire sizes. *18 - Removable contact, panel mounted connector for connection system 8. Order contacts separately, see pages 47-53. Terminating side of insulator has 0.165 [4.19] ø c'bore for large wire sizes. 92 - Straight printed board mount, press-in, length 0.183 [4.65] for 0.093 inch [2.36] thick board. 93 - Straight printed board mount, press-in, length 0.218 [5.54] for 0.125 inch [3.18] thick board.									<b>STEP 6 - HOODS AND PANEL MOUNT</b> 0 - None. 5 - Top Opening Hood. 6 - Panel Mount, quick release. 81 - Panel Mount, fixed for 0.040 [1.02] thick panel. 82 - Panel Mount, fixed for 0.060 [1.52] thick panel. 83 - Panel Mount, fixed for 0.090 [2.29] thick panel. 11 - Blind Mating System for 0.040 [1.02] thick panel. 12 - Blind Mating System for 0.060 [1.52] thick panel. 13 - Blind Mating System for 0.090 [2.29] thick panel. 14 - Blind Mating System for 0.120 [3.05] thick panel.
<b>STEP 5 - MOUNTING STYLE</b> 0 - None, B - Metal Right Angle (90°) Mounting Bracket. BN - Metal Right Angle (90°) Mounting Bracket with Push-on Fastener. B3 - Plastic Right Angle (90°) Mounting Bracket with Cross Bar. B3N - Plastic Right Angle (90°) Mounting Bracket with Cross Bar and Push-on Fastener. N - Push-On Fastener For Straight Printed Board Mount Connectors *ST2 - Self-tapping steel screws 2-28 x 0.250±0.030 [6.35±0.76] length for 0.093 [2.36] thick board. *ST3 - Self-tapping steel screws 2-28 x 0.312±0.030 [7.92±0.76] length for 0.125 [3.18] thick board. *ST4 - Self-tapping steel screws 2-28 x 0.375±0.030 [9.53±0.76] length for 0.175 [4.45] thick board. *SS2 - Self-tapping stainless steel screws 2-28 x 0.250±0.030 [6.35±0.76] length for 0.093 [2.36] thick board. *SS3 - Self-tapping stainless steel screws 2-28 x 0.312±0.030 [7.92±0.76] length for 0.125 [3.18] thick board. *SS4 - Self-tapping stainless steel screws 2-28 x 0.375±0.030 [9.53±0.76] length for 0.175 [4.45] thick board.									<b>*1 For high conductivity removable contact connectors, order PLA, PLB, or PLC connectors (in Step 1) and *C112N(2)S contacts found on pages 49-51.</b> <b>*2 PLB20 variant available with code 2, 3, 32, 4, 42, 92, and 93 only in Step 4.</b> <b>*3 Mounting screws are available with code 1, 2, 3, 32, 8, 92 and 93. To order mounting screws separately, see page 59 for part numbers.</b>



## Safety Shrouded Connector to Prevent Unsafe Exposure to High Energy Circuits

- \* Size 12 Power Contacts
- \* Large Surface Area Mating System
- \* Discriminating Locking System
- \* Contact Current Rating to 40 Amperes
- \* Board - Cable / Cable - Cable



## TECHNICAL CHARACTERISTICS

### MATERIALS AND FINISHES:

<b>Insulator:</b>	Glass-filled polyester, UL 94V-0. Contact technical sales for availability of high temperature insulator material.
<b>Contacts:</b>	Precision machined copper alloy with gold flash over nickel, or 0.000030 inch [0.76 $\mu$ ] gold over nickel, or 0.000050 [1.27 $\mu$ ] gold over nickel. Solder coated terminations optional.
<b>Push-on Fastener:</b>	Spring tempered copper alloy, tin plate.

### ELECTRICAL CHARACTERISTICS:

<b>Contact Current Rating:</b>	40 amperes continuous, derated per IEC 60512-3, test 5b. Higher currents available with high conductivity contacts, contact Technical Sales
<b>Initial Contact Resistance:</b>	0.001 ohms max. per IEC 60512-2, test 2b.
<b>Insulation Resistance:</b>	5 G ohms per IEC 60512-2, test 3a.
<b>Voltage Proof:</b>	3,000 minimum V r.m.s. per IEC 60512-2, test 4a, method A.
<b>Clearance and Creepage Distance:</b>	0.220 [5.60] minimum
<b>Working Voltage:</b>	600 minimum V. r.m.s.
<b>Hot Pluggable [50 couplings per UL 1977 paragraph 15]:</b>	250 VAC at 20 amperes
<b>Working Temperature:</b>	-55°C to +125°C Contact technical sales for availability of high temperature insulator material.

### MECHANICAL CHARACTERISTICS:

<b>Removable Contacts:</b>	Rear insertion/ front release. Female contact features "Closed Entry" design for highest reliability. 0.094 [2.39] diameter male contact.
<b>Removable Contact Retention in Insulator:</b>	15 lbs. [67N] per IEC 60512-8, test 15a.
<b>Fixed Contacts:</b>	Printed board terminations, both straight and 90°. Female contact features "Closed Entry" design for highest reliability. 0.094 [2.39] diameter male contact.
<b>Fixed Contact Retention in Insulator:</b>	15 lbs. [67N], minimum.
<b>Resistance to Soldering Iron Heat:</b>	500°F [260°C] for 10 seconds duration per IEC 60512-6, test 12e, 25 watt soldering iron.
<b>Contact Terminations:</b>	Crimp removable contacts for wire size 12 AWG [4.0 mm <sup>2</sup> ]. Straight and right angle (90°) solder printed board mount, 0.090 [2.29] tail diameter.
<b>Connection Systems:</b>	Cable to cable, cable to printed board and cable to panel mount.
<b>Locking System:</b>	Insulators provide locking between cable to cable, cable to printed board and cable to panel mount applications.
<b>Polarization:</b>	Provided in insulator design.
<b>Mounting to P.C. Board:</b>	Rapid installation push-on fasteners.
<b>Mechanical Operations:</b>	500 operations



### CONNECTION SYSTEMS

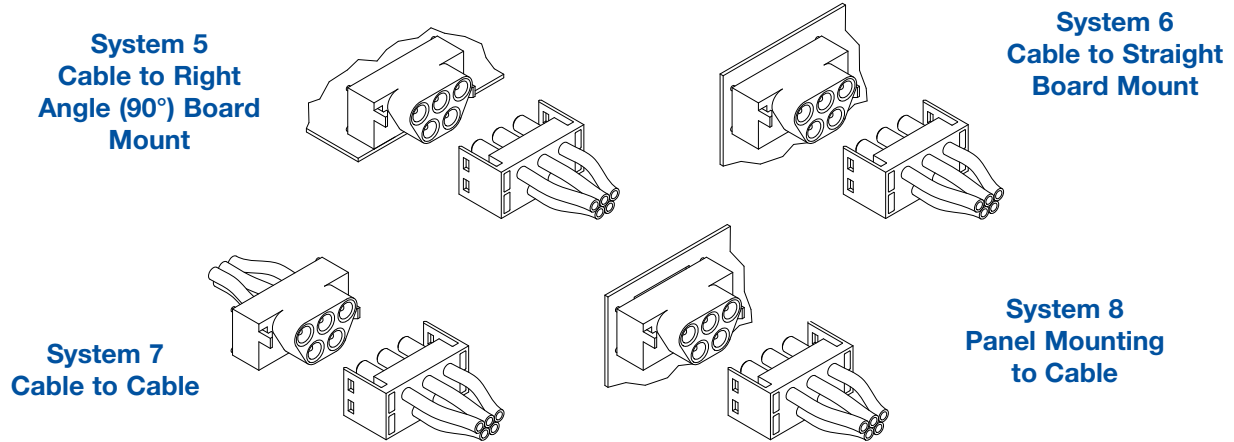

### CONNECTOR VARIANTS

FACE VIEW OF MALE OR REAR VIEW OF FEMALE CONNECTOR

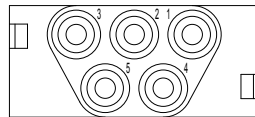

PLS5W5

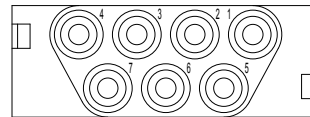

PLS7W7

### FEMALE CABLE CONNECTOR FOR CABLE CONNECTORS WITH SIZE 12 REMOVABLE CONTACTS CODE 0

CONTACTS ARE NOT SUPPLIED WITH CONNECTOR AND MUST BE ORDERED SEPARATELY

PART NUMBER	A
PLS5W5F0000	1.655 [42.04]
PLS7W7F0000	2.072 [52.64]

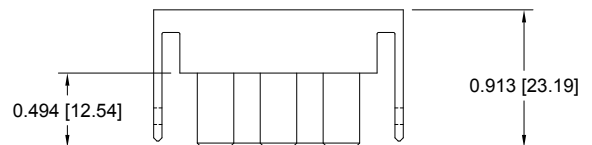

Typical part number:  
PLS5W5F00000

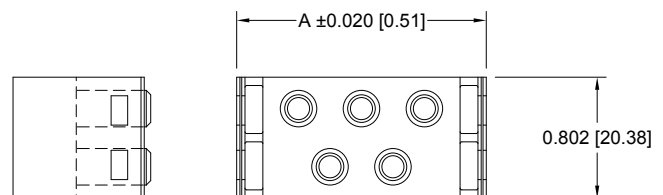

*For information regarding size 12 removable contacts, see Removable Contact section, pages 47-53.*

**MALE PANEL MOUNT CONNECTOR  
FOR PANEL MOUNT CONNECTORS WITH SIZE 12 REMOVABLE CONTACTS  
CODE 1**

CONTACTS ARE NOT SUPPLIED WITH CONNECTOR AND MUST BE ORDERED SEPARATELY

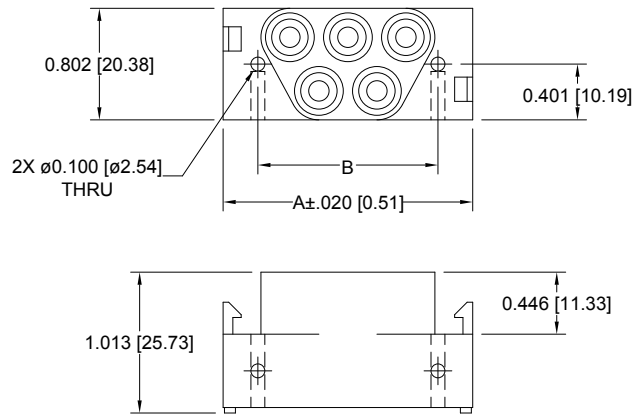

Typical part number:  
PLS5W5M10000

PART NUMBER	A	B
PLS5W5M10000	1.795 [45.60]	1.295 [32.90]
PLS7W7M10000	2.213 [56.20]	1.713 [43.50]

**FEMALE PANEL MOUNT CONNECTOR  
FOR PANEL MOUNT CONNECTORS WITH SIZE 12 REMOVABLE CONTACTS  
CODE 1**

CONTACTS ARE NOT SUPPLIED WITH CONNECTOR AND MUST BE ORDERED SEPARATELY

Typical part number:  
PLS5W5F10000

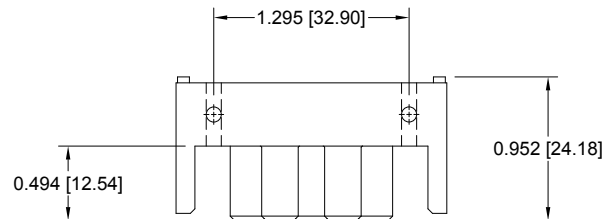

\*CONTACT TECHNICAL SALES  
FOR AVAILABILITY OF 7W7 VARIANT.

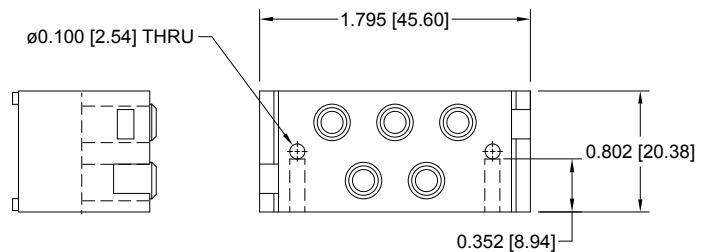

For information regarding size 12 removable contacts, see Removable Contact section, pages 47-53.



## MALE STRAIGHT PRINTED BOARD MOUNT CONNECTOR CODE 3, 0.146 [3.71] CONTACT EXTENSION

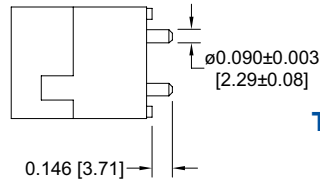
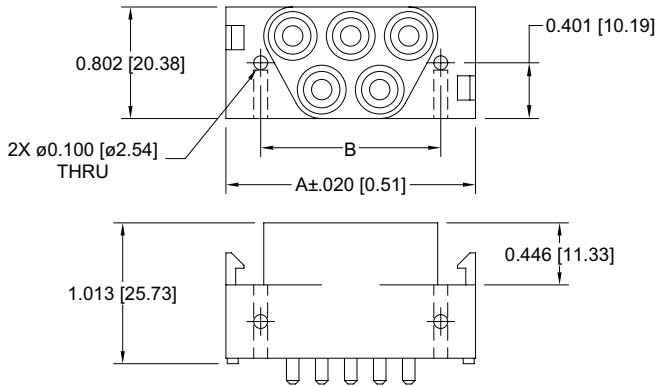

Typical part number:  
**PLS5W5M300A1**

PART NUMBER	A	B
PLS5W5M300A1	1.795 [45.60]	1.295 [32.90]
PLS7W7M300A1	2.213 [56.20]	1.713 [43.50]

## MALE RIGHT ANGLE (90°) PRINTED BOARD MOUNT CONNECTOR CODE 4, 0.146 [3.71] CONTACT EXTENSION

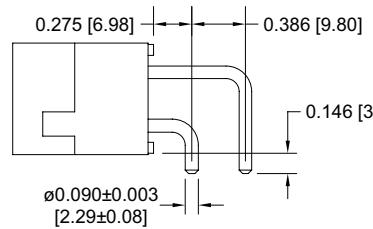
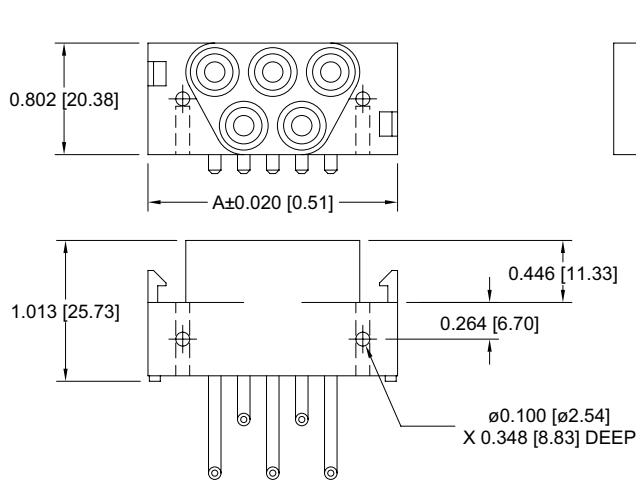

Typical part number:  
**PLS5W5M400A1**

PART NUMBER	A	B
PLS5W5M400A1	1.795 [45.60]	1.295 [32.90]
PLS7W7M400A1	2.213 [56.20]	1.713 [43.50]

## PRINTED BOARD CONTACT HOLE PATTERNS

### STRAIGHT SOLDER

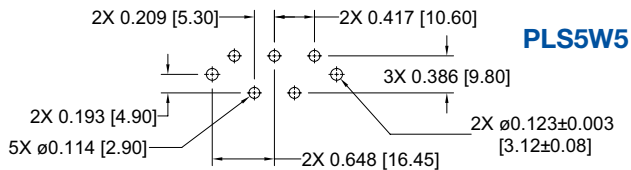

**PLS5W5**

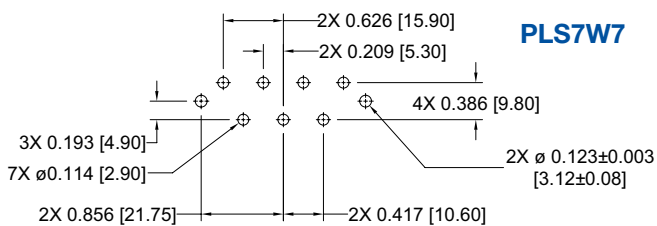

**PLS7W7**

### RIGHT ANGLE (90°)

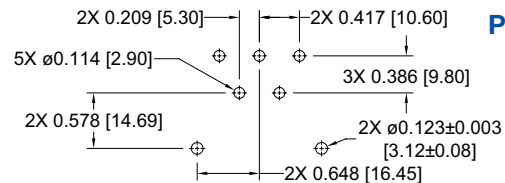

**PLS5W5**

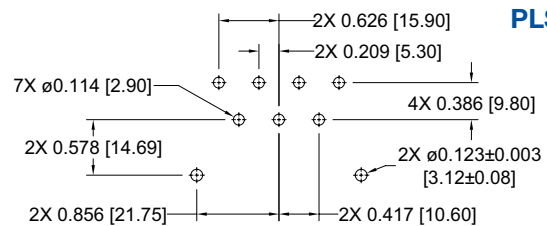

**PLS7W7**

**ORDERING INFORMATION - CODE NUMBERING SYSTEM**

Specify Complete Connector By Selecting An Option From Step 1 Through 7

STEP	1	2	3	4	5	6	7	8	9
<b>EXAMPLE</b>	PLS	5W5	M	4	0	0	A1	/AA	
<p><b>STEP 1 - BASIC SERIES</b> PLS - PLS Series PLSH - High conductivity contacts</p> <p><b>STEP 2 - CONNECTOR VARIANTS</b> 5W5 - Five size 12 contacts 7W7 - Seven size 12 contacts</p> <p><b>STEP 3 - CONNECTOR GENDER</b> M - Male F - Female</p> <p><b>STEP 4 - CONTACT TERMINATION TYPE</b> 0 - Order contacts separately for cable connectors for connection systems 5, 6, 7 and 8, see pages 47-53. Female connectors only. ** 1 - Order contacts separately for Panel Mount connectors for connection system 7, see pages 47-53. For 7W7 female variant consult technical sales. 3 - Solder, Straight Printed Board Mount with 0.146 [3.71] tail extension for connection system 6. Male connectors only. *** 4 - Solder, Right Angle (90°) Printed Board Mount with 0.146 [3.71] tail extension for connection system 5. Male connectors only. ***</p> <p><b>STEP 5 - MOUNTING STYLE</b> 0 - None. N - Push-on Fastener for Straight Printed Board Mount Connectors</p>									<p><b>STEP 9 - SPECIAL OPTIONS</b> CONTACT TECHNICAL SALES FOR SPECIAL OPTIONS</p> <p><b>STEP 8 - ENVIRONMENTAL COMPLIANCE OPTIONS</b> /AA - RoHS Compliant  <b>NOTE:</b> If compliance to environmental legislation is not required, this step will not be used. Example: PLS5W5M400A1</p> <p><b>STEP 7 - CONTACT PLATING FOR PRINTED BOARD CONNECTORS</b> 0 - Crimp Contacts ordered separately, see pages 47-53. A1 - Gold flash over nickel on mating end and termination end. A2 - Gold flash over nickel on mating end and 0.00020 inch [5.00µ] tin-lead solder coat on termination end. C1 - 0.000030 inch [0.76µ] gold over nickel on mating end and termination end. C2 - 0.000030 inch [0.76µ] gold over nickel on mating end and 0.00020 inch [5.00µ] tin-lead solder coated termination end. D1 - 0.000050 inch [1.27µ] gold over nickel on mating end and termination end. D2 - 0.000050 inch [1.27µ] gold over nickel on mating end and 0.00020 inch [5.00µ] tin-lead solder coated termination end.</p> <p><b>STEP 6 - CABLE ADAPTER</b> 0 - None 5 - Top Opening Hood, see accessories section page 60.</p>

\*\* Consult technical sales for availability of male version of contact type 0.

\*\*\* Consult technical sales for availability of female version of contact type 3 and 4.

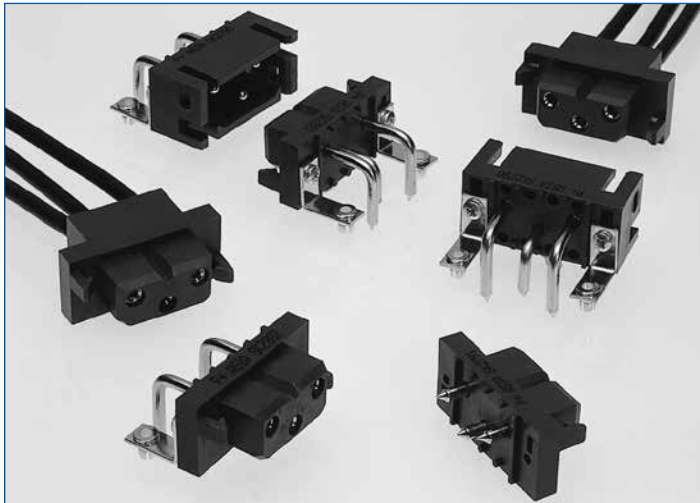

### A.C. / D.C. INPUT CONNECTOR

- \* Hot Plug Capability
- \* Screw Termination Contacts
- \* Size 12 Power Contacts
- \* Large Surface Area Mating System
- \* Contact Current Rating to 40 Amperes
- \* Sequential Mating Options
- \* Discriminating Locking System

## TECHNICAL CHARACTERISTICS

### MATERIALS AND FINISHES:

<b>Insulator:</b>	Glass-filled polyester, UL 94V-0. Contact technical sales for availability of high temperature insulator material.
<b>Contacts:</b>	Precision machined copper alloy with gold flash over nickel, or 0.000030 inch [0.76µ] gold over nickel, or 0.000050 [1.27µ] gold over nickel. Solder coated terminations optional.
<b>Hood:</b>	Glass-filled polyester, UL 94V-0.
<b>Mounting Bracket:</b>	Brass, tin plate.
<b>Push-on Fastener:</b>	Spring tempered copper alloy, tin plate.
<b>Mounting Screw:</b>	Steel, zinc plate, or stainless steel passivated.

### ELECTRICAL CHARACTERISTICS:

#### CONTACT CURRENT RATING:

**Standard Contact Material:** 40 amperes. See page 33 for details.

#### High Conductivity

**Contact Material:** 55 amperes. See page 33 for details.

#### INITIAL CONTACT RESISTANCE:

**Standard Contact Material:** 0.001 ohms max. per IEC 60512-2, test 2b.

#### High Conductivity

**Contact Material:** 0.00037 ohms max. per IEC 60512-2, test 2b.

**Insulation Resistance:** 5 G ohms per IEC 60512-2, test 3a.

**Voltage Proof:** 3,750 V r.m.s. per IEC 60512-2, test 4a, method A.

#### Clearance and

**Creepage Distance:** 0.125 [3.18] minimum

**Working Voltage:** 1,250 V. r.m.s.

**Hot Pluggable [50 couplings per UL 1977 paragraph 15]:**

**Working Temperature:** Contact technical sales  
-55°C to +125°C  
Contact technical sales for availability of high temperature insulator material.

### MECHANICAL CHARACTERISTICS:

<b>Removable Contacts:</b>	Rear insertion/ front release. Female contact features "Closed Entry" design for highest reliability. 0.094 [2.39]
<b>Removable Contact Retention in Insulator:</b>	20 lbs. [89N] per IEC 60512-8, test 15a.
<b>Fixed Contacts:</b>	Printed board terminations, both straight and right angle (90°). Female contact features "Closed Entry" design for highest reliability. 0.094 [2.39] diameter male contact.
<b>Fixed Contact Retention in Insulator:</b>	10 lbs. [44N], minimum.
<b>Resistance to Soldering Iron Heat:</b>	260°C [500°F] for 10 seconds duration per IEC 60512-6, test 12e, 25 watt soldering iron.
<b>Contact Terminations:</b>	Crimp removable contacts and solder cup removable contacts for wire size 12 AWG [4.0 mm <sup>2</sup> ]. Straight and right angle (90°) solder printed board mount, 0.090 [2.29] tail diameter. Compliant termination press-in.
<b>Connection Systems:</b>	Cable to cable, cable to printed board, cable to panel mount, and printed board to printed board.
<b>Sequential Mating Systems:</b>	Male contacts can provide two mating lengths.
<b>Locking System:</b>	Insulators provide locking between cable to cable, cable to printed board, and cable to panel mount applications.
<b>Polarization:</b>	Provided in insulator design.
<b>Mounting to P.C. Board:</b>	Rapid installation push-on fasteners.
<b>Mechanical Operations:</b>	500 operations



## CONNECTION SYSTEMS

**System 1**  
Mother Board -  
Daughter Board

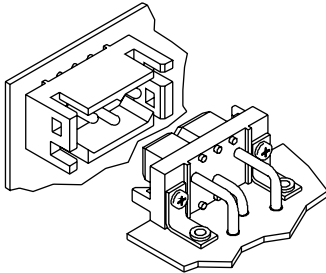

**System 2**  
Side to Side  
Board Mounting

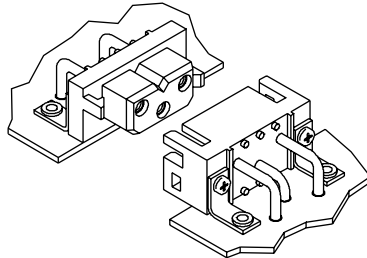

**System 4**  
Sandwich Board  
Mounting

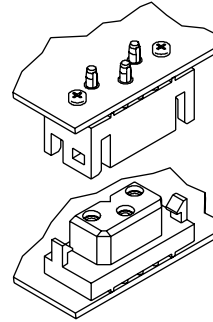

**System 5**  
Cable to Right  
Angle (90°)  
Board Mount

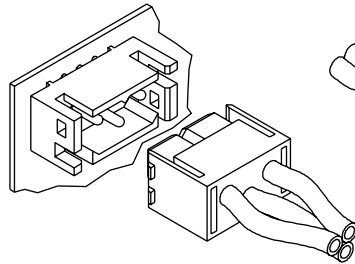
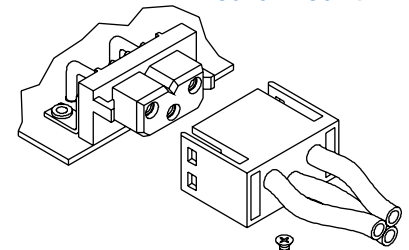

**System 6**  
Cable to Straight  
Board Mount

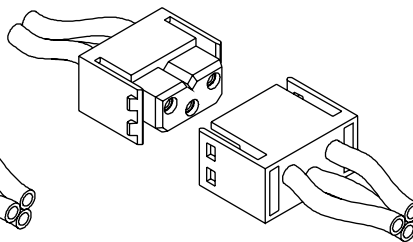

**System 7**  
Cable to Cable

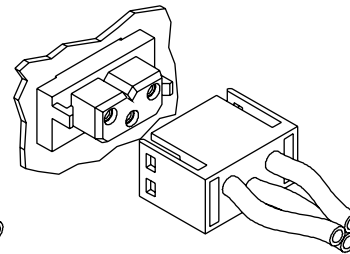

**System 8**  
Panel Mounting  
to Cable

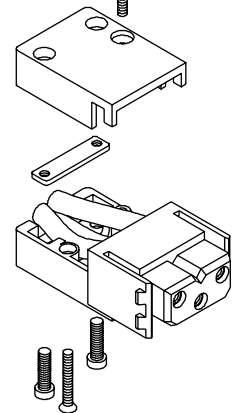

**System 9**  
Cable Connector with  
Cable Adapter

## TEMPERATURE RISE CURVE

### STANDARD CONTACT MATERIALS

CONNECTORS WITH PLB PREFIX

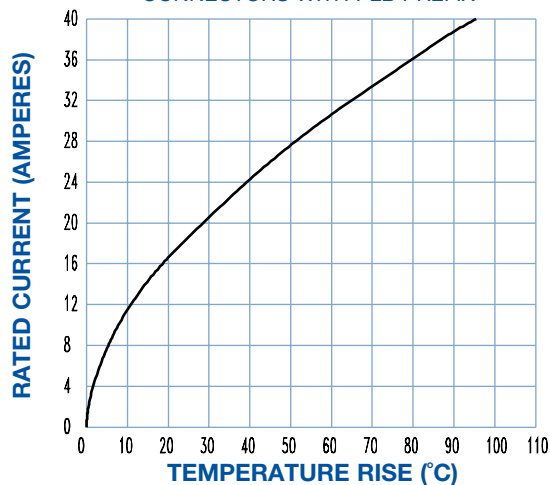

Test conducted per IEC Publication 60512-3, Test 5a.  
All power contacts under load.

**Standard Density:** Curve developed using PLB3W3M4BN0A1 and PLB3W3F300A1 mated connector terminated to 12 AWG wire.

**High Conductivity:** Curve developed using PLBH3W3M9300A1 and PLBH3W3F9300A1 mated connector terminated to 12 AWG wire

### HIGH CONDUCTIVITY CONTACT MATERIALS

CONNECTORS WITH PLBH PREFIX  
OR "S" SUFFIX ON CRIMP CONTACTS

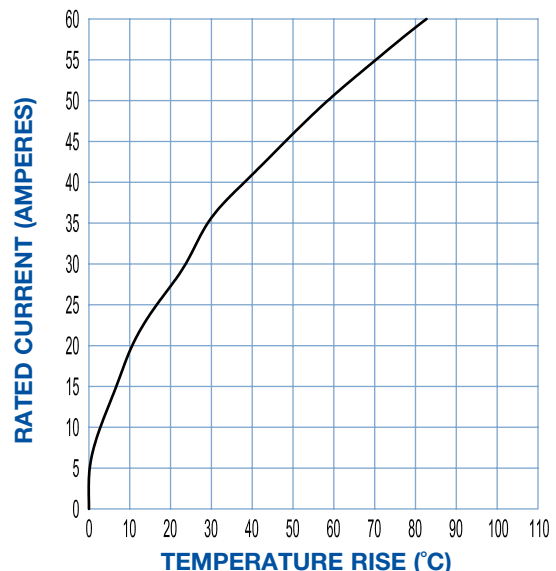



## CONNECTOR VARIANT FACE VIEW OF MALE CONNECTOR

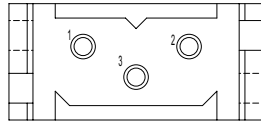

**PLB3W3**

## CABLE CONNECTOR FOR USE WITH SIZE 12 REMOVABLE CONTACTS CODE 0

CONTACTS ARE NOT SUPPLIED WITH CONNECTOR AND MUST BE ORDERED SEPARATELY

### MALE

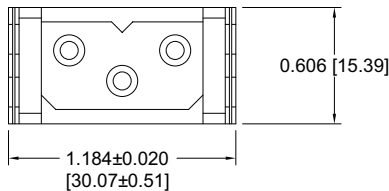

**Part Number: PLB3W3M0000**

### FEMALE

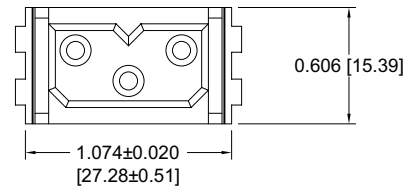

**Part Number: PLB3W3F0000**

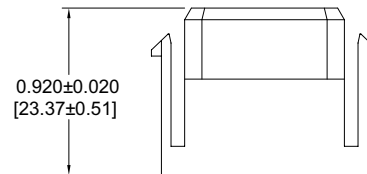
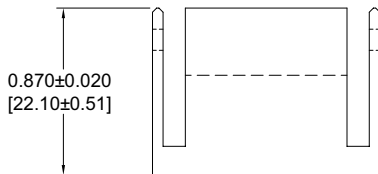

## PANEL MOUNT CONNECTOR FOR USE WITH SIZE 12 REMOVABLE CONTACTS CODE 1

CONTACTS ARE NOT SUPPLIED WITH CONNECTOR AND MUST BE ORDERED SEPARATELY

### MALE

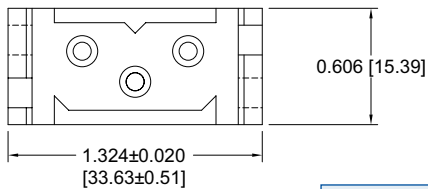

**Part Number: PLB3W3M1000**

### FEMALE

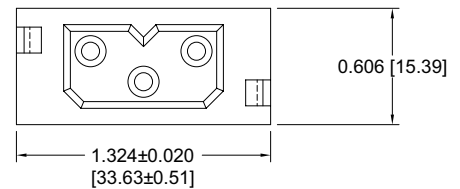

**Part Number: PLB3W3F1000**

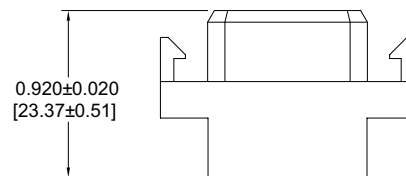
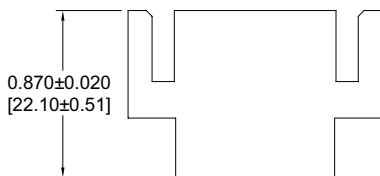

**NOTE:** MOUNTING SCREWS CAN BE SUPPLIED WITH CONNECTORS USING STEP 5 IN ORDERING INFORMATION ON PAGE 38. MOUNTING SCREWS CAN ALSO BE ORDERED SEPARATELY BY PART NUMBER. SEE PAGE 59.

*For information regarding size 12 removable contacts, see Removable Contact section, pages 47-53.*



**STRAIGHT PRINTED BOARD MOUNT CONNECTOR  
CODE 3, 0.146 [3.71] CONTACT EXTENSION**

**NOTE:** MOUNTING SCREWS CAN BE SUPPLIED WITH CONNECTORS USING STEP 5 IN ORDERING INFORMATION ON PAGE 38. MOUNTING SCREWS CAN ALSO BE ORDERED SEPARATELY BY PART NUMBER. SEE PAGE 59.

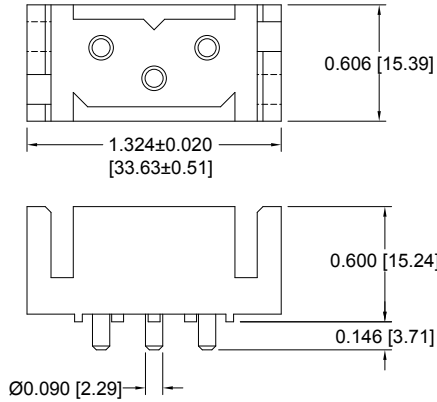

**Part Number: PLB3W3M300A1**

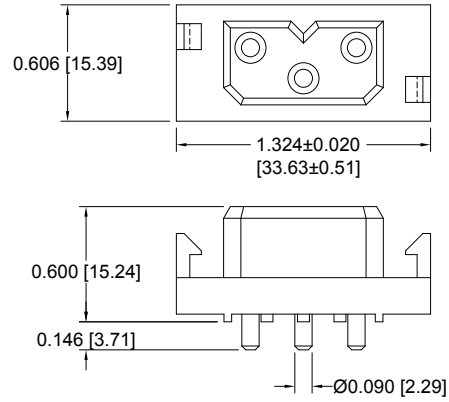

**Part Number: PLB3W3F300A1**

**COMPLIANT PRESS-IN CONNECTOR  
CODE 93, 0.225 [5.72] CONTACT EXTENSION**

**NOTE:** Positronic recommends the practice of using mounting hardware to secure connector to printed circuit board. Mounting screws can be supplied with connectors using step 5 in ordering information on page 38. Mounting screws can also be ordered separately by part number. See page 59.

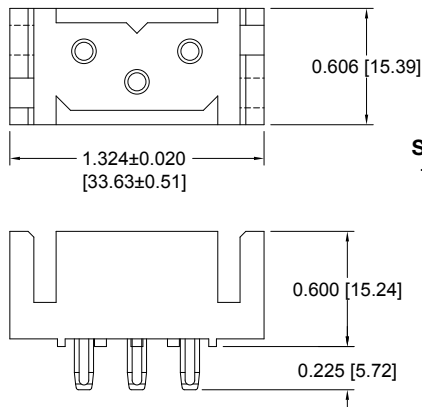

**Part Number: PLB3W3M93ST30A1**

See page 56-57  
for Compliant  
Press-in  
information.

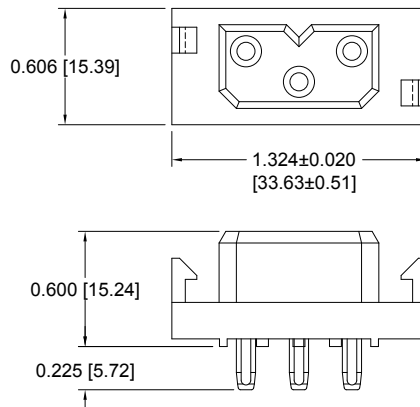

**Part Number: PLB3W3F93ST30A1**

**CONTACT HOLE PATTERN**

FOR STRAIGHT PRINTED BOARD MOUNT AND COMPLIANT PRESS-IN CONNECTORS

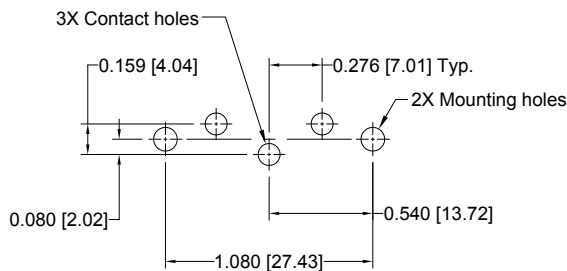

**SUGGESTED PRINTED BOARD HOLE SIZES:**

Suggest Ø 0.114 [2.90] finished holes in printed board for straight solder printed board mount contacts.

Suggest Ø 0.123±0.003 [3.15±0.08] holes in printed board for mounting connector with push-on fasteners or 0.100 [2.54] for mounting connector with #2 screws.

**NOTE:** See page 57 for suggested printed board drill hole sizes, recommended plating and finished hole sizes for compliant contact termination positions.



### RIGHT ANGLE (90°) PRINTED BOARD MOUNT CONNECTOR CODE 4, 0.146 [3.71] CONTACT EXTENSION

**MALE**

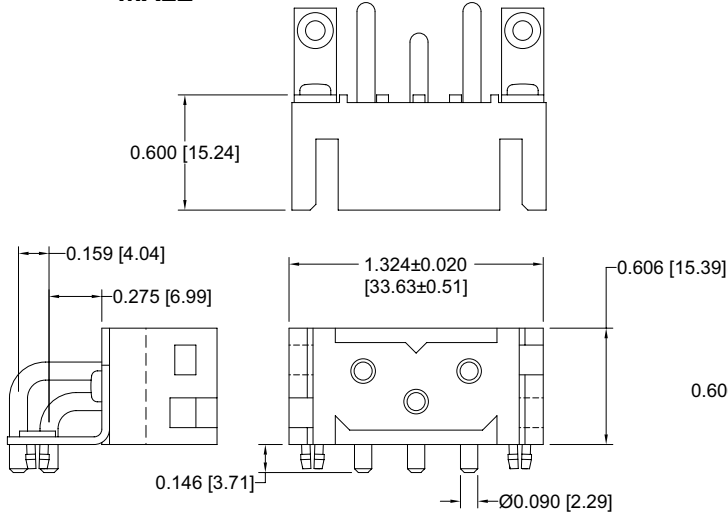

**Part Number:  
PLB3W3M4BN0A1**

**FEMALE**

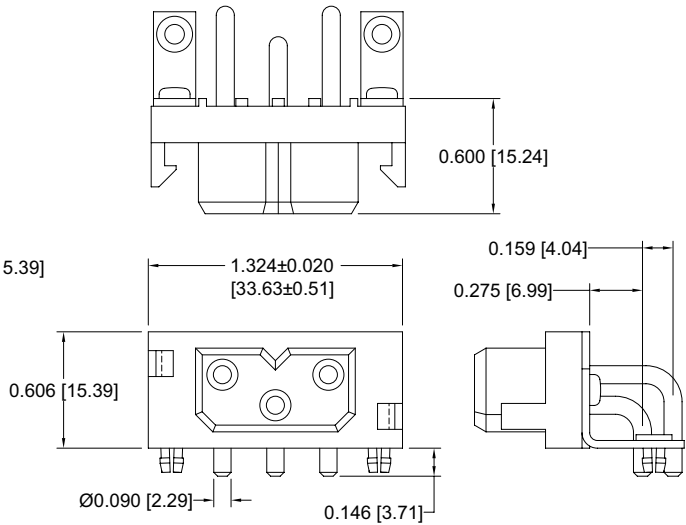

**Part Number:  
PLB3W3F4BN0A1**

### CONTACT HOLE PATTERN RIGHT ANGLE (90°) ANGLE PRINTED BOARD MOUNT CONNECTORS

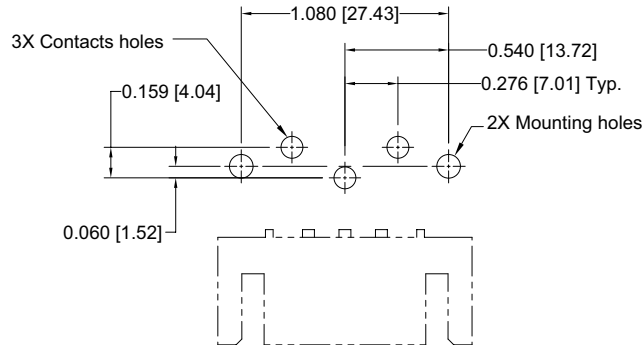

#### **SUGGESTED PRINTED BOARD HOLE SIZES:**

Suggest Ø 0.114 [2.90] finished holes in printed board for right angle (90°) solder printed board mount contacts.

Suggest Ø 0.123±0.003 [3.15±0.08] holes in printed board for mounting connector with push-on fasteners.

## SCREW TERMINATION CONNECTOR

SCREW TERMINATIONS ALLOWS FOR CONVENIENT FIELD INSTALLATION WHEN REQUIRED  
**CODE 71**

CONTACTS MAY BE SUPPLIED WITH CONNECTOR OR ORDERED SEPARATELY

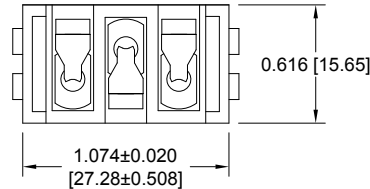

**Typical Part Number:**  
**PLB3W3F7100A1**  
supplied with 3 contacts

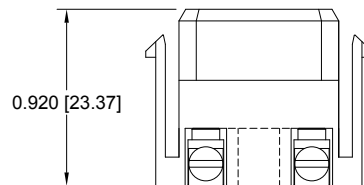

### REPLACEMENT CONTACT

For use with wire  
size 12 awg [4.0mm<sup>2</sup>]  
or smaller

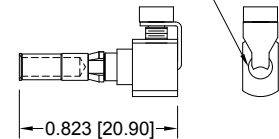

**Typical Part Number:**  
**FST612N2**

## SEQUENTIAL MATING CONTACTS

### BOARD MOUNT CONNECTORS

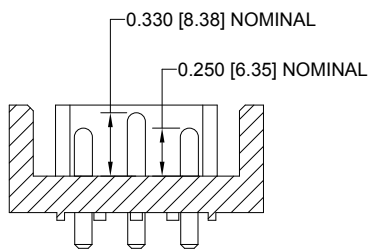

**Modification number -338.0** (see step 8 of the ordering information) allows for board mount connector to have position 3 loaded with a 0.330 [8.38] nominal mating length contact and positions 1 and 2 loaded with 0.250 [6.35] nominal mating length contacts. **Contact technical sales for additional sequencing options.**

### CRIMP AND PANEL MOUNT CONNECTORS

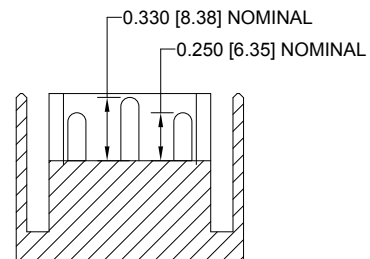

**MC610NS** and **MC612N** crimp contacts and **MC610NS** and **MC612N** solder cup contacts to be used for 0.330 [8.38] nominal mating length. **MC610NS-228.2** and **MC612N-228.2** crimp contacts and **MS610NS-228.2** and **MS612N-228.2** solder cup contacts to be used for 0.250 [6.35] nominal mating length.



### ORDERING INFORMATION - CODE NUMBERING SYSTEM

Specify Complete Connector By Selecting An Option From Step 1 Through 7

STEP	1	2	3	4	5	6	7	8	9
EXAMPLE	PLB	3W3	F	3	0	0	A1	/AA	

#### STEP 1 - BASIC SERIES

PLB - PLB Series  
PLBH - High conductivity contacts.

#### STEP 2 - CONNECTOR VARIANTS

3W3 - Three size 12 contacts

#### STEP 3 - CONNECTOR GENDER

M - Male  
F - Female

#### STEP 4 - CONTACT TERMINATION TYPE

- 0 - Order contacts separately for cable connectors for connection systems 5, 6, 7, 8 and 9, see pages 47-53.
- \*1 - Removable contact, panel mount connector for connection system 8. Order contacts separately, see pages 47-53.
- \*3 - Solder, Straight Printed Board Mount with 0.146 [3.71] tail extension for connection systems 1, 4, and 6.
- 4 - Solder, Right Angle (90°) Printed Board Mount with 0.146 [3.71] tail extension for connection systems 1, 2 and 5.
- 71 - Screw termination cable connector. Supplied with 3 contacts.
- \*93 - Press-in, Compliant Termination for 0.090 [2.29] to 0.175 [4.45] thick P.C. board, for connector systems 1, 4, and 6.

#### STEP 5 - MOUNTING STYLE

- 0 - None
- B - Metal Right Angle (90°) Mounting Bracket.
- BN - Metal Right Angle (90°) Mounting Bracket with Push-on Fastener.
- N - Push-On Fastener For Straight Printed Board Mount Connectors
- ST2 - Self-tapping steel screws 2-28 x 0.250±0.030 [6.35±0.76] length for 0.093 [2.36] thick board.
- ST3 - Self-tapping steel screws 2-28 x 0.312±0.030 [7.92±0.76] length for 0.125 [3.18] thick board.
- ST4 - Self-tapping steel screws 2-28 x 0.375±0.030 [9.53±0.76] length for 0.175 [4.45] thick board.
- SS2 - Self-tapping stainless steel screws 2-28 x 0.250±0.030 [6.35±0.76] length for 0.093 [2.36] thick board.
- SS3 - Self-tapping stainless steel screws 2-28 x 0.312±0.030 [7.92±0.76] length for 0.125 [3.18] thick board.
- SS4 - Self-tapping stainless steel screws 2-28 x 0.375±0.030 [9.53±0.76] length for 0.175 [4.45] thick board.

\*1 Mounting screws are available with code 1, 3 and 93. To order mounting screws separately, see page 59 for part numbers.

#### STEP 9 - SPECIAL OPTIONS

-338.0 - Sequential mating. Position 3 first mate, last break. Available on 3, 4, and 93 only.

CONTACT TECHNICAL SALES FOR SPECIAL OPTIONS

#### STEP 8 - ENVIRONMENTAL COMPLIANCE OPTIONS

/AA - RoHS Compliant)

**NOTE:** If compliance to environmental legislation is not required, this step will not be used. Example: PLB3W3F300A1

#### STEP 7 - CONTACT PLATING FOR PRINTED BOARD CONNECTORS

- 0 - Crimp Contacts ordered separately, see pages 47-53.
- A1 - Gold flash over nickel on mating end and termination end.
- A2 - Gold flash over nickel on mating end and 0.00020 inch [5.00µ] tin-lead solder coat on termination end. Not available with contact code 71 or 93.
- C1 - 0.000030 inch [0.76µ] gold over nickel on mating end and termination end.
- C2 - 0.000030 inch [0.76µ] gold over nickel on mating end and 0.00020 inch [5.00µ] tin-lead solder coated termination end. Not available with contact code 71 or 93.
- D1 - 0.000050 inch [1.27µ] gold over nickel on mating end and termination end.
- D2 - 0.000050 inch [1.27µ] gold over nickel on mating end and 0.00020 inch [5.00µ] tin-lead solder coated termination end. Not available with contact code 71 or 93.

#### STEP 6 - CABLE ADAPTER AND BLIND MATE SYSTEM

- 0 - None.
- 5 - Top Opening Hood.
- 11 - Blind Mating System for 0.040 [1.02] thick panel.
- 12 - Blind Mating System for 0.060 [1.52] thick panel.
- 13 - Blind Mating System for 0.090 [2.29] thick panel.
- 14 - Blind Mating System for 0.120 [3.05] thick panel.

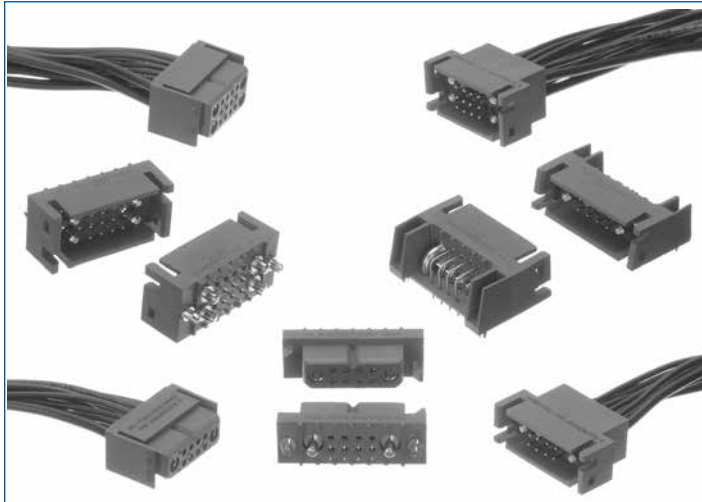

## PCS SERIES POWER CONNECTORS WITH MIXED DENSITY CONTACTS

### \* Mixed density contacts

- Power contacts have a resistance as low as 0.0003 ohms and carry up to 85 amperes per UL 1977
- Available with two power contacts and eight signal; or four power contacts and twelve signal
- Solder, press-in or cable terminations
- Integral locking on cable connectors

## TECHNICAL CHARACTERISTICS

### MATERIALS AND FINISHES:

<b>Insulator:</b>	Glass-filled polyester, UL 94V-0. Contact technical sales for availability of high temperature insulator material.
<b>Contacts:</b>	Precision machined copper alloy with gold flash over nickel, or 0.000030 inch [0.76 $\mu$ ] gold over nickel, or 0.000050 [1.27 $\mu$ ] gold over nickel. Solder coated terminations optional.
<b>Mounting Clip:</b>	Beryllium copper with tin plate.
<b>Hood:</b>	Glass filled polyester, UL 94V-0.
<b>Mounting Bracket:</b>	Brass with tin plate.
<b>Push-on Fastener:</b>	Spring tempered copper alloy, tin plate

### ELECTRICAL CHARACTERISTICS:

#### SIGNAL CONTACTS

<b>Contact Current Rating:</b>	7.5 amperes nominal.
<b>Initial Contact Resistance:</b>	0.007 ohms max. per IEC 60512-2, test 2b

#### POWER CONTACTS

<b>Contact Current Rating:</b>	See temperature rise curves on page 40. For additional information see pages 47-53.
<b>Initial Contact Resistance:</b>	0.0005 ohms max. per IEC 60512-2, test 2b.
<b>Standard Conductivity:</b>	0.0003 ohms max. per IEC 60512-2, test 2b.
<b>High Conductivity:</b>	0.0003 ohms max. per IEC 60512-2, test 2b.

#### SHIELDED CONTACTS

<b>Initial Contact Resistance:</b>	0.008 ohms maximum.
<b>Nominal Impedance:</b>	50 ohms.
<b>Insertion Loss:</b>	-0.46 dB at 1 GHz -1.5 dB at 2 GHz
<b>VSWR:</b>	1.15 average at 1 GHz 1.56 average at 2 GHz
Above values measured using frequency domain techniques.	
<b>Proof Voltage:</b>	1000 V r.m.s.

### ELECTRICAL CHARACTERISTICS, CONTINUED:

#### HIGH VOLTAGE CONTACTS

<b>Flash over Voltage:</b>	3600 V r.m.s.
<b>Proof Voltage:</b>	2700 V r.m.s.
<b>Initial Contact Resistance:</b>	0.008 ohms maximum.

#### CONNECTOR

<b>Insulation Resistance:</b>	5 G ohms per IEC 60512-2, test 3a, method A.
<b>Working Voltage:</b>	600 V rms.
<b>Voltage Proof:</b>	2200 V rms per IEC 60512-2, test 4a, method C.
<b>Clearance and Creepage Distance:</b>	0.080 inch [2.03 mm]
<b>Working Temperature:</b>	-55°C to +125°C.

### MECHANICAL CHARACTERISTICS:

#### SIGNAL CONTACTS

<b>Removable:</b>	Insert contact to rear face of insulator, release from front face of insulator. Size 20 contacts, 0.040 inch [1.02 mm] diameter male contacts, closed entry design female contacts.
<b>Fixed:</b>	Straight solder, right angle (90°) solder and straight compliant press-in printed board mount terminations. Size 20 contacts, 0.040 inch [1.02 mm] diameter male contacts, open entry design female contacts.

... continued on next page

CUL Recognized  
File # E49351



Positronic  
connectpositronic.com

# TECHNICAL INFORMATION AND TEMPERATURE RISE CURVES

Power  
Connection  
Systems

continued from previous page . . .

## MECHANICAL CHARACTERISTICS, CONTINUED:

### POWER CONTACTS:

**Removable:** Insert contact to rear face of insulator, release from front face of insulator. Size 8 contacts, 0.142 inch [3.61 mm] diameter male contacts, closed entry design female contacts.

**Printed Board Mount:** Straight solder, right angle (90°) solder and straight compliant press-in printed board mount terminations. Size 8 contacts, 0.142 inch [3.61 mm] male contacts, closed entry design female contacts.

### SHIELDED CONTACTS:

**Removable:** Insert contact to rear face of insulator, release from front face of insulator. Size 8 contacts. See page 53 table of cable sizes for contact termination dimensions.

### HIGH VOLTAGE CONTACTS:

**Removable:** Insert contact to rear face of insulator, release from front face of insulator. Size 8 contacts. Straight and right angle (90°) terminations. 0.041 inch [1.04 mm] minimum hole diameter.

**Contact Terminations:** 20-24 AWG [0.5-0.25mm<sup>2</sup>] removable crimp signal, 0.028 inch [0.71 mm] diameter straight and right angle (90°) solder printed board mount,

8-16 AWG [10.0-1.0mm<sup>2</sup>] removable solder and crimp power, 0.125 inch [3.18 mm] diameter straight and right angle (90°) solder printed board mount, power, shielded, high voltage cable, and straight compliant press-in terminations.

**Contact Retention in Insulator:**

Fixed signal - 9 lbs. [40 N].  
Removable Signal - 10 lbs. [44N].  
Power, shielded and high voltage - 22 lbs. [98 N].

**Resistance to Solder Iron Heat:**

500° F [260° C] for 10 second duration per IEC 60512-6, test 12e, 25 watt soldering iron.

**Connection Systems:**

Connector provides cable to cable, cable to printed board, cable to panel mount and printed board to printed board application.

**Locking System:**

Insulators provide locking between cable to cable, cable to printed board and cable to panel mount applications.

**Polarizations:**  
**Mounting to Printed Board:**

Provided in insulator design.  
Rapid installation push-on fasteners. Self-tapping screws for compliant connectors.

**Mechanical Operations:**

500 operations per IEC 60512-5.

## TEMPERATURE RISE CURVES

### STANDARD CONTACT MATERIAL

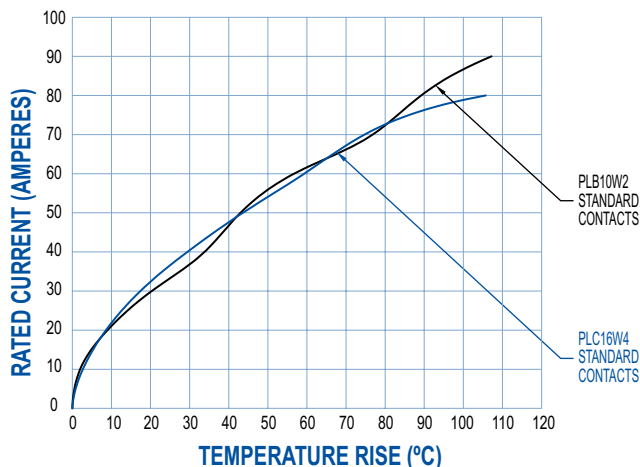

Test conducted in accordance with UL1977.  
All power contacts under load.

- 10W2:** Curve developed using PLB10W2F9300A1 and PLB10W2M0000 connectors with MC4008D contacts terminated to 8 AWG wire .
- 16W4:** Curve developed using PLC16W4F9300A1 and PLC16W4M0000 connectors with MC4008D contacts terminated to 8 AWG wire.

### HIGH CONDUCTIVITY CONTACT MATERIAL

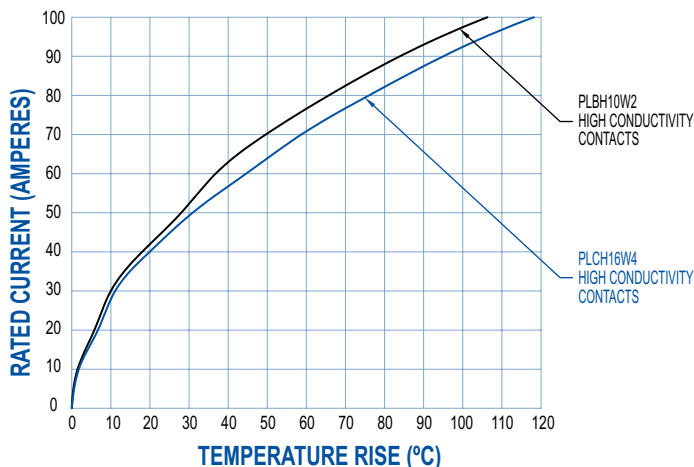

Test conducted in accordance with UL1977.  
All power contacts under load.

- 10W2:** Curve developed using PLBH10W2F9300A1 and PLB10W2M0000 connectors with MC4008DS contacts terminated to 8 AWG wire .
- 16W4:** Curve developed using PLCH16W4F9300A1 and PLC16W4M0000 connectors with MC4008DS contacts terminated to 8 AWG wire.

**PLB10W2 CABLE CONNECTOR**  
**FOR USE WITH SIZE 20 AND SIZE 8 REMOVABLE CONTACTS**  
**CODE 0**

CONTACTS ARE NOT SUPPLIED WITH CONNECTOR AND MUST BE ORDERED SEPARATELY

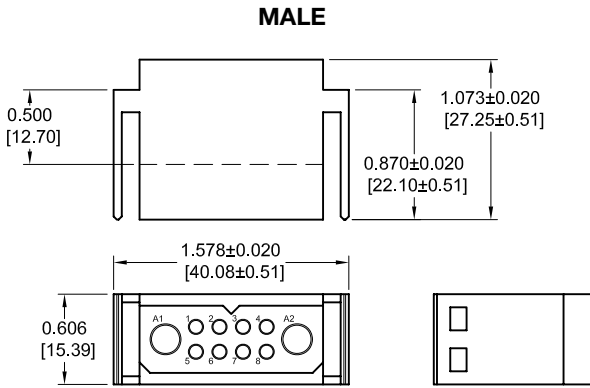

**Part Number:**  
**PLB10W2M0000**

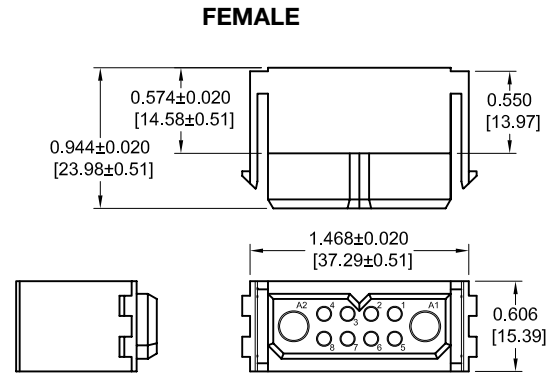

**Part Number:**  
**PLB10W2F0000**

**PLC16W4 CABLE CONNECTOR**  
**FOR USE WITH SIZE 20 AND SIZE 8 REMOVABLE CONTACTS**  
**CODE 0**

CONTACTS ARE NOT SUPPLIED WITH CONNECTOR AND MUST BE ORDERED SEPARATELY

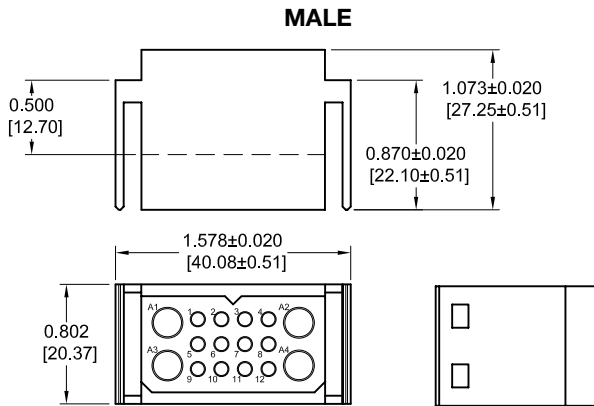

**Part Number:**  
**PLC16W4M0000**

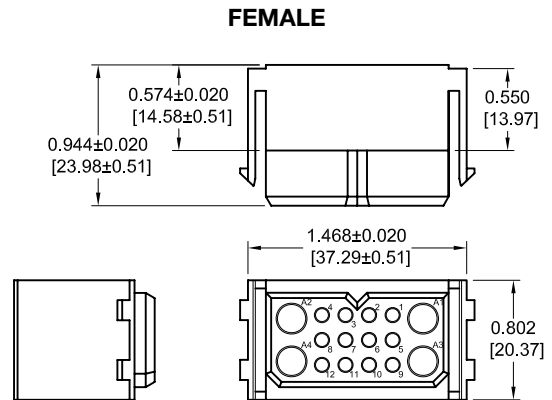

**Part Number:**  
**PLC16W4F0000**

*For information regarding size 20 and size 8 removable contacts, see Removable Contact section, pages 47-53.*



Positronic  
connectpositronic.com

# PANEL MOUNT CONNECTOR

Power  
Connection  
Systems

## PLB10W2 PANEL MOUNT CONNECTOR FOR USE WITH SIZE 20 AND SIZE 8 REMOVABLE CONTACTS CODE 1

CONTACTS ARE NOT SUPPLIED WITH CONNECTOR AND MUST BE ORDERED SEPARATELY

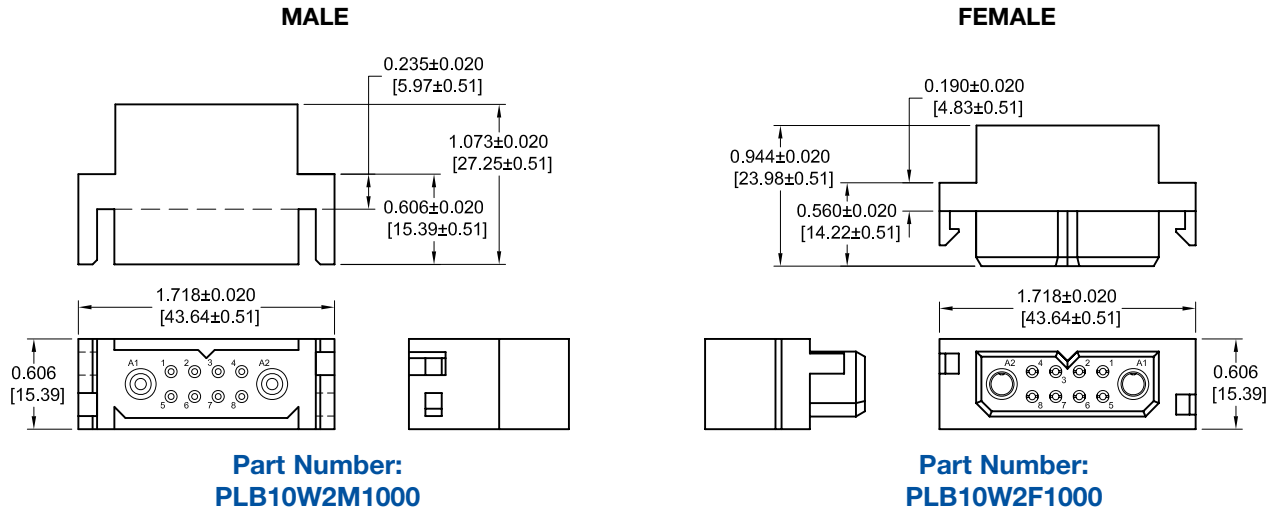

For panel cutout, see chart on page 63.

**NOTE:** MOUNTING SCREWS CAN BE SUPPLIED WITH CONNECTORS USING STEP 5 IN ORDERING INFORMATION ON PAGE 46. MOUNTING SCREWS CAN ALSO BE ORDERED SEPARATELY BY PART NUMBER. SEE PAGE 59.

## PLC16W4 PANEL MOUNT CONNECTOR FOR USE WITH SIZE 20 AND SIZE 8 REMOVABLE CONTACTS CODE 1

CONTACTS ARE NOT SUPPLIED WITH CONNECTOR AND MUST BE ORDERED SEPARATELY

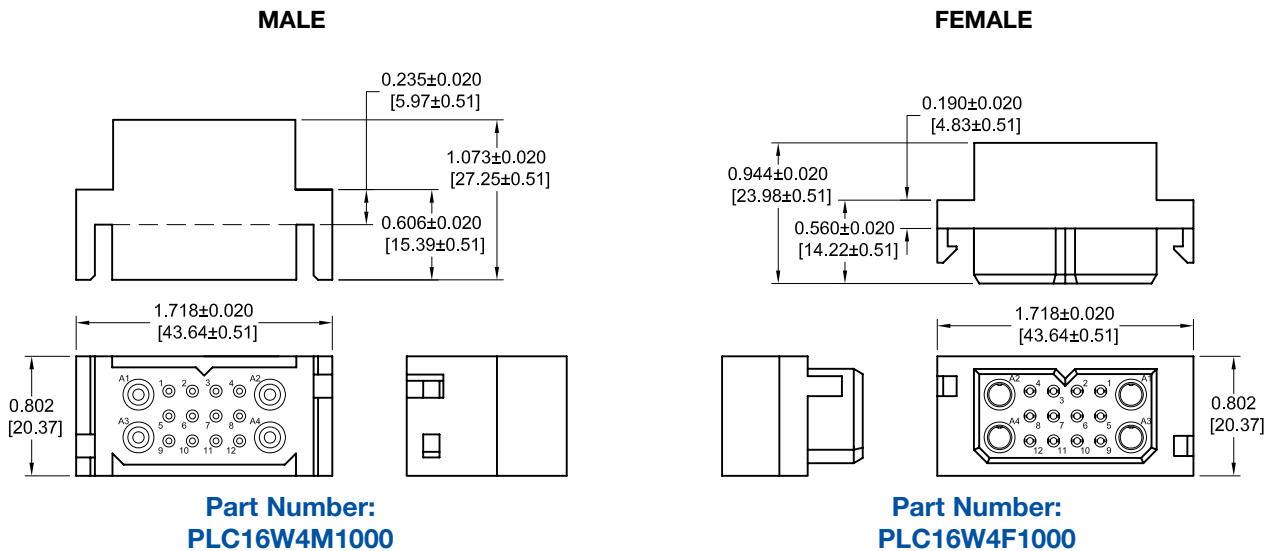

For panel cutout, see chart on page 63

**NOTE:** MOUNTING SCREWS CAN BE SUPPLIED WITH CONNECTORS USING STEP 5 IN ORDERING INFORMATION ON PAGE 46. MOUNTING SCREWS CAN ALSO BE ORDERED SEPARATELY BY PART NUMBER. SEE PAGE 59.

For information regarding size 20 and size 8 removable contacts, see Removable Contact section, pages 47-53.



## PLB(H)10W2 STRAIGHT PRINTED BOARD MOUNT CONNECTOR CODE 3, 0.146 [3.71] CONTACT EXTENSION

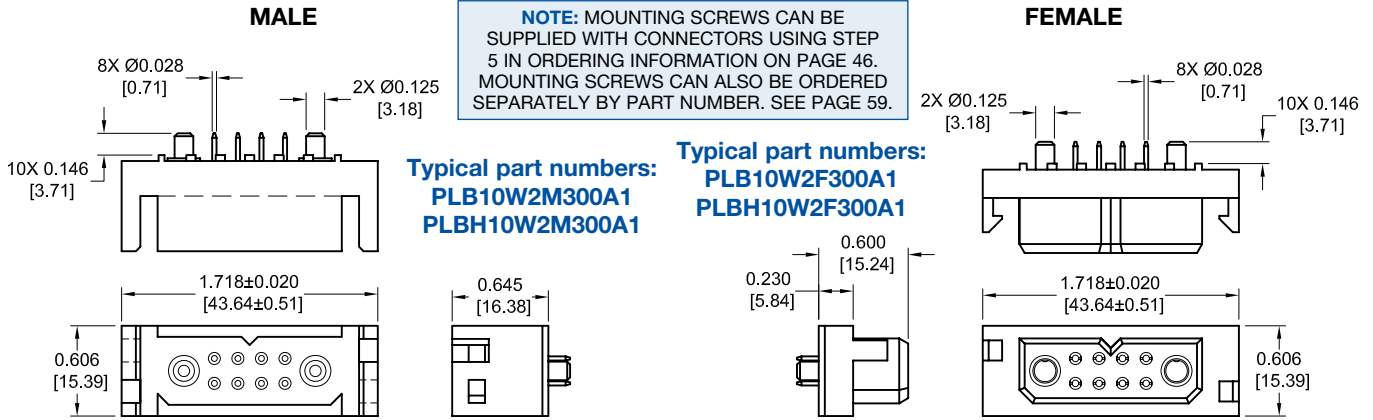

## PLC(H)16W4 STRAIGHT PRINTED BOARD MOUNT CONNECTOR CODE 3, 0.146 [3.71] CONTACT EXTENSION

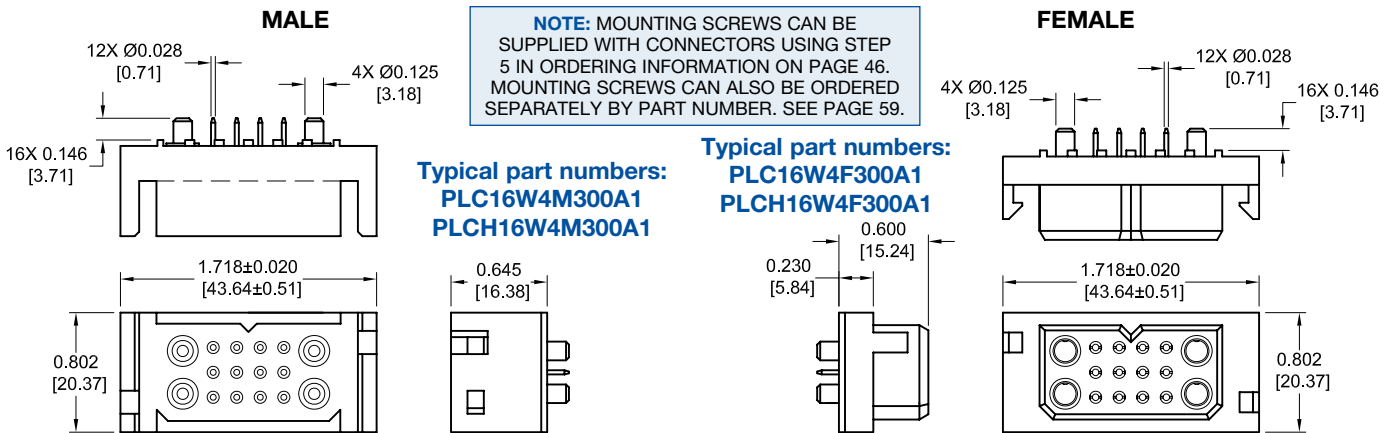

## STRAIGHT SOLDER AND COMPLIANT CONTACT HOLE PATTERN

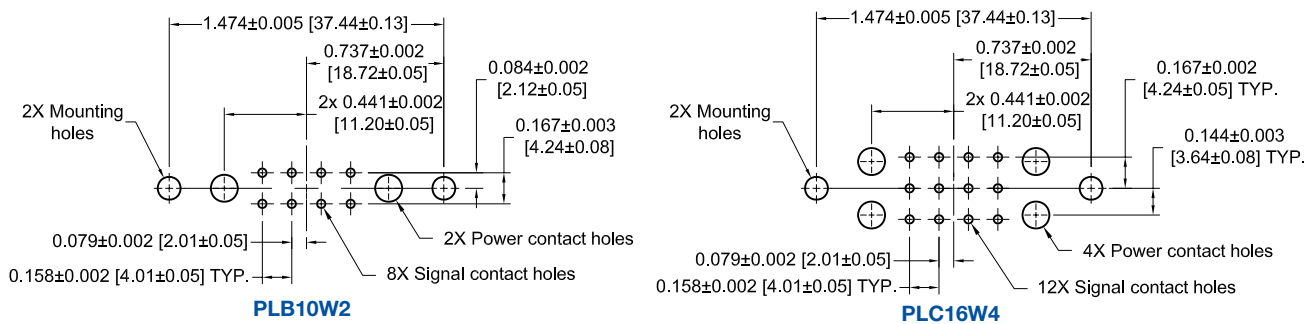

### SUGGESTED PRINTED BOARD HOLE SIZES:

- Suggest 0.145 [3.68] Ø hole in printed board for power contact termination positions.
  - Suggest 0.045 [1.14] Ø hole for signal solder contact termination positions.
  - Suggest 0.100 [2.54] Ø hole in printed board when mounting connectors with #2 thread forming screws.
  - Suggest 0.123±0.003 [3.12±0.08] Ø hole in printed board for mounting connector with push-on fasteners.
- NOTE:** See page 57 for suggested printed board drill hole sizes, recommended plating and finished hole sizes for compliant contact termination positions.



Positronic  
connectpositronic.com

# RIGHT ANGLE (90°) PRINTED BOARD CONNECTOR AND CONTACT HOLE PATTERN

Power  
Connection  
Systems

## PLB(H)10W2 RIGHT ANGLE (90°) PRINTED BOARD MOUNT CONNECTOR CODE 4, 0.146 [3.71] CONTACT EXTENSION

**NOTE:**  
MOUNTING  
SCREWS CAN  
BE ORDERED  
SEPARATELY  
BY PART  
NUMBER  
WHEN  
CHOOSING B3  
BRACKETS.  
SEE PAGE 59.

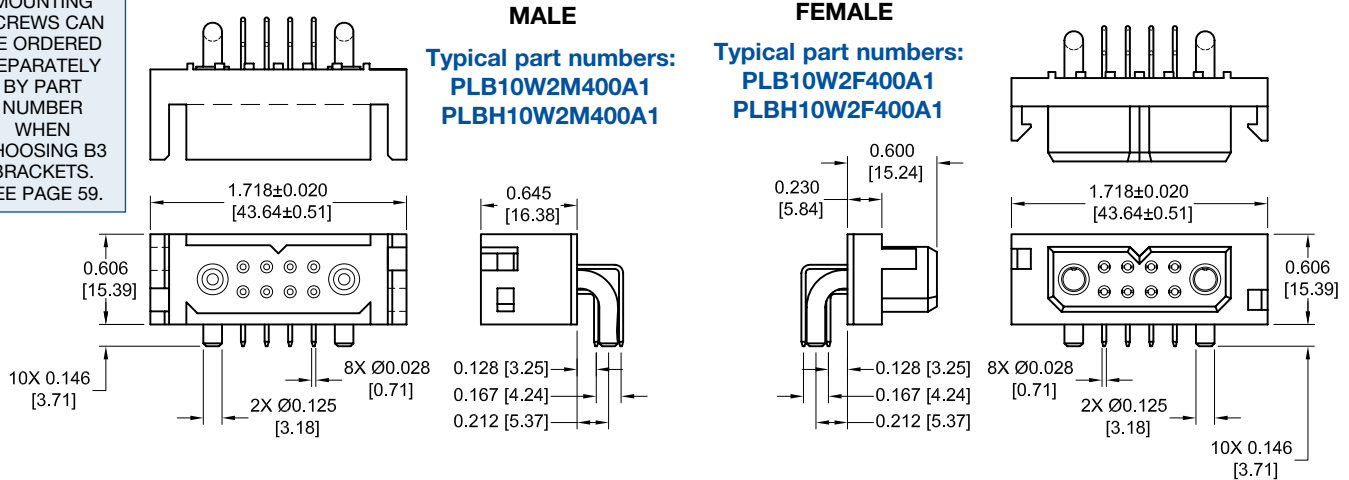

## PLC(H)16W4 RIGHT ANGLE (90°) PRINTED BOARD MOUNT CONNECTOR CODE 4, 0.146 [3.71] CONTACT EXTENSION

**NOTE:**  
MOUNTING  
SCREWS CAN  
BE ORDERED  
SEPARATELY  
BY PART  
NUMBER  
WHEN  
CHOOSING B3  
BRACKETS.  
SEE PAGE 59.

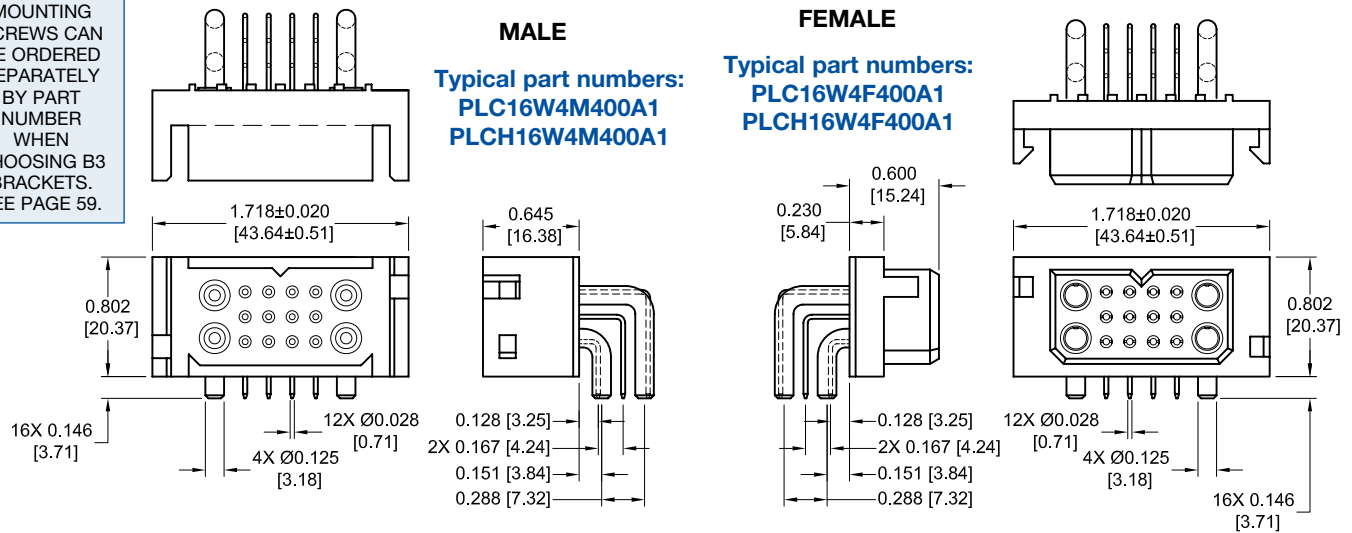

## RIGHT ANGLE (90°) PRINTED BOARD MOUNT CONTACT HOLE PATTERN

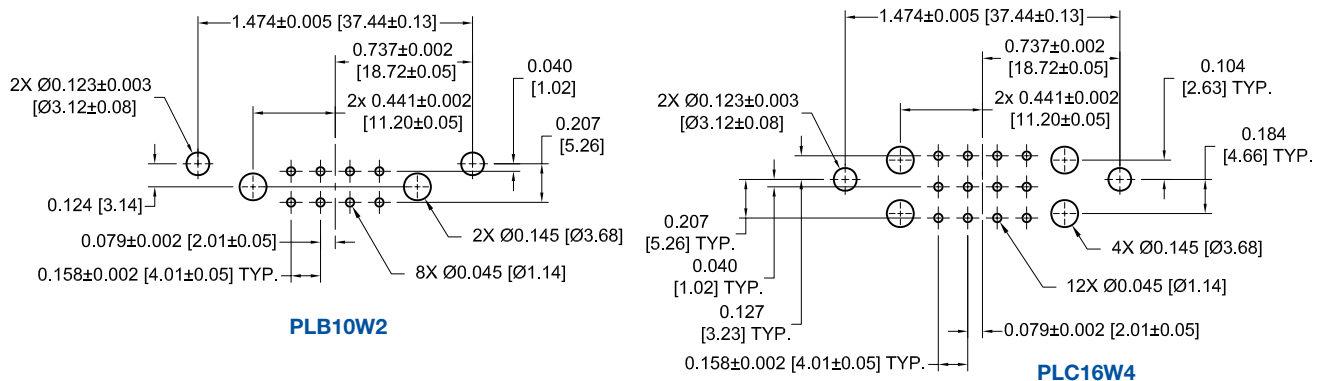

PLB(H)10W2 COMPLIANT PRESS-IN CONNECTOR  
CODE 93

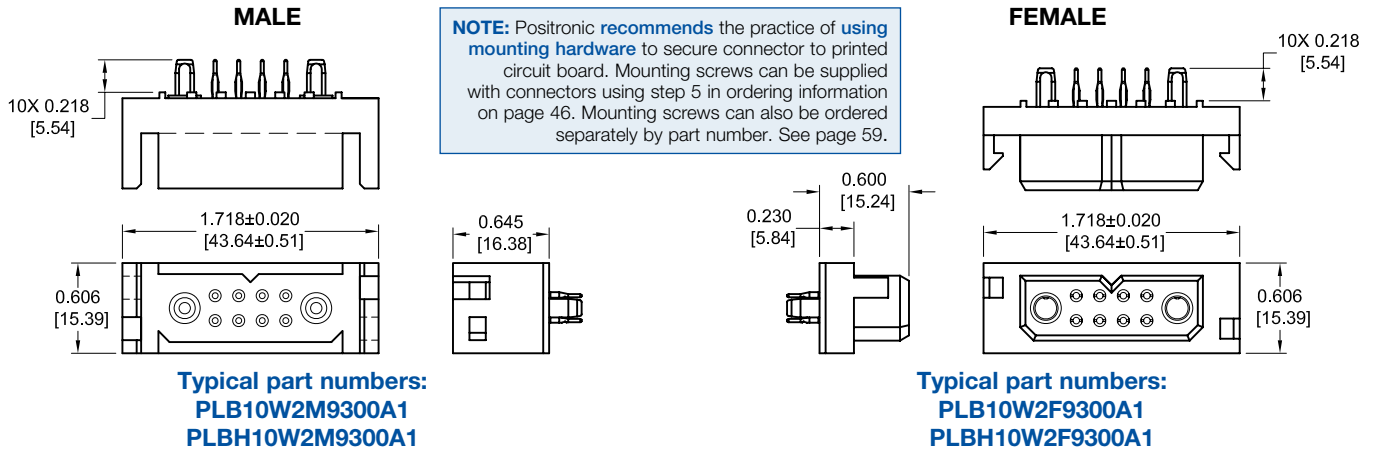

**NOTE:** Connectors are designed to be mounted to the printed circuit board with screws, see page 59 for mounting screw information. See page 43 for contact hole pattern.

PLC(H)16W4 COMPLIANT PRESS-IN CONNECTOR  
CODE 93

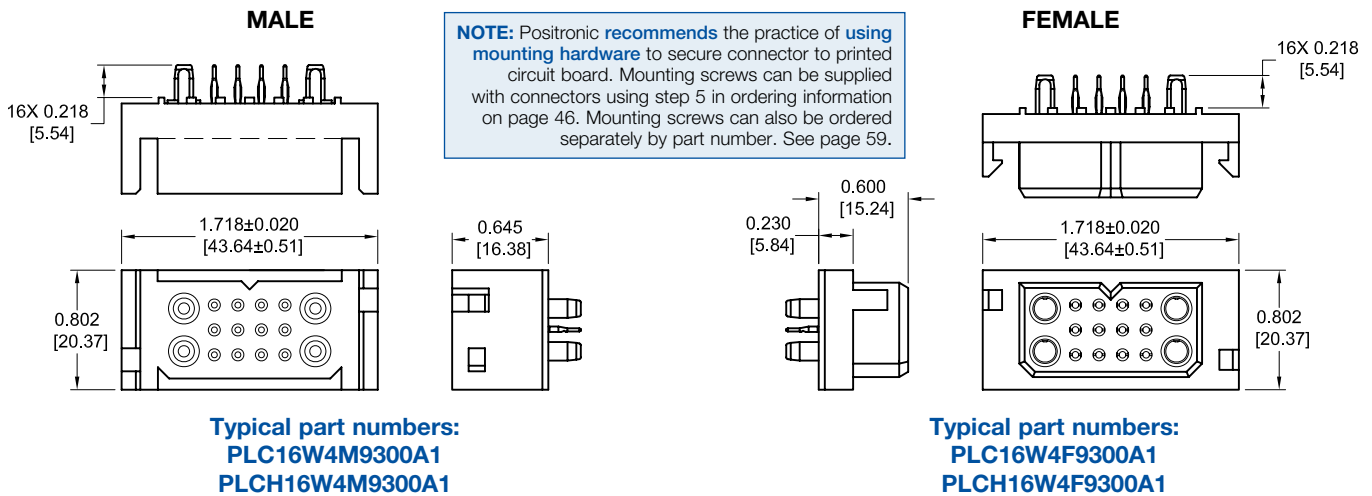

**NOTE:** Connectors are designed to be mounted to the printed circuit board with screws, see page 59 for mounting screw information. See page 43 for contact hole pattern.



## ORDERING INFORMATION - CODE NUMBERING SYSTEM

Specify Complete Connector By Selecting An Option From Step 1 Through 7

STEP	1	2	3	4	5	6	7	8	9
EXAMPLE	PLC	16W4	F	4	B3N	0	A1	/AA	

### STEP 1 - BASIC SERIES

- PLB - 2 Row
- PLBH - 2 Row High conductivity contacts
- PLC - 3 Row
- PLCH - 3 Row High conductivity contacts

### STEP 2 - CONNECTOR VARIANTS

- 2 Row - 10W2
- 3 Row - 16W4

### STEP 3 - CONNECTOR GENDER

- M - Male
- F - Female

### STEP 4 - CONTACT TERMINATION TYPE

- 0 - Removable contact, cable connector. Order contacts separately, see pages 47-53.
- \*1 - Removable contact, panel mounted connector. Order contacts separately, see pages 47-53.
- \*13 - Solder, Straight Printed Board Mount with 0.146 [3.71] tail extension.
- 4 - Solder, Right Angle (90°) Printed Board Mount with 0.146 [3.71] tail extension.
- \*193 - Straight Printed Board Mount, Press-in, length 0.218 [5.54] for 0.125 inch [3.18] thick board.

### STEP 5 - MOUNTING STYLE

- 0 - None.
- B - Metal Right Angle (90°) Mounting Bracket.
- BN - Metal Right Angle (90°) Mounting Bracket with Push-on Fastener.
- B3 - Plastic Right Angle (90°) Mounting Bracket with Cross Bar.
- B3N - Plastic Right Angle (90°) Mounting Bracket with Cross Bar and Push-on Fastener.
- N - Push-On Fastener For Straight Printed Board Mount Connectors
- ST2 - Self-tapping steel screws 2-28 x 0.250+0.030 [6.35+0.76] length for 0.093 [2.36] thick board.
- ST3 - Self-tapping steel screws 2-28 x 0.312+0.030 [7.92+0.76] length for 0.125 [3.18] thick board.
- ST4 - Self-tapping steel screws 2-28 x 0.375+0.030 [9.53+0.76] length for 0.175 [4.45] thick board.
- SS2 - Self-tapping stainless steel screws 2-28 x 0.250+0.030 [6.35+0.76] length for 0.093 [2.36] thick board.
- SS3 - Self-tapping stainless steel screws 2-28 x 0.312+0.030 [7.92+0.76] length for 0.125 [3.18] thick board.
- SS4 - Self-tapping stainless steel screws 2-28 x 0.375+0.030 [9.53+0.76] length for 0.175 [4.45] thick board.

### STEP 9 - SPECIAL OPTIONS

CONTACT TECHNICAL SALES  
FOR SPECIAL OPTIONS

### STEP 8 - ENVIRONMENTAL COMPLIANCE OPTIONS

/AA - RoHS Compliant

**NOTE:** If compliance to environmental legislation is not required, this step will not be used.  
Example: PLC16W4F4B3N0A1

### STEP 7 - CONTACT PLATING FOR PRINTED BOARD CONNECTORS

- 0 - Crimp Contacts ordered separately, see page 47-53.
- A1 - Gold flash over nickel on mating end and termination end.
- A2 - Gold flash over nickel on mating end and 0.00020 inch [5.00µ] tin-lead solder coat on termination end. Not available with code 93 in step 4.
- C1 - 0.000030 inch [0.76µ] gold over nickel on mating end and termination end.
- C2 - 0.000030 inch [0.76µ] gold over nickel on mating end and 0.00020 inch [5.00µ] tin-lead solder coated termination end. Not available with code 93 in step 4.
- D1 - 0.000050 inch [1.27µ] gold over nickel on mating end and termination end.
- D2 - 0.000050 inch [1.27µ] gold over nickel on mating end and 0.00020 inch [5.00µ] tin-lead solder coated termination end. Not available with code 93 in step 4.

### STEP 6 - HOODS AND PANEL MOUNT

- 0 - None.
- 51 - Top Opening Hood.
- 6 - Panel Mount, quick release.
- 81 - Panel Mount, fixed for 0.040 [1.02] thick panel.
- 82 - Panel Mount, fixed for 0.060 [1.52] thick panel.
- 83 - Panel Mount, fixed for 0.090 [2.29] thick panel.
- 11 - Blind Mating System for 0.040 [1.02] thick panel.
- 12 - Blind Mating System for 0.060 [1.52] thick panel.
- 13 - Blind Mating System for 0.090 [2.29] thick panel.
- 14 - Blind Mating System for 0.120 [3.05] thick panel..

\*1 Mounting screws are available with code 1, 3 and 93. To order mounting screws separately, see page 59 for part numbers.



## REMOVABLE CONTACT TECHNICAL CHARACTERISTICS

### SIZE 20 REMOVABLE CONTACT

#### MATERIALS AND FINISHES:

**STANDARD:** Precision machined copper alloy with gold flash over nickel. Other finishes are available, see optional plating finishes for -14 and -15.

#### MECHANICAL CHARACTERISTICS:

**STANDARD:** Insert contact to rear face of insulator, release from front face of insulator. Size 20 contacts, 0.040 inch [1.02 mm] diameter male contacts, closed entry design female contacts.

#### ELECTRICAL CHARACTERISTICS:

**Contact Current Rating:** 7.5 amperes nominal.  
**Initial Contact Resistance:** 0.007 ohms max. per IEC 60512-2, test 2b.

### SIZE 16 REMOVABLE CONTACT

#### MATERIALS AND FINISHES:

**STANDARD:** Precision machined copper alloy with gold flash over nickel. Other finishes are available, see optional plating finishes for -14 and -15.

**HIGH CONDUCTIVITY:** Tellurium copper, gold flash over nickel. Other finishes are available, see optional plating finishes for -14 and -15.

#### SHIELDED:

**Dielectric Material:** PCTFE  
**Inner Contacts:** Phosphor bronze, 0.000030 inch [0.76 $\mu$ ] gold over nickel. Other finishes are available, see optional plating finishes for -15.  
**Outer Contacts:** Brass and beryllium copper, gold flash over nickel. Other finishes are available, see optional plating finishes for -14.

#### MECHANICAL CHARACTERISTICS:

**STANDARD AND HIGH CONDUCTIVITY:** Insert contact to rear face of insulator, release from front face of insulator. Size 16 contacts, 0.0625 inch [1.588 mm] diameter male contacts. Female contact closed entry for highest reliability.

#### SHIELDED:

**Contact Retention In Insulator:** 18 lbs. [80N].  
**Removable Contacts:** Rear insertion, front removable.  
**Insertion Force Per Contact:** 8 oz. [2.2N] per contact maximum  
**Durability:** 100 cycles minimum.  
**Vibration:** 20g from 10 Hz to 500 Hz  
**Shock:** 30g - 11 ms

#### ELECTRICAL CHARACTERISTICS:

**STANDARD:**  
**Contact Current Rating:** See page 9 for detail information.  
**Initial Contact Resistance:** 0.0016 ohms max. per IEC 60512-2, test 2b.

#### HIGH CONDUCTIVITY:

**Contact Current Rating:** See page 9 for detail information.  
**Initial Contact Resistance:** 0.0007 ohms max. per IEC 60512-2, test 2b.

#### SHIELDED:

**Dielectric Strength At Sea Level:** 600 V rms  
**Initial Contact Resistance:** 0.012 ohms maximum  
**Insulation Resistance:** 5 G ohms  
**Insertion Loss:** 0.2 dB at 500 MHz for 126N contacts  
1.0 dB at 500 MHz for 226N contacts  
**VSWR:** 170 at 0 to 200 MHz  
2.25 at 200 to 500 MHz

### SIZE 12 REMOVABLE CONTACT

#### MATERIALS AND FINISHES:

**STANDARD:** Precision machined copper alloy with gold flash over nickel. Other finishes are available, see optional plating finishes for -14 and -15.

**HIGH CONDUCTIVITY:** Tellurium copper, gold flash over nickel. Other finishes are available, see optional plating finishes for -14 and -15.

#### MECHANICAL CHARACTERISTICS:

**STANDARD AND HIGH CONDUCTIVITY:** Insert contact to rear face of insulator, release from front face of insulator. Size 12 contacts, 0.094 inch [2.39 mm] diameter male contacts. Female contact closed entry for highest reliability.

#### ELECTRICAL CHARACTERISTICS:

**STANDARD:**  
**Contact Current Rating:** 40 amperes continuous, derated per IEC 60512-3, test 5b.  
**Initial Contact Resistance:** 0.001 ohms max. per IEC 60512-2, test 2b.  
**HIGH CONDUCTIVITY:**  
**Contact Current Rating:** See page 33 for detail information.  
**Initial Contact Resistance:** 0.0007 ohms max. per IEC 60512-2, test 2b.

### SIZE 8 REMOVABLE CONTACT

#### MATERIALS AND FINISHES:

**STANDARD:** Precision machined copper alloy with gold flash over nickel. Other finishes are available, see optional plating finishes for -14 and -15.

**HIGH CONDUCTIVITY:** Tellurium copper, gold flash over nickel. Other finishes are available, see optional plating finishes for -14 and -15.

#### HIGH VOLTAGE:

**Insulator Material:** PTFE teflon  
**Contacts:** Male contacts, brass. Female contacts, phosphor bronze. Male and female contacts, 0.000030 inch [0.76 $\mu$ ] gold over nickel. Other finishes are available, see optional plating finishes for -15.

#### SHIELDED:

**Dielectric Material:** PTFE teflon  
**Inner Contacts:** Phosphor bronze, 0.000030 inch [0.76 $\mu$ ] gold over nickel. Other finishes are available, see optional plating finishes for -15.  
**Outer Contacts:** Brass and beryllium copper, gold flash over nickel. Other finishes are available, see optional plating finishes for -14.

... continued on next page

For information regarding **CRIMP TOOLS & CRIMPING TOOL TECHNIQUES**, see page 54.



### REMOVABLE CONTACT TECHNICAL CHARACTERISTICS

continued from previous page . . .

#### MECHANICAL CHARACTERISTICS:

**STANDARD AND HIGH CONDUCTIVITY:** Insert contact to rear face of insulator, release from front face of insulator. Size 8 contacts, 0.142 inch [3.61 mm] diameter male contacts, closed entry design female contacts.

**HIGH VOLTAGE:** Insert contact to rear face of insulator, release from front face of insulator. Size 8 contacts. Straight and right angle (90°) terminations. 0.041 inch [1.04 mm] minimum hole diameter.

**Durability:** 500 cycles minimum.

**Vibration:** 20g from 10 Hz to 500 Hz.

**Shock:** 30g-11ms.

**SHIELDED:** Insert contact to rear face of insulator, release from front face of insulator. Size 8 contacts. See page 53 table of cable sizes for contact Termination dimensions.

#### ELECTRICAL CHARACTERISTICS:

**STANDARD:**  
**Contact Current Rating:** See temperature rise curves on page 40. For additional information see page 51-52.  
**Initial Contact Resistance:** 0.001 ohms max. per IEC 60512-2, test 2b.

**HIGH CONDUCTIVITY:**  
**Contact Current Rating:** See temperature rise curves on page 40.  
**Initial Contact Resistance:** 0.0003 ohms max. per IEC 60512-2, test 2b.

#### HIGH VOLTAGE:

**Flash over Voltage:** 3600 V r.m.s.  
**Proof Voltage:** 2700 V r.m.s.  
**Initial Contact Resistance:** 0.008 ohms maximum.

#### SHIELDED:

**Initial Contact Resistance:** 0.008 ohms maximum.  
**Nominal Impedance:** 50 ohms.  
**Insertion Loss:** -0.46 dB at 1 GHz  
-1.5 dB at 2 GHz  
**VSWR:** 1.15 average at 1 GHz  
1.56 average at 2 GHz  
Above values measured using frequency domain techniques.  
**Proof Voltage:** 1000 V r.m.s.

#### OPTIONAL PLATING FINISHES

- 14 0.000030 [0.76 μ] gold over nickel by adding "-14" suffix onto part number. Example: FC720N2-14.
- 15 0.000050 inch [1.27 μ] gold over nickel by adding "-15". Example: FC720N2-15.

#### RoHS OPTIONS:

/AA Environmental Compliance Option: RoHS compliant can be achieved by adding "/AA" suffix onto part number. Examples: FC720N2/AA or for optional plating finishes use FC720N2/AA-14.

REMOVABLE CONTACT

### REMOVABLE CRIMP SIGNAL CONTACT FOR USE WITH PCS MIXED DENSITY SERIES CONNECTORS CONTACTS MUST BE ORDERED SEPARATELY SIZE 20

FEMALE CONTACT

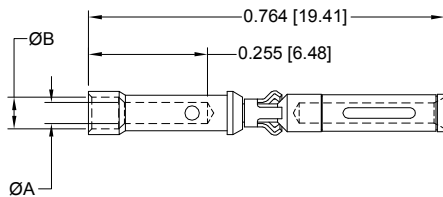

MALE CONTACT

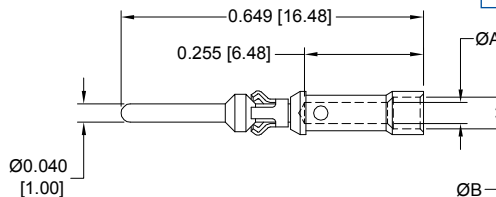

Note: Connectors can be kitted with all applicable crimp/solder contacts, contact Technical Sales for connector part number.

PART NUMBER	WIRE SIZE AWG/[mm²]	ØA	ØB
FC720N2	20 / 22 / 24 [0.5 / 0.3 / 0.25]	0.045 [1.14]	0.068 [1.73]

PART NUMBER	WIRE SIZE AWG/[mm²]	ØA	ØB
MC720N3	20 / 22 / 24 [0.5 / 0.3 / 0.25]	0.045 [1.14]	0.068 [1.73]

For information regarding **CRIMP TOOLS & CRIMPING TOOL TECHNIQUES**, see page 54.

See page 9 for current ratings.

## REMOVABLE CRIMP CONTACT FOR USE WITH PCS SERIES CONNECTORS CONTACTS MUST BE ORDERED SEPARATELY SIZE 16

Note: Connectors can be kitted with all applicable crimp/solder contacts, contact Technical Sales for connector part number.

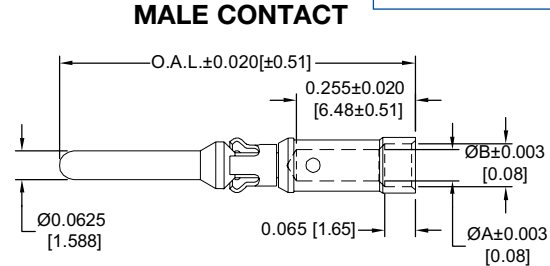
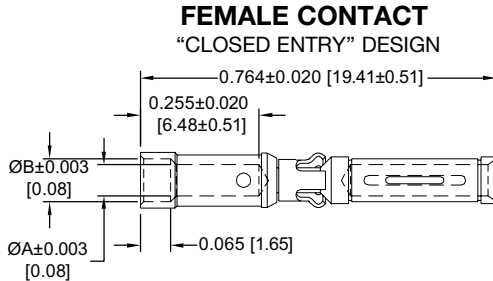

PART NUMBERS	WIRE SIZE AWG/[mm <sup>2</sup> ]	ØA	ØB
FC112N2	12 [4.0]	0.098 [2.49]	N/A
FC112N2S	12 [4.0]	0.098 [2.49]	N/A
FC114N2	14-16 [2.5-1.5]	0.081 [2.06]	0.105 [2.67]
FC116N2	16-18 [1.5-1.0]	0.067 [1.70]	0.093 [2.36]
FC120N2	20-22-24 [0.5-0.3-0.25]	0.045 [1.14]	0.068 [1.73]

"S" in part number indicates high conductivity material.  
Compatible with PL\*H PCB mount connectors. See ordering information.

PART NUMBERS	WIRE SIZE AWG/[mm <sup>2</sup> ]	ØA	ØB	OAL
MC112N	12 [4.0]	0.098 [2.49]	N/A	0.764 [19.41]
MC112NS	12 [4.0]	0.098 [2.49]	N/A	0.764 [19.41]
*MC112N-133.0	12 [4.0]	0.098 [2.49]	N/A	0.684 [17.37]
*MC112N-133.1	12 [4.0]	0.098 [2.49]	N/A	0.724 [18.39]
*MC112N-133.2	12 [4.0]	0.098 [2.49]	N/A	0.744 [18.90]
*MC112N-133.3	12 [4.0]	0.098 [2.49]	N/A	0.804 [20.42]
MC114N	14-16 [2.5-1.5]	0.081 [2.06]	0.105 [2.67]	0.764 [19.41]
MC116N	16-18 [1.5-1.0]	0.067 [1.70]	0.093 [2.36]	0.764 [19.41]
*MC116N-133.0	16-18 [1.5-1.0]	0.067 [1.70]	0.093 [2.36]	0.684 [17.37]
*MC116N-133.1	16-18 [1.5-1.0]	0.067 [1.70]	0.093 [2.36]	0.724 [18.39]
*MC116N-133.2	16-18 [1.5-1.0]	0.067 [1.70]	0.093 [2.36]	0.744 [18.90]
*MC116N-133.3	16-18 [1.5-1.0]	0.067 [1.70]	0.093 [2.36]	0.804 [20.42]
MC120N	20-22-24 [0.5-0.3-0.25]	0.045 [1.14]	0.068 [1.73]	0.764 [19.41]

\* indicates Sequential mate contacts, see page 25 for more information regarding Sequential Mating System.

See page 9 for current ratings.

## REMOVABLE SOLDER CUP CONTACT FOR USE WITH PCS SERIES CONNECTORS CONTACTS MUST BE ORDERED SEPARATELY SIZE 16

Note: Connectors can be kitted with all applicable crimp/solder contacts, contact Technical Sales for connector part number.

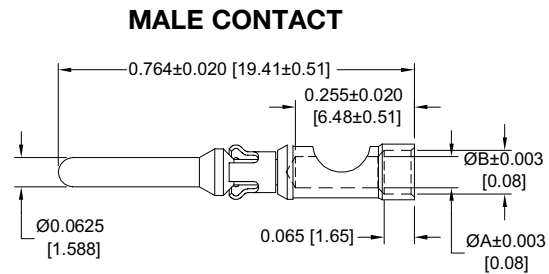
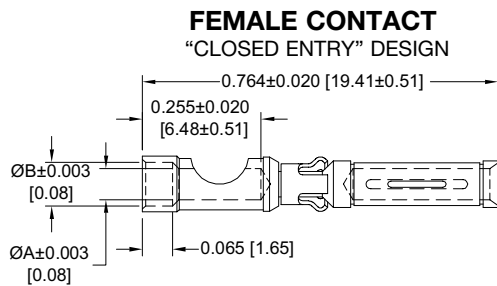

PART NUMBERS	WIRE SIZE AWG/[mm <sup>2</sup> ]	ØA	ØB
FS112N2	12 [4.0]	0.098 [2.49]	N/A
FS112N2S	12 [4.0]	0.098 [2.49]	N/A
FS114N2	14 [2.5]	0.081 [2.06]	0.105 [2.67]
FS116N2	16 [1.5]	0.067 [1.70]	0.093 [2.36]
FS120N2	20 [0.5]	0.045 [1.14]	0.068 [1.73]

"S" in part number indicates high conductivity material.  
Compatible with PL\*H PCB mount connectors. See ordering information.

PART NUMBERS	WIRE SIZE AWG/[mm <sup>2</sup> ]	ØA	ØB
MS112N	12 [4.0]	0.098 [2.49]	N/A
MS112NS	12 [4.0]	0.098 [2.49]	N/A
MS114N	14 [2.5]	0.081 [2.06]	0.105 [2.67]
MS116N	16 [1.5]	0.067 [1.70]	0.093 [2.36]
MS120N	20 [0.5]	0.045 [1.14]	0.068 [1.73]

For information regarding CRIMP TOOLS & CRIMPING TOOL TECHNIQUES, see page 54.



### REMOVABLE CRIMP SHIELDED CONTACT FOR USE WITH PCS SERIES CONNECTORS CONTACTS MUST BE ORDERED SEPARATELY SIZE 16

Note: Connectors can be kitted with all applicable crimp/solder contacts, contact Technical Sales for connector part number.

MALE CONTACT

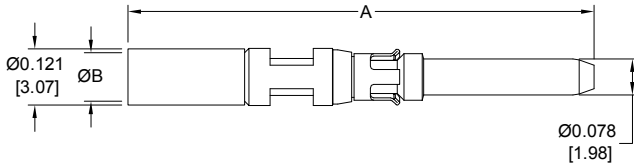

FEMALE CONTACT

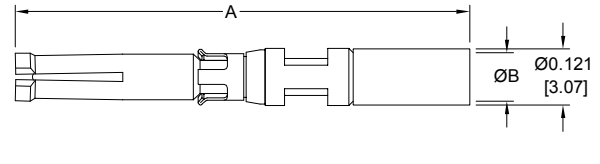

PART NUMBERS	CABLE SIZE	CHARACT. IMPED.	A	ØB
MCS126N	RG 178 B/U	50 ohms	0.993 [25.22]	0.045 [1.14]
	RG 196 B/U	50 ohms		
MCS226N	RG 179 B/U	75 ohms	1.022 [25.96]	0.070 [1.78]
	RG 316 /U	50 ohms		

PART NUMBERS	CABLE SIZE	CHARACT. IMPED.	A	ØB
FCS126N2	RG 178 B/U	50 ohms	0.967 [24.56]	0.045 [1.14]
	RG 196 B/U	50 ohms		
FCS226N2	RG 179 B/U	75 ohms	1.022 [25.96]	0.070 [1.78]
	RG 316 /U	50 ohms		

REMOVABLE CONTACT

### REMOVABLE CRIMP CONTACT

FOR USE WITH SHROUDED AND POWER INPUT CONNECTORS  
CONTACTS MUST BE ORDERED SEPARATELY  
SIZE 12

See page 33 for current ratings.

Note: Connectors can be kitted with all applicable crimp/solder contacts, contact Technical Sales for connector part number.

FEMALE CONTACT

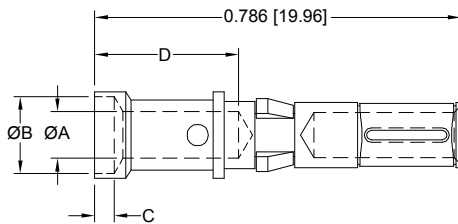

MALE CONTACT

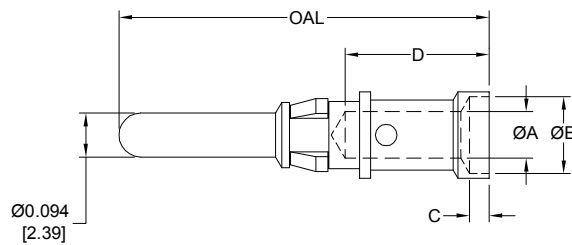

PART NUMBER	WIRE SIZE AWG/[mm <sup>2</sup> ]	ØA	ØB	C	D
FC610N2S	10 [6.0]	0.147 [3.73]	N/A	N/A	0.254 [6.45]
FC612N2	12 [4.0]	0.100 [2.54]	0.165 [4.19]	0.042 [1.06]	0.309 [7.85]

"S" in part number indicates high conductivity material.  
Compatible with PLBH3W3 or PLSH PCB mount connectors. See ordering information.

PART NUMBER	WIRE SIZE AWG/[mm <sup>2</sup> ]	ØA	ØB	C	D	OAL
MC610NS	10 [6.0]	0.147 [3.73]	N/A	N/A	0.254 [6.45]	0.795 [20.19]
MC610NS-228.2	10 [6.0]	0.147 [3.73]	N/A	N/A	0.254 [6.45]	0.714 [18.14]
MC612N	12 [4.0]	0.100 [2.54]	0.165 [4.19]	0.042 [1.06]	0.309 [7.85]	0.795 [20.19]
MC612N-228.2	12 [4.0]	0.100 [2.54]	0.165 [4.19]	0.042 [1.06]	0.309 [7.85]	0.714 [18.14]

For information regarding **CRIMP TOOLS & CRIMPING TOOL TECHNIQUES**, see page 54.





## REMOVABLE SOLDER CUP CONTACT

FOR USE WITH SHROUDED AND POWER INPUT CONNECTORS

CONTACTS MUST BE ORDERED SEPARATELY

SIZE 12

See page 33  
for current ratings.

Note: Connectors can be kitted with all applicable crimp/solder contacts, contact Technical Sales for connector part number.

### FEMALE CONTACT

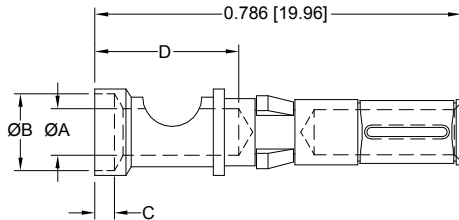

### MALE CONTACT

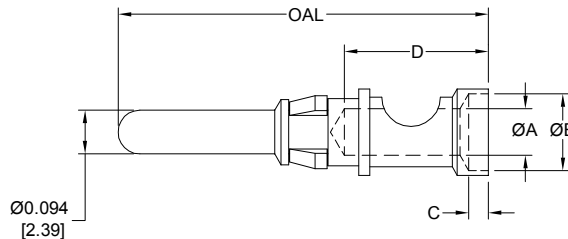

PART NUMBER	WIRE SIZE AWG/[mm <sup>2</sup> ]	ØA	ØB	C	D
FS610N2S	10 [6.0]	0.147 [3.73]	N/A	N/A	0.254 [6.45]
FS612N2	12 [4.0]	0.100 [2.54]	0.165 [4.19]	0.042 [1.06]	0.309 [7.85]

“S” in part number indicates high conductivity material.  
Compatible with PLBH3W3 or PLSH PCB mount connectors. See ordering information.

PART NUMBER	WIRE SIZE AWG/[mm <sup>2</sup> ]	ØA	ØB	C	D	OAL
MS610NS	10 [6.0]	0.147 [3.73]	N/A	N/A	0.254 [6.45]	0.795 [20.19]
MS610NS-228.2	10 [6.0]	0.147 [3.73]	N/A	N/A	0.254 [6.45]	0.714 [18.14]
MS612N	12 [4.0]	0.100 [2.54]	0.165 [4.19]	0.042 [1.06]	0.309 [7.85]	0.795 [20.19]
MS612N-228.2	12 [4.0]	0.100 [2.54]	0.165 [4.19]	0.042 [1.06]	0.309 [7.85]	0.714 [18.14]

REMOVABLE CONTACT

## REMOVABLE CRIMP CONTACT

FOR USE WITH PCS MIXED DENSITY SERIES CONNECTORS

CONTACTS MUST BE ORDERED SEPARATELY

SIZE 8

Note: Connectors can be kitted with all applicable crimp/solder contacts, contact Technical Sales for connector part number.

### \* FEMALE CONTACT CLOSED ENTRY, L.S.A.

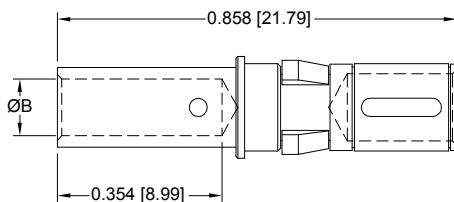

### MALE CONTACT

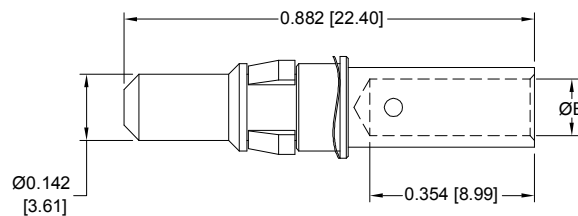

PART NUMBER	CURRENT RATING	WIRE SIZE AWG/[mm <sup>2</sup> ]	ØB
FC4008D	See Temp. Rise Curve, page 40.	8 / [10.0]	0.181 [4.60]
FC4008DS	See Temp. Rise Curve, page 40.	8 / [10.0]	0.181 [4.60]
FC4010D	30 amperes	10 / [6.0]	0.122 [3.10]
FC4012D	20 amperes	12 / [4.0]	0.101 [2.57]
FC4016D	10 amperes	16 / [1.5]	0.067 [1.70]

“S” in part number indicates high conductivity material.  
Compatible with PL\*H PCB mount connectors. See ordering information.

PART NUMBER	CURRENT RATING	WIRE SIZE AWG/[mm <sup>2</sup> ]	ØB
MC4008D	See Temp. Rise Curve, page 40.	8 / [10.0]	0.181 [4.60]
MC4008DS	See Temp. Rise Curve, page 40.	8 / [10.0]	0.181 [4.60]
MC4010D	30 amperes	10 / [6.0]	0.122 [3.10]
MC4012D	20 amperes	12 / [4.0]	0.101 [2.57]
MC4016D	10 amperes	16 / [1.5]	0.067 [1.70]

\*NOTE: Female contacts feature Large Surface Area (L.S.A.) closed entry contact design which provides maximum mating surfaces between male and female contact and reduced contact resistance during operation.

For information regarding **CRIMP TOOLS & CRIMPING TOOL TECHNIQUES**, see page 54.



# REMOVABLE HIGH VOLTAGE CONTACT SIZE 8

### REMOVABLE SOLDER CUP CONTACT FOR USE WITH PCS MIXED DENSITY SERIES CONNECTORS CONTACTS MUST BE ORDERED SEPARATELY SIZE 8

Note: Connectors can be kitted with all applicable crimp/solder contacts, contact Technical Sales for connector part number.

#### \* FEMALE CONTACT CLOSED ENTRY, L.S.A.

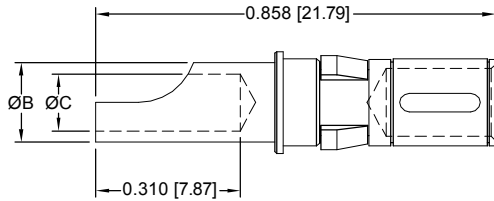

#### MALE CONTACT

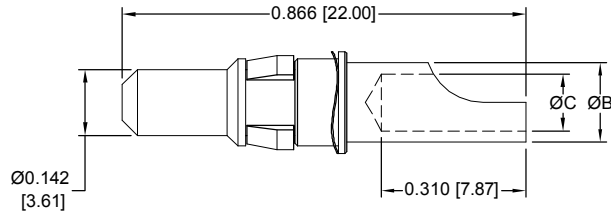

PART NUMBER	CURRENT RATING	WIRE SIZE AWG/[mm <sup>2</sup> ]	ØB	ØC
FS4008D	40 amperes	8 / [10.0]	0.219 [5.56]	0.182 [4.62]
FS4012D	20 amperes	12 / [4.0]	0.143 [3.63]	0.112 [2.84]
FS4016D	10 amperes	16 / [1.5]	0.100 [2.54]	0.069 [1.75]

PART NUMBER	CURRENT RATING	WIRE SIZE AWG/[mm <sup>2</sup> ]	ØB	ØC
MS4008D	40 amperes	8 / [10.0]	0.219 [5.56]	0.188 [4.78]
MS4012D	20 amperes	12 / [4.0]	0.143 [3.63]	0.112 [2.84]
MS4016D	10 amperes	16 / [1.5]	0.100 [2.54]	0.069 [1.75]

\*NOTE: Female contacts feature Large Surface Area (L.S.A.) closed entry contact design which provides maximum mating surfaces between male and female contact and reduced contact resistance during operation.

### REMOVABLE HIGH VOLTAGE CONTACT FOR USE WITH PCS MIXED DENSITY SERIES CONNECTORS CONTACTS MUST BE ORDERED SEPARATELY SIZE 8

Note: Connectors can be kitted with all applicable crimp/solder contacts, contact Technical Sales for connector part number.

#### STRAIGHT SOLDER WIRE TERMINATION

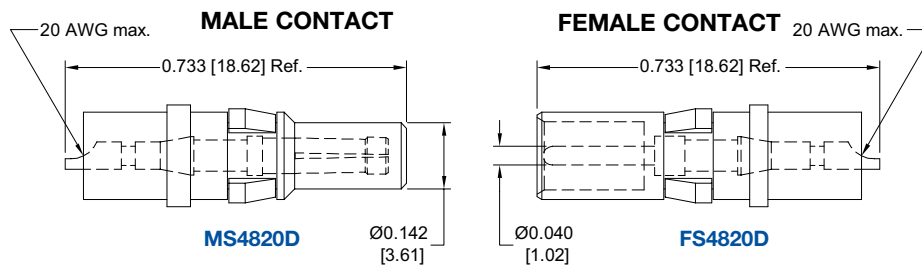

#### RIGHT ANGLE (90°) SOLDER WIRE TERMINATION

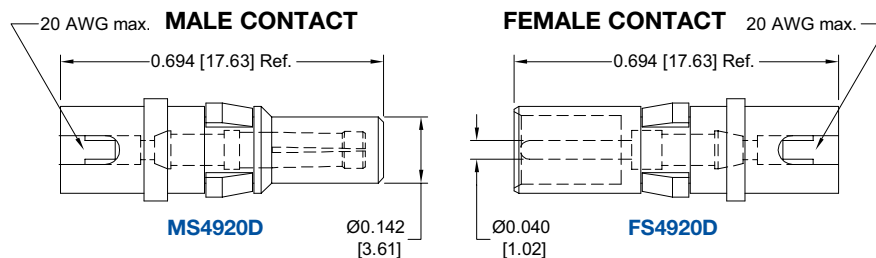

For information regarding **CRIMP TOOLS & CRIMPING TOOL TECHNIQUES**, see page 54.

REMOVABLE CONTACT

## REMOVABLE SHIELDED CONTACT FOR USE WITH PCS MIXED DENSITY SERIES CONNECTORS CONTACTS MUST BE ORDERED SEPARATELY SIZE 8

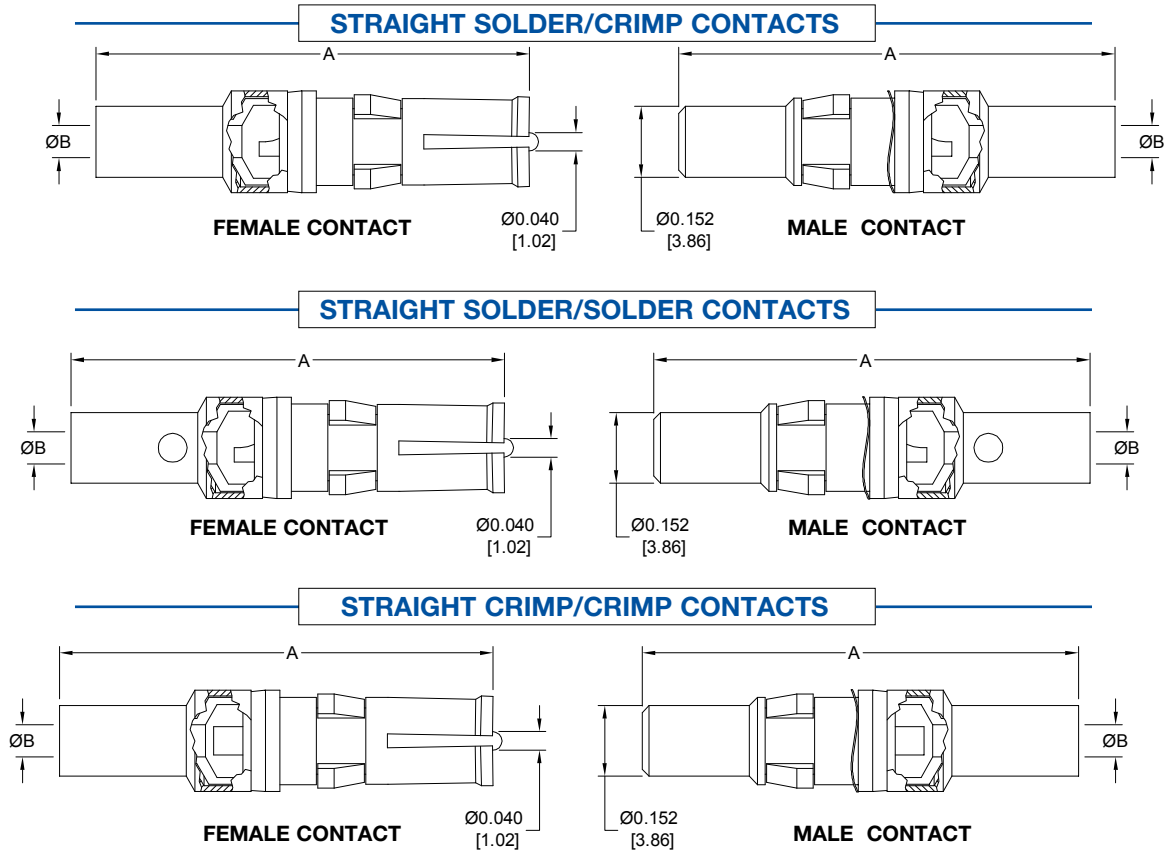

TYPE OF CONTACT	PART NUMBER		A	ØB	RG CABLE NUMBER
	MALE	FEMALE			
SOLDER/CRIMP	MC4101D	FC4101D	0.929 [23.60]	0.040 [1.02]	178 B/U 196 B/U
SOLDER/CRIMP	MC4102D	FC4102D	0.929 [23.60]	0.067 [1.70]	179 B/U 316 /U
SOLDER/CRIMP	MC4103D	FC4103D	1.037 [26.34]	0.108 [2.74]	180 B/U
SOLDER/CRIMP	MC4104D	FC4104D	1.037 [26.34]	0.120 [3.05]	58 B/U
SOLDER/SOLDER	MS4101D	FS4101D	0.929 [23.60]	0.040 [1.02]	178 B/U 196 B/U
SOLDER/SOLDER	MS4102D	FS4102D	0.929 [23.60]	0.067 [1.70]	179 B/U 316 /U
SOLDER/SOLDER	MS4103D	FS4103D	1.037 [26.34]	0.108 [2.74]	180 B/U
SOLDER/SOLDER	MS4104D	FS4104D	1.037 [26.34]	0.120 [3.05]	58 B/U
CRIMP/CRIMP	MCC4101D	FCC4101D	0.929 [23.60]	0.040 [1.02]	178 B/U 196 B/U
CRIMP/CRIMP	MCC4102D	FCC4102D	0.929 [23.60]	0.067 [1.70]	179 B/U 316 /U
CRIMP/CRIMP	MCC4103D	FCC4103D	1.037 [26.34]	0.108 [2.74]	180 B/U
CRIMP/CRIMP	MCC4104D	FCC4104D	1.037 [26.34]	0.120 [3.05]	58 B/U

Note: Connectors can be kitted with all applicable crimp / solder contacts, contact Technical Sales for connector part number.



### SHIELDED CONTACTS

Two-step crimping action for signal and shielding conductors.

For information regarding **CRIMP TOOLS & CRIMPING TOOL TECHNIQUES**, see page 54.



## APPLICATION TOOLS SECTION

PLA (H), PLB (H), PLC (H) and PLS (H) connectors are offered with

**removable crimp contacts**. Positronic recognizes the

**importance of** supplying **application tooling** to

support our customers' use of our products.

Information on application tooling is

**available** on our web site at

<http://www.connectpositronic.com/tooling>



There you will find **downloadable PDF** cross reference

charts for removable and compliant press-in contacts. These charts

will **supply part numbers** for insertion, removal and crimping tools,

along with **information regarding use** of tools and techniques.

## Connectors Designed To Customer Specifications

Positronic's **PLA(H), PLB(H), PLC(H) and PLS(H) series** connectors can be modified to customers specifications.

**Examples:** select loading of contacts for cost savings or to gain creepage and clearance distances; longer printed circuit board terminations; customer specified hardware.

*Positronic can develop and tool new connector designs with reasonable price and delivery.*

**Contact Technical Sales with your particular requirements.**



## CONTACT APPLICATION TOOLS CROSS REFERENCE LIST

USE INDICATED POSITRONIC TOOLS FOR BEST RESULTS

PCS MIXED DENSITY	SAFTEY SHROUD & POWER INPUT		P C S S E R I E S										
	SIZE 8 CONTACTS	SIZE 20	SIZE 16 CONTACTS										
*C4101D	9504-14-0-0	9504-1-0-0	HX4	M22520/5-01	9504-14-1-0	Y878	N/A	4311-0-0-0	P+				
*C4102D	9504-13-0-0	9504-1-0-0	HX4	M22520/5-01	9504-13-1-0	Y937	N/A	4311-0-0-0	P+				
*C4103D	9504-15-0-0	9504-1-0-0	HX4	M22520/5-01	9504-15-1-0	Y877	N/A	4311-0-0-0	P+				
*C4104D	9504-15-0-0	9504-1-0-0	HX4	M22520/5-01	9504-15-1-0	Y877	N/A	4311-0-0-0	P+				
*S410*D	9504-19-0-0	9504-1-0-0	HX4	M22520/5-01	9504-19-1-0	Y524	N/A	4311-0-0-0	P+				
*C4008DS	9504-19-0-0	9504-1-0-0	HX4	9504-19-1-0	Y524	TP-974	N/A	4311-0-0-0	P+				
*S4200D	9509-0-0-0	9509-1-0-0	M310					4311-0-0-0	P+				
*S410*D	9504-0-0-0	9504-1-0-0	HX4	M22520/5-01	9504-2-0-0	Y322	N/A	4311-0-0-0	P+				
*C4101D	9504-14-0-0	9504-1-0-0	HX4	M22520/5-01	9504-14-1-0	Y878	N/A	4311-0-0-0	P+				
*C4102D	9504-13-0-0	9504-1-0-0	HX4	M22520/5-01	9504-13-1-0	Y937	N/A	4311-0-0-0	P+				
*C4103D	9504-15-0-0	9504-1-0-0	HX4	M22520/5-01	9504-15-1-0	Y877	N/A	4311-0-0-0	P+				
*C4104D	9504-15-0-0	9504-1-0-0	HX4	M22520/5-01	9504-15-1-0	Y877	N/A	4311-0-0-0	P+				
FC112M2	9509-3-0-0	9501-0-0-0	A88	M22520/1-01	9502-1-0-0	TH4	M22520/1-03	9099-0-0-0	ITH 1094	M81969/18-01	9081-0-0-0	RTG 2103	M81969/20-01
FC112M2S	9509-3-0-0	9509-4-0-0	GSZ22		9509-5-0-0	TP-1366		9099-0-0-0	ITH 1094	M81969/18-01	9081-0-0-0	RTG 2103	M81969/20-01
FC120M2	9506-0-0-0	9506-1-0-0	A88	M22520/1-01	9502-1-0-0	TH4	M22520/1-03	9099-0-0-0	ITH 1094	M81969/18-01	9081-0-0-0	RTG 2103	M81969/20-01
FCS-26M2	9506-0-0-0	9506-1-0-0	HX3		9506-2-0-0	X530		9099-0-0-0	ITH 1094	M81969/18-01	9081-0-0-0	RTG 2103	M81969/20-01
FS11*H2									ITH 1094	M81969/18-01	9081-0-0-0	RTG 2103	M81969/20-01
FS112M2S									ITH 1094	M81969/18-01	9081-0-0-0	RTG 2103	M81969/20-01
FS120M2									ITH 1094	M81969/18-01	9081-0-0-0	RTG 2103	M81969/20-01
MC11*N									ITH 1094	M81969/18-01	9081-0-0-0	RTG 2103	M81969/20-01
MC11*N-133*									ITH 1094	M81969/18-01	9081-0-0-0	RTG 2103	M81969/20-01
MC112NS	9509-3-0-0	9509-4-0-0	GSZ22		9509-5-0-0	TP-1366		9099-0-0-0	ITH 1094	M81969/18-01	9081-0-0-0	RTG 2103	M81969/20-01
MC120M	9506-0-0-0	9506-1-0-0	A88	M22520/1-01	9502-1-0-0	TH4	M22520/1-03	9099-0-0-0	ITH 1094	M81969/18-01	9081-0-0-0	RTG 2103	M81969/20-01
MCS-26N	9506-0-0-0	9506-1-0-0	HX3		9506-2-0-0	X530		9099-0-0-0	ITH 1094	M81969/18-01	9081-0-0-0	RTG 2103	M81969/20-01
MS11*N									ITH 1094	M81969/18-01	9081-0-0-0	RTG 2103	M81969/20-01
MS12NS									ITH 1094	M81969/18-01	9081-0-0-0	RTG 2103	M81969/20-01
MS120N									ITH 1094	M81969/18-01	9081-0-0-0	RTG 2103	M81969/20-01
FC610M2S	9509-6-0-0	9509-6-1-0	GSZ23		9509-6-2-0	TP-1386		9099-0-0-0	ITH 1094	M81969/18-01	9081-0-0-0	RTG 2103	M81969/20-01
FC612M2		9501-0-0-0	A88	M22520/1-01	9502-19-0-0	TP-1199		9099-3-0-0	TP 1168		2711-0-0-0	P+	
FS610M2S								9099-3-0-0	TP 1168		2711-0-0-0	P+	
FS612M2								9099-3-0-0	TP 1168		2711-0-0-0	P+	
MC610NS	9509-6-0-0	9509-6-1-0	GSZ23		9509-6-2-0	TP-1386		9099-3-0-0	TP 1168		2711-0-0-0	P+	
MC610NS-228.2	9509-6-0-0	9509-6-1-0	GSZ23		9509-6-2-0	TP-1386		9099-3-0-0	TP 1168		2711-0-0-0	P+	
MC612N		9501-0-0-0	A88	M22520/1-01	9502-19-0-0	TP1199		9099-3-0-0	TP 1168		2711-0-0-0	P+	
MC612N-228.2		9501-0-0-0	A88	M22520/1-01	9502-19-0-0	TP1199		9099-3-0-0	TP 1168		2711-0-0-0	P+	
MS610NS								9099-3-0-0	TP 1168		2711-0-0-0	P+	
MS610NS-228.2								9099-3-0-0	TP 1168		2711-0-0-0	P+	
MS612N								9099-3-0-0	TP 1168		2711-0-0-0	P+	
MS612N-228.2								9099-3-0-0	TP 1168		2711-0-0-0	P+	
FC720M2		9507-0-0-0	AFM8	M22520/2-01	9502-22-0-0	K1196		9099-3-0-0	TP 1168		2711-0-0-0	P+	
MC720N3		9507-0-0-0	AFM8	M22520/2-01	9502-27-0-0	K1506		9099-4-0-0	TP1076		9081-2-0-0	RMG2103	
*C4008D	9504-19-0-0	9504-1-0-0	HX4		9504-19-1-0	Y524		N/A			4311-0-0-0	P+	
*C401*D	9509-0-0-0	9509-1-0-0	M310		9509-2-0-0	TP-974		N/A			4311-0-0-0	P+	
*S40**D								N/A			4311-0-0-0	P+	
*S4200D								N/A			4311-0-0-0	P+	
*C410*D	9504-0-0-0	9504-1-0-0	HX4	M22520/5-01	9504-2-0-0	Y322		N/A			4311-0-0-0	P+	
*S410*D	9504-14-0-0	9504-1-0-0	HX4	M22520/5-01	9504-14-1-0	Y878		N/A			4311-0-0-0	P+	
*C4101D	9504-13-0-0	9504-1-0-0	HX4	M22520/5-01	9504-13-1-0	Y937		N/A			4311-0-0-0	P+	
*C4103D	9504-15-0-0	9504-1-0-0	HX4	M22520/5-01	9504-15-1-0	Y877		N/A			4311-0-0-0	P+	
*C4104D	9504-15-0-0	9504-1-0-0	HX4	M22520/5-01	9504-15-1-0	Y877		N/A			4311-0-0-0	P+	

STOOL NOTATION APP



## COMPLIANT PRESS-IN CONNECTOR INSTALLATION TOOLS

USE INDICATED POSITRONIC TOOLS FOR BEST RESULTS

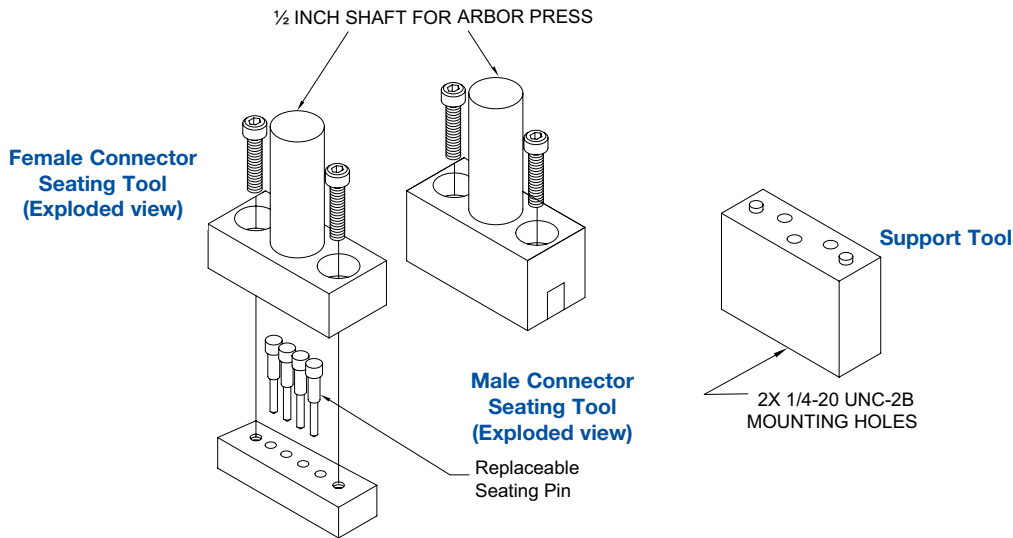

### POSITRONIC RECOMMENDED TOOLS

CONNECTOR VARIANT	CONNECTOR SEATING TOOL WITH ARBOR PRESS SHAFT		CONNECTOR SEATING TOOL WITHOUT ARBOR PRESS SHAFT	
	MALE	FEMALE	MALE	FEMALE
PLA03	9513-1-0-41	9513-13-0-41	9513-1-10-41	9513-13-10-41
PLA04	9513-2-0-41	9513-14-0-41	9513-2-10-41	9513-14-10-41
PLA06	9513-3-0-41	9513-15-0-41	9513-3-10-41	9513-15-10-41
PLA08	9513-4-0-41	9513-16-0-41	9513-4-10-41	9513-16-10-41
PLB06	9513-5-0-41	9513-17-0-41	9513-5-10-41	9513-17-10-41
PLB08	9513-6-0-41	9513-18-0-41	9513-6-10-41	9513-18-10-41
PLB10W2	9513-7-0-41	9513-30-0-41	9513-7-10-41	9513-30-10-41
PLB12	9513-7-0-41	9513-19-0-41	9513-7-10-41	9513-19-10-41
PLB16	9513-8-0-41	9513-20-0-41	9513-8-10-41	9513-20-10-41
PLB20	9513-33-0-41	9513-34-0-41	9513-33-10-41	9513-34-10-41
PLB3W3	9513-6-0-41	9513-18-1-41	9513-6-10-41	9513-18-11-41
PLC09	9513-9-0-41	9513-21-0-41	9513-9-10-41	9513-21-10-41
PLC12	9513-10-0-41	9513-22-0-41	9513-10-10-41	9513-22-10-41
PLC16W4	9513-11-0-41	9513-31-0-41	9513-11-10-41	9513-31-10-41
PLC18	9513-11-0-41	9513-23-0-41	9513-11-10-41	9513-23-10-41
PLC24	9513-12-0-41	9513-24-0-41	9513-12-10-41	9513-24-10-41
PLC30	9513-25-0-41	9513-26-0-41	9513-25-10-41	9513-26-10-41
Arbor press for connector seating tools: 1 ton capacity 4 inch throat				
Replacement pins for connector seating tool	PCS Mixed Density Series Size 20		855-347-18-41	
	PCS Series Size 16		855-347-2-41 (female)	
	PLB3W3 Series Size 12		855-347-11-41 (female)	
	PCS Mixed Density Series Size 8		855-347-19-41	
Support tool for PLB3W3: 9513-401-6-41				

Positronic offers expert assistance in adapting application tooling to your manufacturing environment. Contact our application tooling specialist for assistance.

**SUGGESTED PRINTED BOARD HOLE SIZES FOR COMPLIANT PRESS-IN CONNECTORS**

Traditionally, tin-lead has been a popular plating for printed circuit boards (PCB) holes. However, many PCB hole platings must now be RoHS Compliant. Positronic is pleased to offer **PCB HOLE SIZE FOR RoHS** PCB plating as shown below.

OMEGA & BI-SPRING COMPLIANT PRESS-IN CONTACT HOLE				
BOARD TYPE	CONTACT SIZE / TYPE	RECOMMENDED DRILL HOLE SIZE	RECOMMENDED PLATING	FINISHED HOLE SIZES
TIN-LEAD SOLDER PCB	20 OMEGA	$\frac{\phi 0.0453 \pm 0.0010}{[\phi 1.150 \pm 0.025]}$	0.0006 [15µ] minimum solder over 0.0010 [25µ] min. copper	$\frac{\phi 0.0394 + 0.0035 - 0.0024}{[\phi 1.000 + 0.090 - 0.060]}$
	16 BI-SPRING	$\frac{\phi 0.069 \pm 0.001}{[\phi 1.750 \pm 0.025]}$		$\frac{\phi 0.0630 + 0.0035 - 0.0024}{[\phi 1.600 + 0.090 - 0.060]}$
	12 BI-SPRING	$\frac{\phi 0.102 \pm 0.001}{[\phi 2.59 \pm 0.025]}$		$\frac{\phi 0.096 \pm 0.002}{[\phi 2.44 \pm 0.05]}$
	8 BI-SPRING	$\frac{\phi 0.125 \pm 0.001}{[\phi 3.180 \pm 0.025]}$		$\frac{\phi 0.119 \pm 0.002}{[\phi 3.02 \pm 0.05]}$
RoHS PCB PLATING OPTIONS				
COPPER PCB	20 OMEGA	$\frac{\phi 0.047 \pm 0.001}{[\phi 1.19 \pm 0.025]}$	0.0010 [25µ] min. copper	$\frac{\phi 0.043 \pm 0.002}{[\phi 1.09 \pm 0.05]}$
	16 BI-SPRING	$\frac{\phi 0.069 \pm 0.001}{[\phi 1.750 \pm 0.025]}$		$\frac{\phi 0.0630 + 0.0035 - 0.0024}{[\phi 1.600 + 0.090 - 0.060]}$
	12 BI-SPRING	$\frac{\phi 0.102 \pm 0.001}{[\phi 2.59 \pm 0.025]}$		$\frac{\phi 0.096 \pm 0.002}{[\phi 2.44 \pm 0.05]}$
	8 BI-SPRING	$\frac{\phi 0.125 \pm 0.001}{[\phi 3.180 \pm 0.025]}$		$\frac{\phi 0.119 \pm 0.002}{[\phi 3.02 \pm 0.05]}$
IMMERSION TIN PCB	20 OMEGA	$\frac{\phi 0.047 \pm 0.001}{[\phi 1.19 \pm 0.025]}$	0.000033 ± 0.000006 [0.85 ± 0.15µ] immersion tin over 0.0010 [25µ] min. copper	$\frac{\phi 0.043 \pm 0.002}{[\phi 1.09 \pm 0.05]}$
	16 BI-SPRING	$\frac{\phi 0.069 \pm 0.001}{[\phi 1.750 \pm 0.025]}$		$\frac{\phi 0.0630 + 0.0035 - 0.0024}{[\phi 1.600 + 0.090 - 0.060]}$
	12 BI-SPRING	$\frac{\phi 0.102 \pm 0.001}{[\phi 2.59 \pm 0.025]}$		$\frac{\phi 0.096 \pm 0.002}{[\phi 2.44 \pm 0.05]}$
	8 BI-SPRING	$\frac{\phi 0.125 \pm 0.001}{[\phi 3.180 \pm 0.025]}$		$\frac{\phi 0.119 \pm 0.002}{[\phi 3.02 \pm 0.05]}$
IMMERSION SILVER PCB	20 OMEGA	$\frac{\phi 0.047 \pm 0.001}{[\phi 1.19 \pm 0.025]}$	0.000013 ± 0.000007 [0.34 ± 0.17µ] immersion silver over 0.0010 [25µ] min. copper	$\frac{\phi 0.043 \pm 0.002}{[\phi 1.09 \pm 0.05]}$
	16 BI-SPRING	$\frac{\phi 0.069 \pm 0.001}{[\phi 1.750 \pm 0.025]}$		$\frac{\phi 0.0630 + 0.0035 - 0.0024}{[\phi 1.600 + 0.090 - 0.060]}$
	12 BI-SPRING	$\frac{\phi 0.102 \pm 0.001}{[\phi 2.59 \pm 0.025]}$		$\frac{\phi 0.096 \pm 0.002}{[\phi 2.44 \pm 0.05]}$
	8 BI-SPRING	$\frac{\phi 0.125 \pm 0.001}{[\phi 3.18 \pm 0.025]}$		$\frac{\phi 0.119 \pm 0.002}{[\phi 3.02 \pm 0.05]}$
ELECTROLESS NICKEL / IMMERSION GOLD PCB	20 OMEGA	$\frac{\phi 0.047 \pm 0.001}{[\phi 1.19 \pm 0.025]}$	0.000002 [0.05µ] min. immersion gold over 0.000177 ± 0.000059 [4.5 ± 1.5µ] electroless nickel per IPC-4552 over 0.0010 [25µ] min. copper	$\frac{\phi 0.043 \pm 0.002}{[\phi 1.09 \pm 0.05]}$
	16 BI-SPRING	$\frac{\phi 0.069 \pm 0.001}{[\phi 1.750 \pm 0.025]}$		$\frac{\phi 0.0630 + 0.0035 - 0.0024}{[\phi 1.600 + 0.090 - 0.060]}$
	12 BI-SPRING	$\frac{\phi 0.102 \pm 0.001}{[\phi 2.59 \pm 0.025]}$		$\frac{\phi 0.096 \pm 0.002}{[\phi 2.44 \pm 0.05]}$
	8 BI-SPRING	$\frac{\phi 0.125 \pm 0.001}{[\phi 3.180 \pm 0.025]}$		$\frac{\phi 0.119 \pm 0.002}{[\phi 3.02 \pm 0.05]}$

**“Omega” Termination**  
utilized on signal contacts



**“Bi-Spring” Termination**

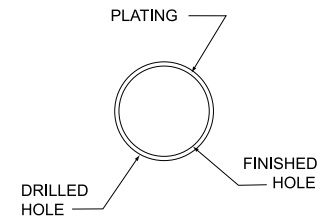

**COMPLIANT PRESS-IN TERMINATION CONTACT HOLE**

**NOTE:** For PCB plating compositions not shown, consult Technical Sales.

**COMPLIANT PRESS-IN USER INFORMATION**

When properly used, Positronic omega and bi-spring compliant press-in terminations provide reliable service even under severe conditions.

**Connectors utilizing this leading technology compliant press-in contact are easy to install:**

1. Inexpensive installation tooling is available from Positronic, to choose the proper installation tool refer to page 56 for part number ordering information.
2. Insert the connector into the P.C. board or backplane and seat connector fully.
3. Secure the connector to the P.C. board or backplane using two self-tapping screws. The screws should be #2 self-tapping screws for plastic.



### RIGHT ANGLE (90°) METAL MOUNTING BRACKETS

CODE B ON STEP 5 OF ORDERING INFORMATION PAGE

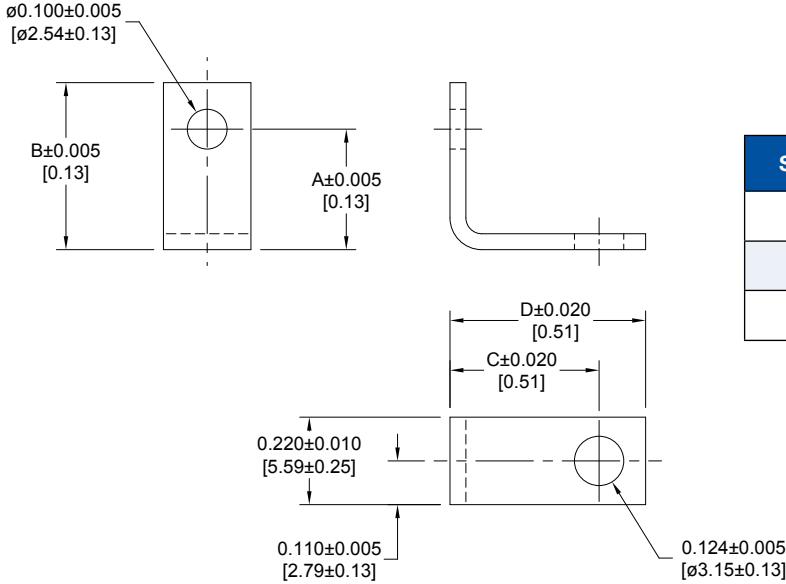

SERIES	A	B	C	D
PLA	0.204 [5.18]	0.321 [8.15]	0.375 [9.53]	0.492 [12.50]
PLB	0.303 [7.70]	0.420 [10.67]	0.375 [9.53]	0.492 [12.50]
PLC	0.401 [10.19]	0.518 [13.16]	0.375 [9.53]	0.492 [12.50]

MATERIAL: Brass, tin plate.

### RIGHT ANGLE (90°) PLASTIC MOUNTING BRACKET WITH CROSS BAR

CODE B3 OR CODE B3N ON STEP 5 OF ORDERING INFORMATION PAGE

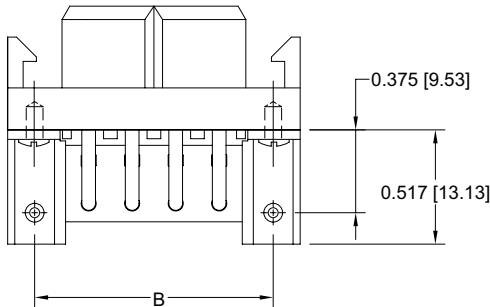

B3 style required  
for right angle (90°)  
press-in connectors

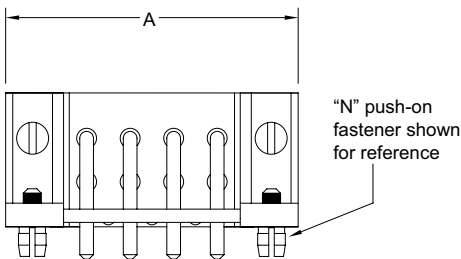

MATERIAL:  
MOUNTING BRACKET/CROSS BAR: Glass filled polyester, UL 94V-0.  
PUSH-ON FASTENERS: Copper alloy, tin plated.

CONNECTOR VARIANT	A	B
PLA03	1.126 [28.60]	0.882 [22.40]
PLA04	1.324 [33.63]	1.080 [27.43]
PLA06	1.718 [43.64]	1.474 [37.44]
PLA08	2.112 [53.64]	1.868 [47.45]
PLB06	1.126 [28.60]	0.882 [22.40]
PLB08	1.324 [33.63]	1.080 [27.43]
PLB12	1.718 [43.64]	1.474 [37.44]
PLB16	2.112 [53.64]	1.868 [47.45]
PLC09	1.126 [28.60]	0.882 [22.40]
PLC12	1.324 [33.63]	1.080 [27.43]
PLC18	1.718 [43.64]	1.474 [37.44]
PLC24	2.112 [53.64]	1.868 [47.45]
PLC30	2.506 [63.65]	2.262 [57.45]



**PUSH-ON FASTENERS**

CODE BN OR CODE N ON STEP 5 OF ORDERING INFORMATION PAGE

**CODE BN**

FOR USE WITH RIGHT ANGLE (90°) CONNECTOR

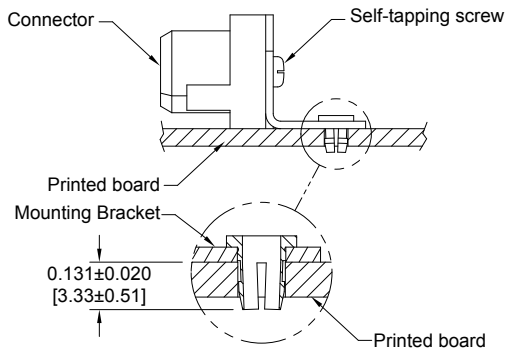

**CODE N**

FOR USE WITH STRAIGHT SOLDER CONNECTOR

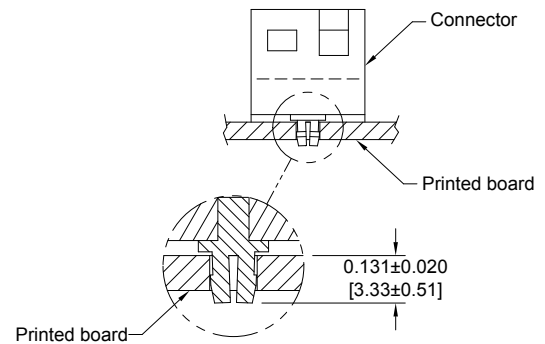

**MATERIAL:** Spring tempered copper alloy, tin plated.

**SUGGESTED PRINTED BOARD HOLE SIZES:**

Suggest 0.123 ±0.002 [3.12] Ø hole in printed board for mounting connector with push-on fasteners.

**MOUNTING SCREWS**

CODE ST2, ST3, ST4, SS2, SS3, OR SS4 ON STEP 5 OF ORDERING INFORMATION PAGE

**NOTE: MOUNTING SCREWS FOR RIGHT ANGLE CONNECTORS ARE ORDERED SEPARATELY  
USING PART NUMBERS SHOWN IN CHART BELOW.**

Stresses that occur during coupling and uncoupling of connectors or through shock and vibration of systems can be transferred to backplanes or P.C. boards through press-in connector terminations. Avoid concern over electrical integrity of the connector to board interface by using mounting screws. Bellcore GR1217 details a preference for the use of mounting hardware and we recommend this practice.

SCREWS ARE #2 SELF-TAPPING FOR PLASTIC.

MOUNTING STYLE OPTION	MATERIAL OPTIONS	PART NUMBER	THREAD LENGTH	P.C. BOARED THICKNESS
ST2	STEEL	A4546-7-1-97	0.250±0.030 [6.35±0.76]	0.093 [2.36]
ST3	STEEL	A4546-7-2-97	0.312±0.030 [7.93±0.76]	0.125 [3.18]
ST4	STEEL	A4546-7-3-97	0.375±0.030 [9.53±0.76]	0.175 [4.45]
SS2	STAINLESS STEEL	A4546-7-6-4	0.250±0.030 [6.35±0.76]	0.093 [2.36]
SS3	STAINLESS STEEL	A4546-7-7-4	0.312±0.030 [7.93±0.76]	0.125 [3.18]
SS4	STAINLESS STEEL	A4546-7-8-4	0.375±0.030 [9.53±0.76]	0.175 [4.45]

CONSULT TECHNICAL SALES IF AN ALTERNATE SCREW IS REQUIRED.

DIMENSIONS ARE IN INCHES [MILLIMETERS].  
ALL DIMENSIONS ARE SUBJECT TO CHANGE.



### POWER CONNECTION SYSTEMS HOOD

CODE 5 ON STEP 6 OF ORDERING INFORMATION PAGE

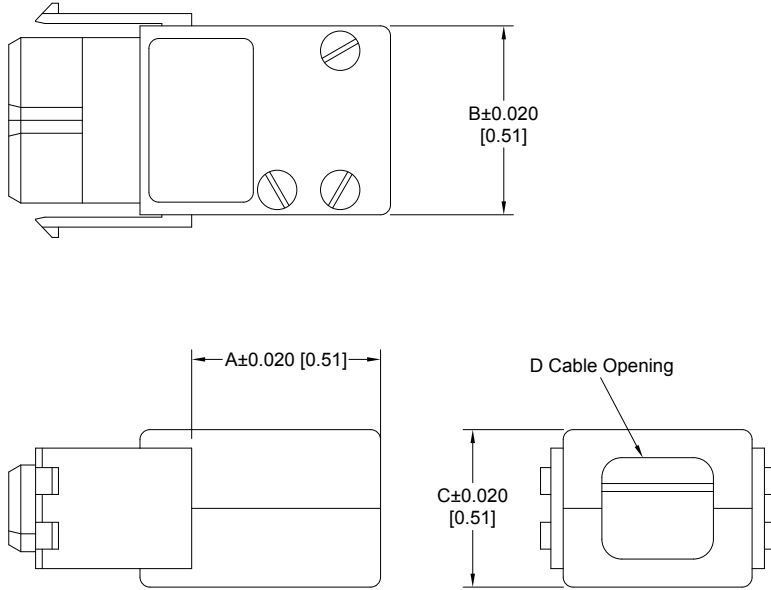

Features internal cable clamp.

CONNECTOR VARIANT	A	B	C	D
PLA03	1.000 [25.40]	0.752 [19.10]	0.594 [15.09]	0.312 [7.92] x 0.363 [9.22]
PLA04	1.000 [25.40]	0.950 [24.13]	0.594 [15.09]	0.312 [7.92] x 0.561 [14.25]
PLA06	1.000 [25.40]	1.344 [34.14]	0.594 [15.09]	0.312 [7.92] x 0.955 [24.26]
PLA08	1.000 [25.40]	1.738 [44.15]	0.594 [15.09]	0.312 [7.92] x 1.349 [34.26]
PLB06	1.000 [25.40]	0.752 [19.10]	0.792 [20.12]	0.510 [12.95] x 0.363 [9.22]
PLB08	1.000 [25.40]	0.950 [24.13]	0.792 [20.12]	0.510 [12.95] x 0.561 [14.25]
PLB12	1.000 [25.40]	1.344 [34.14]	0.792 [20.12]	0.510 [12.95] x 0.955 [24.26]
PLB16	1.000 [25.40]	1.738 [44.15]	0.792 [20.12]	0.510 [12.95] x 1.349 [34.26]
PLB3W3	1.000 [25.40]	0.950 [24.13]	0.792 [20.12]	0.510 [12.95] x 0.561 [14.25]
PLC09	1.000 [25.40]	0.752 [19.10]	0.990 [25.15]	0.708 [17.98] x 0.363 [9.22]
PLC12	1.000 [25.40]	0.950 [24.13]	0.990 [25.15]	0.708 [17.98] x 0.561 [14.25]
PLC18	1.000 [25.40]	1.344 [34.14]	0.990 [25.15]	0.708 [17.98] x 0.955 [24.26]
PLC24	1.000 [25.40]	1.738 [44.15]	0.990 [25.15]	0.708 [17.98] x 1.349 [34.26]
PLC30	1.000 [25.40]	2.132 [54.15]	0.990 [25.15]	0.708 [17.98] x 1.743 [44.27]

### HOOD FOR USE WITH PLS5W5 CONNECTOR

CODE 5 ON STEP 6 OF ORDERING INFORMATION PAGE

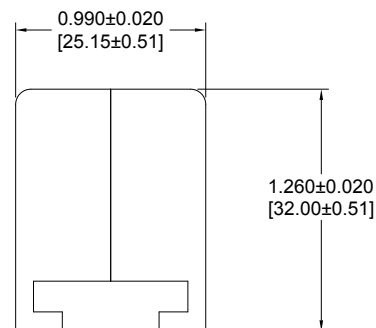
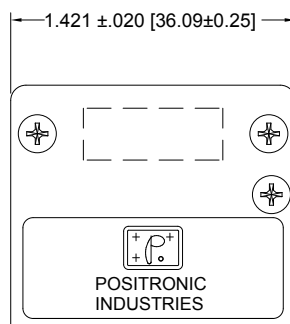

For PLS5W5  
Connector Only

Features internal cable clamp.



CONTACT TECHNICAL SALES  
FOR AVAILABILITY OF 7W7 VARIANT.

## PANEL MOUNT CONNECTORS WITH QUICK RELEASE MOUNTING CLIP

CODE 6 IN STEP 6 OF  
ORDERING INFORMATION PAGE

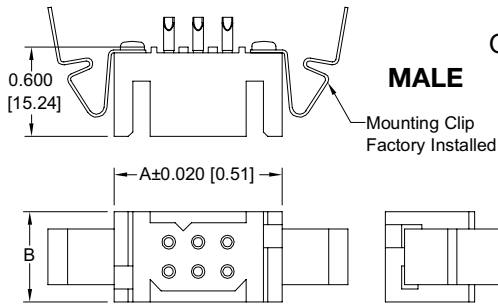

**MALE**

Mounting Clip  
Factory Installed

For connection system 8

Typical part number: PLB06M206C1

CONNECTOR VARIANTS	A	B
PLA03	1.126 [28.60]	0.408 [10.36]
PLA04	1.324 [33.63]	0.408 [10.36]
PLA06	1.718 [43.64]	0.408 [10.36]
PLA08	2.112 [53.64]	0.408 [10.36]
PLB06	1.126 [28.60]	0.606 [15.39]
PLB08	1.324 [33.63]	0.606 [15.39]
PLB12	1.718 [43.64]	0.606 [15.39]

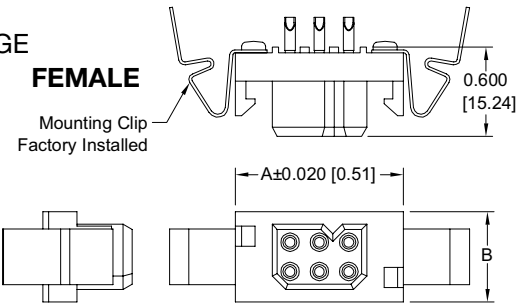

**FEMALE**

Mounting Clip  
Factory Installed

Typical part number: PLB06F206C1

CONNECTOR VARIANTS	A	B
PLB16	2.112 [53.64]	0.606 [15.39]
PLB20	2.506 [63.65]	0.606 [15.39]
PLC09	1.126 [28.60]	0.802 [30.37]
PLC12	1.324 [33.63]	0.802 [30.37]
PLC18	1.718 [43.64]	0.802 [30.37]
PLC24	2.112 [53.64]	0.802 [30.37]
PLC30	2.506 [63.65]	0.802 [30.37]

## PANEL MOUNT CONNECTORS WITH QUICK RELEASE MOUNTING CLIP FOR REMOVABLE CONTACTS

CODE 6 IN STEP 6 OF  
ORDERING INFORMATION PAGE

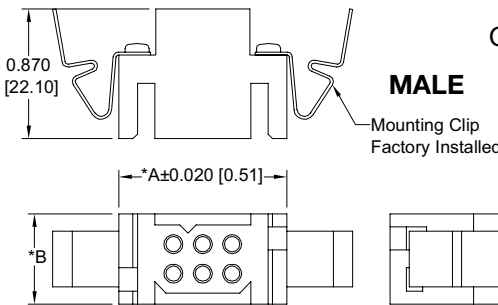

**MALE**

Mounting Clip  
Factory Installed

For connection system 8

Typical part number: PLB06M1060

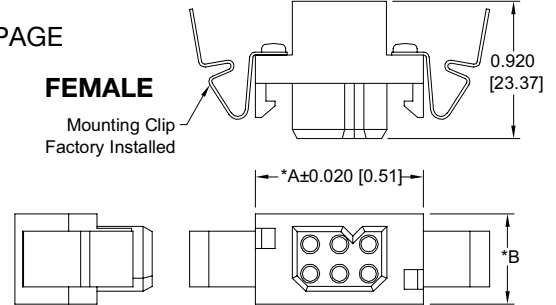

**FEMALE**

Mounting Clip  
Factory Installed

Typical part number: PLB06F1060

\*Note: See chart  
above for connector  
dimensions.

CONNECTOR VARIANTS	A	B	C
PLA03	1.600 [40.64]	1.168 [29.67]	0.445 [11.30]
PLA04	1.798 [45.67]	1.366 [34.70]	0.445 [11.30]
PLA06	2.192 [55.68]	1.760 [44.70]	0.445 [11.30]
PLA08	2.586 [65.68]	2.154 [54.71]	0.445 [11.30]
PLB06	1.600 [40.64]	1.168 [29.67]	0.643 [16.33]
PLB08	1.798 [45.67]	1.366 [34.70]	0.643 [16.33]
PLB12	2.192 [55.68]	1.760 [44.70]	0.643 [16.33]
PLB16	2.586 [65.68]	2.154 [54.71]	0.643 [16.33]
PLB20	2.980 [75.69]	2.548 [64.72]	0.643 [16.33]
PLC09	1.600 [40.64]	1.168 [29.67]	0.839 [21.31]
PLC12	1.798 [45.67]	1.366 [34.70]	0.839 [21.31]
PLC18	2.192 [55.68]	1.760 [44.70]	0.839 [21.31]
PLC24	2.586 [65.68]	2.154 [54.71]	0.839 [21.31]
PLC30	2.980 [75.69]	2.548 [64.72]	0.839 [21.31]

## PANEL CUTOUT FOR USE WITH QUICK RELEASE MOUNTING CLIPS

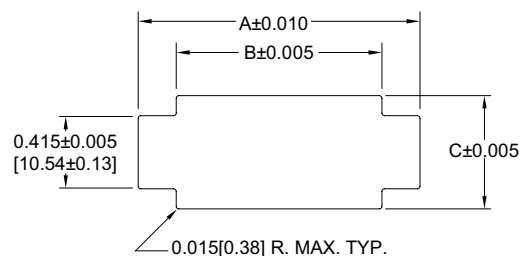

Maximum panel thickness: 0.063 [1.60] nominal.

DIMENSIONS ARE IN INCHES [MILLIMETERS].  
ALL DIMENSIONS ARE SUBJECT TO CHANGE.



## PANEL MOUNT CONNECTORS WITH \*FIXED STYLE MOUNTING CLIP

CODE 81, 82 AND 83 IN STEP 6 OF ORDERING INFORMATION PAGE

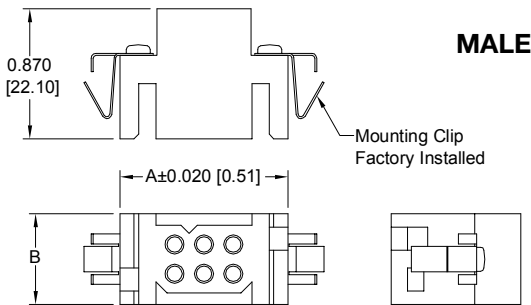

Typical part number:  
**PLB06M10810**

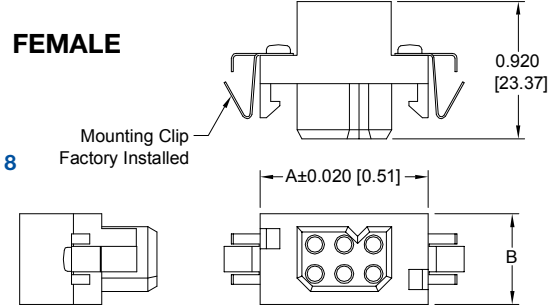

Typical part number:  
**PLB06F10810**

For connection system 8

CLIP MATERIAL: Beryllium copper, nickel plated

PART NUMBER	PANEL THICKNESS
PL*****81*	0.040 [1.02]
PL*****82*	0.060 [1.52]
PL*****83*	0.090 [2.29]

\* May be used with either fixed solder or removable contact connector insulators.

CONNECTOR VARIANTS	A	B
PLA03	1.126 [28.60]	0.408 [10.36]
PLA04	1.324 [33.63]	0.408 [10.36]
PLA06	1.718 [43.64]	0.408 [10.36]
PLA08	2.112 [53.64]	0.408 [10.36]
PLB06	1.126 [28.60]	0.606 [15.39]
PLB08	1.324 [33.63]	0.606 [15.39]
PLB12	1.718 [43.64]	0.606 [15.39]
PLB16	2.112 [53.64]	0.606 [15.39]
PLB20	2.506 [63.65]	0.606 [15.39]
PLC09	1.126 [28.60]	0.802 [30.37]
PLC12	1.324 [33.63]	0.802 [30.37]
PLC18	1.718 [43.64]	0.802 [30.37]
PLC24	2.112 [53.64]	0.802 [30.37]
PLC30	2.506 [63.65]	0.802 [30.37]

## PANEL CUTOUT FOR USE WITH FIXED STYLE MOUNTING CLIPS

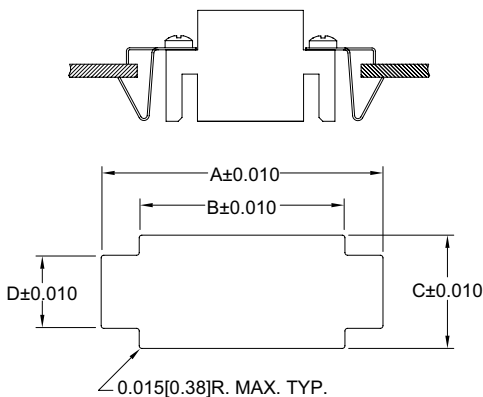

CONNECTOR VARIANTS	A	B	C	D
PLA03	1.380 [35.05]	1.150 [29.21]	0.445 [11.30]	0.193 [4.90]
PLA04	1.578 [40.08]	1.348 [34.24]	0.445 [11.30]	0.193 [4.90]
PLA06	1.972 [50.09]	1.742 [44.25]	0.445 [11.30]	0.193 [4.90]
PLA08	2.366 [60.10]	2.136 [54.25]	0.445 [11.30]	0.193 [4.90]
PLB06	1.380 [35.05]	1.150 [29.21]	0.643 [16.33]	0.300 [7.62]
PLB08	1.578 [40.08]	1.348 [34.24]	0.643 [16.33]	0.300 [7.62]
PLB12	1.972 [50.09]	1.742 [44.25]	0.643 [16.33]	0.300 [7.62]
PLB16	2.366 [60.10]	2.136 [54.25]	0.643 [16.33]	0.300 [7.62]
PLB20	2.760 [70.10]	2.530 [64.26]	0.643 [16.33]	0.300 [7.62]
PLC09	1.380 [35.05]	1.150 [29.21]	0.839 [21.31]	0.300 [7.62]
PLC12	1.578 [40.08]	1.348 [34.24]	0.839 [21.31]	0.300 [7.62]
PLC18	1.972 [50.09]	1.742 [44.25]	0.839 [21.31]	0.300 [7.62]
PLC24	2.366 [60.10]	2.136 [54.25]	0.839 [21.31]	0.300 [7.62]
PLC30	2.760 [70.10]	2.530 [64.26]	0.839 [21.31]	0.300 [7.62]

PANEL MOUNT CUTOUT

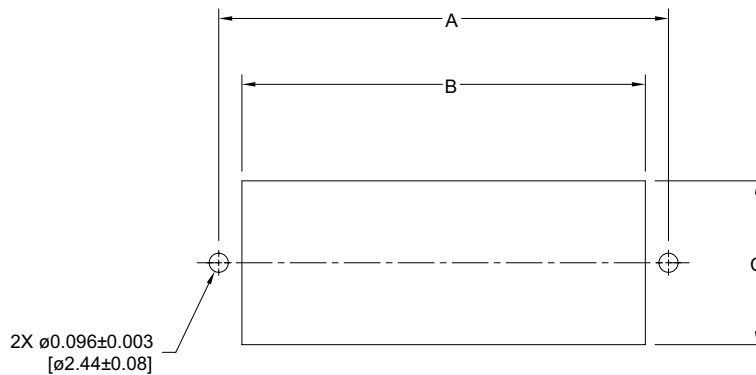

CONNECTOR VARIANTS	A $\pm 0.005$	B $\pm 0.005$	C $\pm 0.005$
PLA03	0.882 [22.40]	0.650 [16.51]	0.430 [10.92]
PLA04	1.079 [27.41]	0.847 [21.51]	0.430 [10.92]
PLA06	1.473 [37.41]	1.241 [31.52]	0.430 [10.92]
PLA08	1.867 [47.42]	1.635 [41.53]	0.430 [10.92]
PLB06	0.882 [22.40]	0.650 [16.51]	0.627 [15.93]
PLB08	1.079 [27.41]	0.847 [21.51]	0.627 [15.93]
PLB12	1.473 [37.41]	1.241 [31.52]	0.627 [15.93]
PLB16	1.867 [47.42]	1.635 [41.53]	0.627 [15.93]
PLB20	2.262 [57.45]	2.029 [51.54]	0.627 [15.93]
PLB3W3	1.079 [27.41]	0.847 [21.51]	0.627 [15.93]
PLB10W2	1.473 [37.41]	1.241 [31.52]	0.627 [15.93]
PLC09	0.882 [22.40]	0.650 [16.51]	0.824 [20.93]
PLC12	1.079 [27.41]	0.847 [21.51]	0.824 [20.93]
PLC18	1.473 [37.41]	1.241 [31.52]	0.824 [20.93]
PLC24	1.867 [47.42]	1.635 [41.53]	0.824 [20.93]
PLC30	2.262 [57.45]	2.029 [51.54]	0.824 [20.93]
PLC16W4	1.473 [37.41]	1.241 [31.52]	0.824 [20.93]



Positronic  
connectpositronic.com

# BLIND MATING SYSTEM AND PANEL CUTOUT

Power  
Connection  
Systems

## BLIND MATING SYSTEM CODE 11, 12, 13 AND 14 IN STEP 6 OF ORDERING INFORMATION PAGE

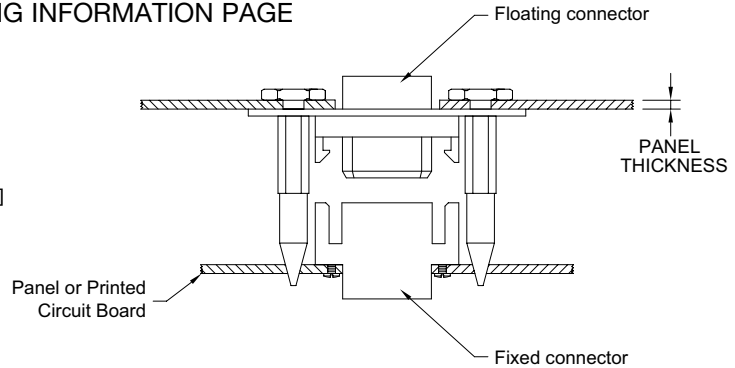
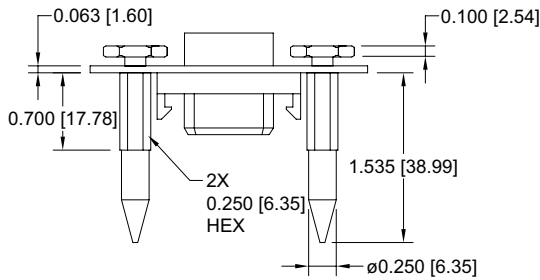
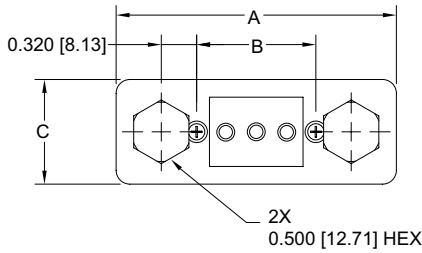

Typical Part Number: **PLB08F10120**

## PANEL CUTOUT FOR USE WITH FLOATING AND FIXED CONNECTOR BLIND MATING SYSTEMS

### FLOATING CONNECTOR

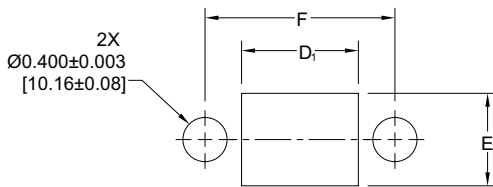

### FIXED CONNECTOR

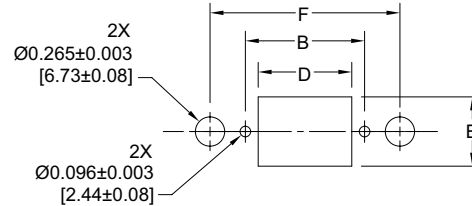

**NOTE:** Panel thickness may impact the orientation of mating end of blind mate pin. Shimming between the panel and the head of the blind mate pin may be necessary to minimize tilt of the blind mate system. Contact technical sales for additional technical information.

#### MATERIALS AND FINISHES:

- BLIND MATING PLATE:** Stainless steel.
- BLIND MATING GUIDE:** Stainless steel, passivated.
- FLOAT SCREW:** Steel, zinc plate with chromate seal.

Blind mating system provides lead in for 0.100 [2.54] axial misalignment.

Blind mating system sold in a kit containing a connector - plate assembly, Blind mating guides, and float screws.

CONNECTOR VARIANTS	A	B ±0.005	C	D ±0.005	D1 ±0.005	E ±0.005	E1 ±0.005	F ±0.005
PLA03	2.340 [59.44]	0.882 [22.40]	0.750 [19.05]	0.650 [16.51]	0.860 [21.84]	0.430 [10.92]	0.640 [16.26]	1.522 [38.66]
PLA04	2.537 [64.44]	1.079 [27.41]	0.750 [19.05]	0.847 [21.51]	1.057 [26.85]	0.430 [10.92]	0.640 [16.26]	1.719 [43.66]
PLA06	2.931 [74.45]	1.473 [37.41]	0.750 [19.05]	1.241 [31.52]	1.451 [36.86]	0.430 [10.92]	0.640 [16.26]	2.113 [53.67]
PLA08	3.325 [84.46]	1.867 [47.42]	0.750 [19.05]	1.635 [41.53]	1.845 [46.86]	0.430 [10.92]	0.640 [16.26]	2.507 [63.68]
PLB06	2.340 [59.44]	0.882 [22.40]	0.947 [24.05]	0.650 [16.51]	0.860 [21.84]	0.627 [15.93]	0.837 [21.26]	1.522 [38.66]
PLB08	2.537 [64.44]	1.079 [27.41]	0.947 [24.05]	0.847 [21.51]	1.057 [26.85]	0.627 [15.93]	0.837 [21.26]	1.719 [43.66]
PLB12	2.931 [74.45]	1.473 [37.41]	0.947 [24.05]	1.241 [31.52]	1.451 [36.86]	0.627 [15.93]	0.837 [21.26]	2.113 [53.67]
PLB16	3.325 [84.46]	1.867 [47.42]	0.947 [24.05]	1.635 [41.53]	1.845 [46.86]	0.627 [15.93]	0.837 [21.26]	2.507 [63.68]
PLB3W3	2.537 [64.44]	1.079 [27.41]	0.947 [24.05]	0.847 [21.51]	1.057 [26.85]	0.627 [15.93]	0.837 [21.26]	1.719 [43.66]
PLC09	2.340 [59.44]	0.882 [22.40]	1.144 [29.06]	0.650 [16.51]	0.860 [21.84]	0.824 [20.93]	1.034 [26.26]	1.522 [38.66]
PLC12	2.537 [64.44]	1.079 [27.41]	1.144 [29.06]	0.847 [21.51]	1.057 [26.85]	0.824 [20.93]	1.034 [26.26]	1.719 [43.66]
PLC18	2.931 [74.45]	1.473 [37.41]	1.144 [29.06]	1.241 [31.52]	1.451 [36.86]	0.824 [20.93]	1.034 [26.26]	2.113 [53.67]
PLC24	3.325 [84.46]	1.867 [47.42]	1.144 [29.06]	1.635 [41.53]	1.845 [46.86]	0.824 [20.93]	1.034 [26.26]	2.507 [63.68]
PLC30	3.720 [94.49]	2.262 [57.45]	1.144 [29.06]	2.029 [51.54]	2.239 [56.87]	0.824 [20.93]	1.034 [26.26]	2.902 [73.71]

PART NUMBER	PANEL THICKNESS
PL****11* PLB3W3*10110	0.040 [1.02]
PL****12* PLB3W3*10120	0.060 [1.52]
PL****13* PLB3W3*10130	0.090 [2.28]
PL****14* PLB3W3*10140	0.120 [3.05]

# Connector Excellence<sup>®</sup>

## Positronic HIGH RELIABILITY Products

### POWER



#### FEATURES:

- High current density
- Energy saving - low contact resistance
- AC/DC operation in a single connector
- Signal contacts for hardware management
- Blind mating
- Sequential mating
- Large surface area contact mating system
- Wide variety of accessories
- Customer-specified contact arrangements
- Modular tooling which produces a single piece connector insert

**Contact Sizes:** 0, 8, 12, 16, 20, 22 and 24  
**Current Ratings:** To 200 amperes per contact  
**Terminations:** Crimp and fixed cable connector, straight solder, right angle (90°) solder, straight compliant press-in and right angle (90°) compliant press-in

**Configurations:** Multiple variants in a variety of package sizes  
**Compliance:** PICMG 2.11, PICMG 3.0, VITA 41, DSCC, GSFC S-311-P-4, GSFC S-311-P-10

### D-SUBMINIATURE



#### FEATURES:

- Four performance levels available for best cost/performance ratio: professional, industrial, military and space-flight quality
- Options include high voltage, coax, thermocouple and air coupling contacts; environmentally sealed and dual port connector packages including mixed density
- Broad selection of accessories
- Size 20 and 22 contacts suitable for use in carrying power
- IP65, IP67

**Contact Sizes:** 8, 16, 20 and 22  
**Current Ratings:** To 100 amperes  
**Terminations:** Crimp, wire solder, straight solder, right angle (90°) compliant press-in and right angle (90°) compliant press-in

**Configurations:** Multiple variants in both standard and high densities, seven connector housing sizes  
**Qualifications:** MIL-DTL-24308, GSFC S-311-P-4, GSFC S-311-P-10, SAE AS39029, DSCC

### RECTANGULAR



#### FEATURES:

- Two performance levels available: industrial quality and military quality
- A wide variety of accessories
- Broad selection of contact arrangement and package sizes
- Connector coding device (keying) options

**Contact Sizes:** 16, 20 and 22  
**Current Ratings:** To 13 amperes nominal  
**Terminations:** Crimp, wire solder, straight solder, right angle (90°) solder, and straight compliant press-in

**Configurations:** Multiple variants in both standard and high densities, thirty package sizes  
**Qualifications:** MIL-DTL-28748, SAE AS39029, CCITT V,35

### CIRCULAR



#### FEATURES:

- Non-corrodible / lightweight composite construction
- EMI/RFI shielded versions
- Thermocouple contacts
- Environmentally sealed versions
- Rear insertion/ front release of removable contacts
- Two level sequential mating
- Overmolding available on full assemblies

**Contact Sizes:** 12, 16, 20 and 22  
**Current Ratings:** To 25 amperes nominal  
**Terminations:** Crimp, wire solder, straight solder, and right angle (90°) solder  
**Configurations:** Multiple variants in four package sizes  
**Qualifications:** Environmental protection to IP67

### CABLE



#### FEATURES:

- Shorten the supply chain and reduce additional costs and delays by "cabling" your Positronic connector selection
- Overmolding available
- Shielded and environmentally sealed versions available
- Power cables and access boxes which meet the SAE J2496 specification

- ✓ Design assemblies in accordance with customer specifications.
- ✓ Prepare wire harness connector configuration and performance specifications.
- ✓ Design each system in accordance with applicable customer, domestic, and international standards.
- ✓ Define and conduct performance and verification testing.

### HERMETIC



#### FEATURES:

- Intended for use as an electrical feedthrough in high vacuum applications
- Helium leakage rate at ambient temperature:  $< 5 \times 10^{-9}$  mbar.l/s under a vacuum  $1.5 \times 10^{-2}$  mbar
- Signal, power, coax and high voltage versions available
- Connectors can be mounted on flange assembly per customer specification

**Contact Sizes:** 8, 12, 16, 20 and 22  
**Current Ratings:** To 40 amperes nominal  
**Terminations:** Feedthrough is standard; flying leads and board mount available upon request  
**Configurations:** See D-subminiature and circular configurations above  
**Compliance:** Space-D32

For more information, visit [www.connectpositronic.com](http://www.connectpositronic.com) or call your nearest Positronic sales office listed on the back of this catalog.



**Positronic**<sup>®</sup>

an **Amphenol** company

### Divisional Headquarters

#### Positronic | Americas

1325 N Eldon Ave  
Springfield MO 65803 USA

+1 800 641 4054  
info@connectpositronic.com

#### Positronic | Europe

Z.I. d'Engachies  
46, route d'Engachies  
F-32020 Auch Cedex 9 France

+33 5 6263 4491  
contact@connectpositronic.com

#### Positronic | Asia

3014A Ubi Rd 1 #07-01  
Singapore 408703

+65 6842 1419  
singapore@connectpositronic.com

### Sales Offices

Positronic has local sales representation all over the world. To find the nearest sales office, please visit [www.connectpositronic.com/sales](http://www.connectpositronic.com/sales)

LOCAL REPRESENTATIONS