

COMPACT POWER CONNECTORS

Power Connectors



Positronic[®]
an Amphenol company



LOOK FOR OUR
NEW PRODUCTS!



Panel Mount

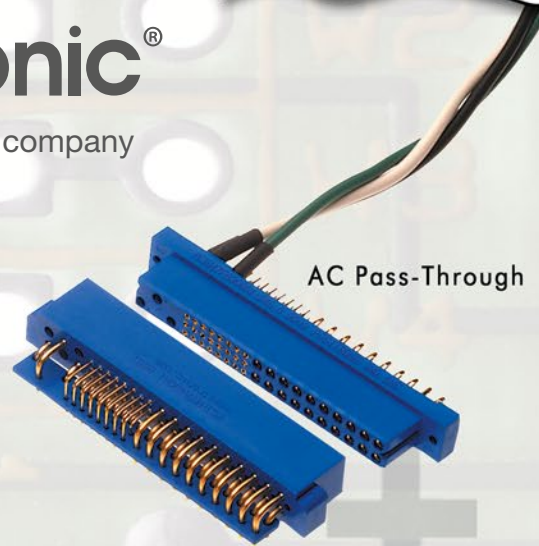

AC Pass-Through

The power interface for plug-in power supplies or other chassis mount applications

Right Angle (90°)
PCB Mount

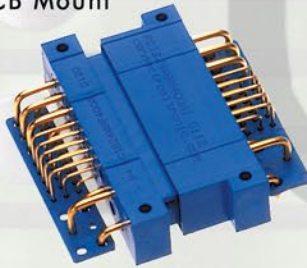

Five Package Sizes

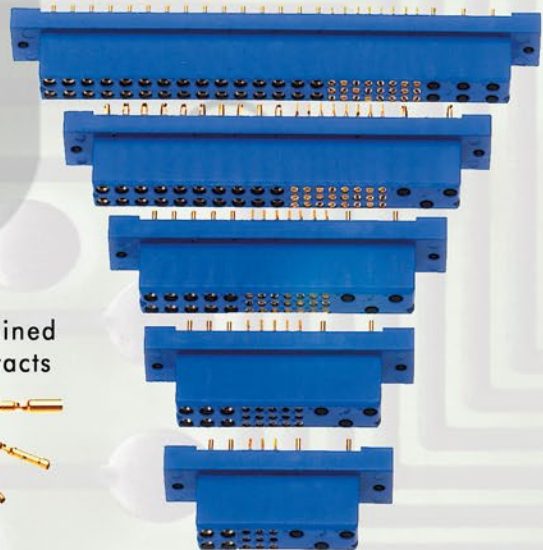

Solid, Machined
Power Contacts



Connector Excellence[®]

Positronic Provides Complete Capability

Mission Statement

"To utilize product flexibility and application assistance to present interconnect solutions which represent value to customers worldwide."

Experience

- Founded in **1966**
- **Involvement** in the development of international connector specifications through EIA[®], IEC and ISO as well as PICMG[®] and VITA.
- Introduction of new and **unique connector products** to the electronics industry.
- Patent holder for many **unique connector features and manufacturing techniques**.
- **Vertically integrated** manufacturing – raw materials to finished connectors.



Technology

- **Expertise** with solid machined contacts provides a variety of high reliability connectors including high current density power connectors.
- Quality Assurance lab is **capable of testing** to IEC, EIA, UL, C.UL, military and customer-specified requirements.
- **In-house design and development** of connectors based on market need or individual customer requirements.
- **Internal manufacturing capabilities** include automatic precision contact machining, injection molding, stamping, plating operations and connector assembly.
- **Manufacturing locations** in southwest Missouri, U.S.A. (headquarters); Puerto Rico, France, China, Singapore, and India. Total square footage: 369,000.



Support

- **Quality Systems:** Select locations qualified to ISO9001:2000, ISO14001, AS9100, MIL-STD-790 and customer "dock to stock" programs. Applicable products qualified to MIL-DTL-24308, SAE AS39029, DSCC 85039, MIL-DTL-28748, Space D32, GSFC S-311-P-4 and GSFC S-311-P-10.
- Compliance to a variety of international and customer specific **environmental requirements**.
- Large **in-house inventory** of finished connectors. Customer specific **stocking programs**.
- Factory direct **technical sales support** in major cities worldwide.
- **One-on-one customer support** from worldwide factory locations.
- World class **web site**.
- **Value-added solutions** and willingness to **develop custom products** with reasonable price and delivery.



Regional Headquarters

Springfield, MO



Auch, France



Singapore



Products described within this catalog may be protected by one or more of the following US patents:

#4,900,261 #5,255,580 #5,329,697
#6,260,268 #6,835,079 #7,115,002

Patented in Canada, 1992 Other Patents Pending

Positronic Industries' **FEDERAL SUPPLY CODE** (Cage Code)
FOR MANUFACTURERS is **28198**

Unless otherwise specified, **dimensional tolerances** are:

- 1) ± 0.001 inches [0.03 mm] for male contact mating diameters.
- 2) ± 0.003 inches [0.08 mm] for contact termination diameters.
- 3) ± 0.005 inches [0.13 mm] for all other diameters.
- 4) ± 0.015 inches [0.38 mm] for all other dimensions.

POSITRONIC[®] IS AN ITAR REGISTERED COMPANY

Information in this catalog is proprietary to Positronic and its subsidiaries. Positronic believes the data contained herein to be reliable. Since the technical information is given free of charge, the user employs such information at his own discretion and risk. Positronic Industries assumes no responsibility for results obtained or damages incurred from use of such information in whole or in part.

Positronic[®], Positronic Industries, Inc.[®], P+ logo, Positronic Global Connector Solutions[®], Connector Excellence[®] and their logo designs are registered trademarks of Positronic Industries, Inc.

COMPACT POWER CONNECTORS

THE POWER INTERFACE FOR PLUG-IN POWER SUPPLIES OR OTHER CHASSIS MOUNT APPLICATIONS

- High current through a small package
- Three level sequential mating
- A.C. or D.C. input, output and power management in a simple package
- Multiple power contacts provide efficient current distribution of multi-voltage outputs
- Multiple output contacts can be paralleled for the increased current requirements of distributed power applications
- Superior blind mating

Connectors Designed To Customer Specifications

Positronic connectors can be modified to customers specifications.

Examples: select loading of contacts for cost savings or to gain creepage and clearance distances; longer PCB terminations; customer specified hardware.

Positronic can develop and tool new connector designs with reasonable price and delivery.

Contact Technical Sales with your particular requirements.



Compact Power Connector Applications

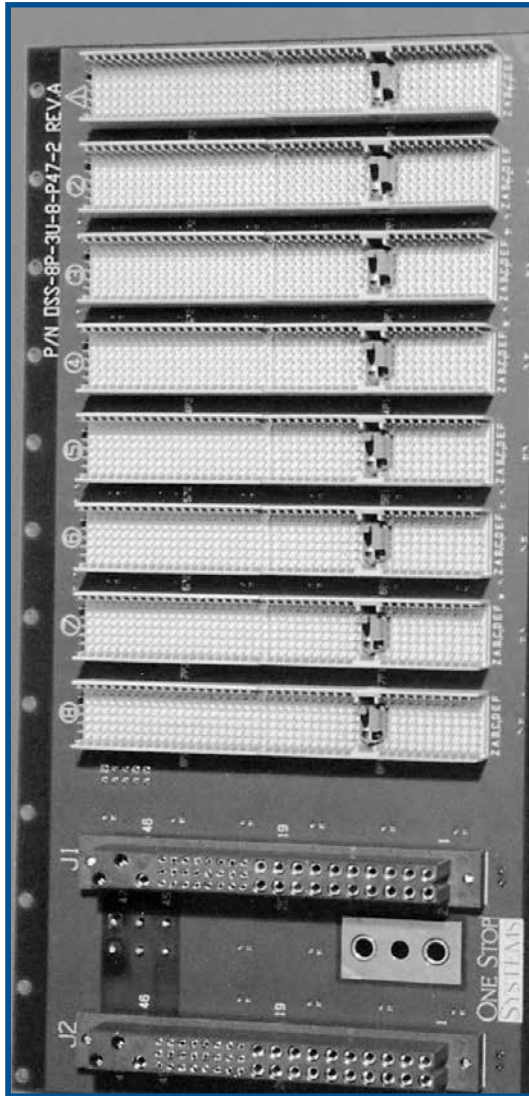

Courtesy of
One Stop Systems
www.onestopsystems.com

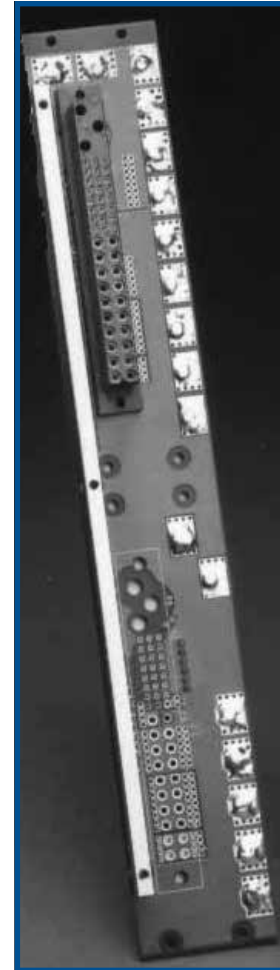

Courtesy of
Hybricon Corporation
www.hybricon.com

Courtesy of
Kaparel Corporation
www.kaparel.com

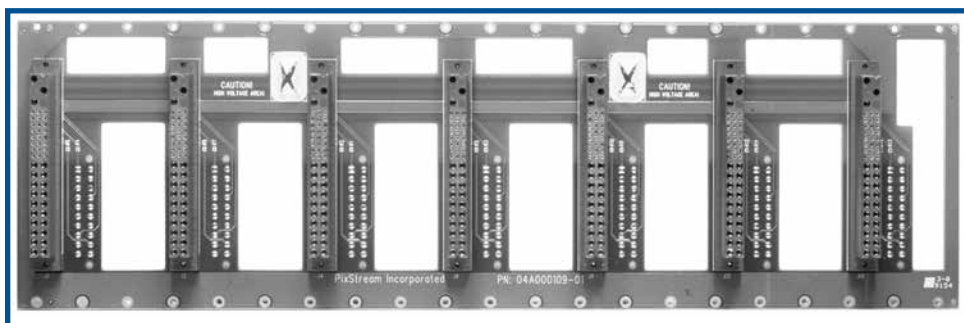

Please visit the website of the companies listed to view a wide variety of product offerings.

Courtesy of Deltron Inc.
www.deltroninc.com



1U Deltron power supply with Positronic interface



Courtesy of
Tracewell Power, Inc.
www.tracewell.com

Positronic Industries is proud to participate in the important work of the following organizations....



PICMG® and PICMG® logo are registered trademarks of the PCI Industrial Computers Manufacturers Group.

www.picmg.com



www.pdma.com

This page intentionally left blank



GENERAL INFORMATION

PCI Connection Systems	1-2
Current Rating Information	3
Temperature Rise Curves	4-6
AC/DC Input Keying	6-7
Large Surface Area Contact Mating System	8
Compliant Terminations	9
Application Specific Arrangements	10
Special Options	11

PCIH SERIES

General Product Information	12
Technical Characteristics	13-14
Connector Outline and Mating Dimensions	15
Code 3 Female - Straight Solder Connector, Straight Solder Connector with A.C. Pass-Through and Other Special Options	16-19
Code 3 Male - Straight Solder Connector and Other Special Options	20-21
Code 4 Female - Right Angle (90°) Board Mount Connector, Right Angle (90°) Board Mount Connector with A.C. Pass-Through and Other Special Options	22-25
Code 4 Male - Right Angle (90°) Board Mount Connector and Other Special Options	26-28
Code 8 Female - Panel Mount Connector	29
Code 93 or 94 Female - Compliant Press-Fit Board Mount Connector, Compliant Press-Fit Board Mount Connector with A.C. Pass-Through and Other Special Options	30-33
Code 93 or 94 Male - Compliant Press-Fit Board Mount Connector and Other Special Options	34-35
Ordering Information	36

PCIA SERIES

General Product Information	37
Technical Characteristics	38
Connector Outline and Mating Dimensions	39
Code 3 Female and Male - Straight Solder Connector	40
Code 4 Female - Right Angle (90°) Board Mount Connector	41
Code 4 Male - Right Angle (90°) Board Mount Connector	42
Code 8 Female - Panel Mount Connector	43
Code 93 or 94 Female and Male - Compliant Press-Fit Board Mount Connector	44
Ordering Information	45

continued on next page



P C I M S E R I E S

General Product Information	46
Technical Characteristics	47-48
Connector Outline Mating Dimensions	49
Code 3 Female - Straight Solder Connector and Straight Solder Connector with A.C. Pass-Through	50-52
Code 3 Male - Straight Solder Connector	53-54
Code 4 Female - Right Angle (90°) Board Mount Connector	55-58
Code 4 Male - Right Angle (90°) Board Mount Connector	59-62
Code 8 Female - Panel Mount Connector	63-64
Code 93 or 94 Female - Compliant Press-Fit Board Mount Connector and Compliant Press-Fit Board Mount Connector with A.C. Pass-Through	65-67
Code 93 or 94 Male - Compliant Press-Fit Board Mount Connector	68-69
Ordering Information	70

P C I B S E R I E S

General Product Information	71
Technical Characteristics	72
Connector Outline and Mating Dimensions	73
Code 3 Female - Straight Solder Connector and Straight Solder Connector with A.C. Pass-Through	74-75
Code 3 Male - Straight Solder Connector and Straight Solder Connector with Jackscrew System	76-77
Code 4 Female - Right Angle (90°) Board Mount Connector and Right Angle (90°) Board Mount Connector with A.C. Pass-Through	78-80
Code 4 Male - Right Angle (90°) Board Mount Connector	81-82
Code 8 Female - Panel Mount Connector and Panel Mount Connector with Jackscrew System	83-84
Code 93 or 94 Female - Compliant Press-Fit Board Mount Connector and Compliant Press-Fit Board Mount Connector with A.C. Pass-Through	85-86
Code 93 or 94 Male - Compliant Press-Fit Board Mount Connector and Compliant Press-Fit Board Mount Connector with Jackscrew System	87-88
Ordering Information	89

continued on next page



P C I C S E R I E S

General Product Information	90
Technical Characteristics	91
Connector Outline and Mating Dimensions	92
Code 3 Female - Straight Solder Connector and Straight Solder Connector with A.C. Pass-Through	93
Code 3 Male - Straight Solder Connector and Straight Solder Connector with Jackscrew System	94
Code 4 Female - Right Angle (90°) Board Mount Connector	95
Code 4 Male - Right Angle (90°) Board Mount Connector	96
Code 8 Female - Panel Mount Connector	97
Code 93 or 94 Female - Compliant Press-Fit Board Mount Connector, Compliant Press-Fit Board Mount Connector with A.C. Pass-Through and Compliant Press-Fit Board Mount Connector with Jackscrew System	98-99
Code 93 or 94 Male - Compliant Press-Fit Board Mount Connector	100
Ordering Information	101

R E M O V A B L E C O N T A C T S

Removable Contact Technical Characteristics	102
Size 22 Removable Crimp Contacts	102
Size 20 and Size 16 Removable Crimp Contacts	103

A P P L I C A T I O N T O O L S

Application Tools Introduction and Contact Reels For Automatic Pneumatic Crimp Tools	104
Compliant Press-Fit Connectors Printed Board Hole Sizes and Mounting Screws	105
Compliant Press-Fit Connector Installation Tools	106

S P E C I A L O P T I O N A P P E N D I X

Modification of Standard (MOS)	107-108
--	---------



Positronic
connectpositronic.com

PCI CONNECTION SYSTEMS

Compact
Power
Connectors

SYSTEM 1 MOTHER BOARD TO DAUGHTER BOARD

Female, Straight Solder or Press-fit Contacts

Typical part number: PCIH47F300A1
Currently available in: PCIH, PCIA, PCIM,
PCIB, PCIC

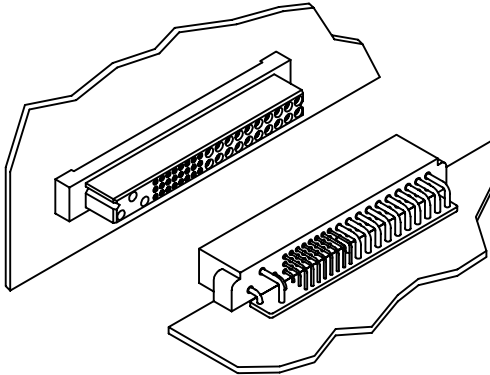

Male, Right Angle (90°) Contacts

Typical part number: PCIH47M400A1
Currently available in: PCIH, PCIA, PCIM,
PCIB, PCIC

Male, Straight Solder or Press-fit Contacts

Typical part number: PCIH47M300A1
Currently available in: PCIH and PCIA

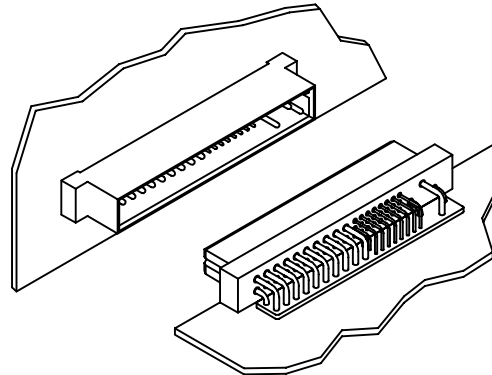

Female, Right Angle (90°) Contacts

Typical part number: PCIH47F400A1
Currently available in: PCIH, PCIA,
PCIM, PCIB, PCIC

SYSTEM 2 A.C. PASS-THROUGH TO RIGHT ANGLE (90°) BOARD MOUNT

Female, Straight Solder or Press-fit with AC Pass-Through Contacts Installed

Typical part number: PCIH47F300A1-246.0 with
FC112N2S-1565.0 (Ordered Separately)
Currently available in PCIC, PCIH, and PCIB.

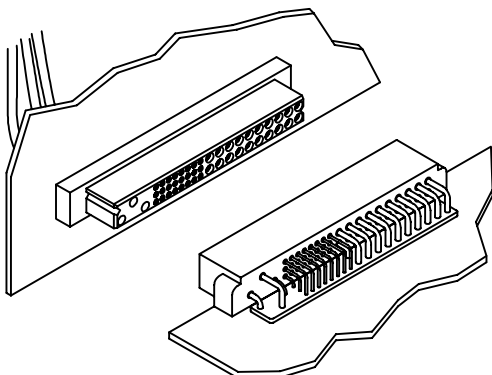

Male, Right Angle (90°) Contacts

Typical part number: PCIH47M400A1
Currently available in: PCIH, PCIA,
PCIM, PCIB, PCIC

SYSTEM 3 CABLE TO RIGHT ANGLE (90°) BOARD MOUNT

Female, Crimp Contacts Installed

Typical part number: PCIH47F8000 with
FC112N2S-1565.0 (Order Separately)
Currently available in PCIH, PCIA, PCIM, PCIB, PCIC

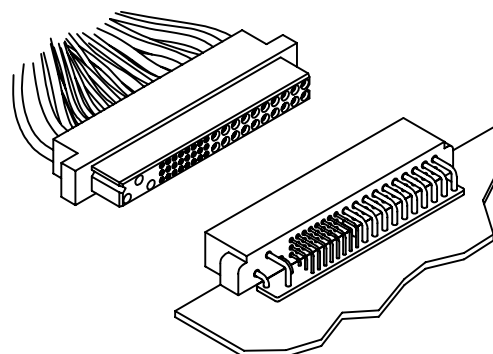

Male, Right Angle (90°) Contacts

Typical part number: PCIH47M400A1
Currently available in: PCIH, PCIA,
PCIM, PCIB, PCIC

SYSTEM 4

RIGHT ANGLE (90°) BOARD MOUNT TO RIGHT ANGLE (90°) BOARD MOUNT

Female, Right Angle (90°) Contacts

Typical part number: PCIH47F400A1

Currently available in: PCIH, PCIA, PCIM, PCIB, PCIC

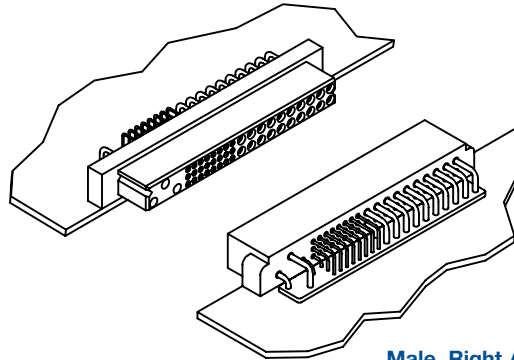

Male, Right Angle (90°) Contacts

Typical part number: PCIH47M400A1

Currently available in: PCIH, PCIA, PCIM, PCIB, PCIC

SYSTEM 5

RIGHT ANGLE (90°) BOARD MOUNT WITH A.C. PASS-THROUGH TO RIGHT ANGLE (90°) BOARD MOUNT

**Female, Right Angle (90°) with
AC Pass-Through Contacts Installed**

Typical part number: PCIH47F400A1-246.4 with
FC112N2S-1565.0 (Ordered Separately)

Currently available in: PCIH.

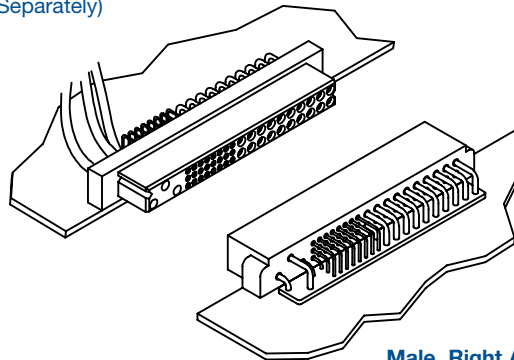

Male, Right Angle (90°) Contacts

Typical part number: PCIH47M400A1

Currently available in: PCIH, PCIA, PCIM, PCIB, PCIC



DEMYSTIFYING CURRENT RATINGS

Connector current ratings seem to be shrouded in mystery at times. The user wonders how a listed current rating is relevant to a particular application. Perhaps more mysterious is how similar connectors from various manufacturers list different current rating values. While it is true that material choices and design can enhance a connector's current rating, the test method by which the rating was developed must be understood when evaluations are made.

Users of connectors for power applications are entitled to current rating test details in order to make an informed choice. Ideally, a connector's current rating should be developed within the application for which it is being considered. Although ideal, this approach is not always practical given the many differing applications. In order for connector manufacturers to give potential product users an idea of what can be expected, connectors are given current ratings based on a specific test method.

A wide variety of test methods are employed in order to develop current ratings for connectors. Some of these methods come from standards that are recognized industry-wide, while others are unique to the manufacturer or user. These various test methods can produce different results for the same product. It is no wonder confusion sometimes results.

There are key factors that, when understood, can help in choosing the right power connector. All test methods used to rate current have similarities; however, there are variables in applying the test methods which explain differing results.

Current ratings are usually established by first developing a temperature rise curve. This curve plots temperature rise against increasing current levels. The curve is a reliable tool in understanding heat generation of the connector at various currents. When a defined failure is reached, the test ends. The highest current level achieved is usually listed as the current rating.

The temperature rise curve, and therefore the current rating, will change when certain key factors are varied.

These are:

- **Where is the temperature sensing probe placed?** *If placed on the contact in the mating area (the hottest spot), the results will be quite different than if placed on the outside of the connector body.*
- **Are the contacts being tested and rated in free air or are they contained within the connector housing?** *Contacts will obviously be cooler in free air.*
- **Are all of the contacts in the connector under load?** *If only part of the contacts are under load, the temperature rise could be less.*
- **What is the defined failure?** *Does the test end when the temperature rise reaches 30°C, 40°C, or some other number? Does it end when the temperature rise plus ambient temperature equal the operating limit of the connector housing? The current rating will be fixed by the defined failure point.*
- **How were the test samples prepared?** *Were the samples energized through a P.C. board? How many layers? How large were the traces? What was the weight of the copper? Were the samples energized through wire? What size was the wire? How long was the wire? Was the sample tested in static or forced air conditions? All of these factors can affect cooling characteristics.*

Clearly, a current rating value alone is not enough, and must be viewed in the context of the test used to develop the rating. When the test method is understood, evaluating and comparing power connectors for specific applications becomes much less of a mystery.



Tested per IEC Publication 60512-3, Test 5a

Test Detail: Curves were developed with all power contacts energized through 12 awg wire. Temperature rise was measured in the contact mating area. Test was conducted in static air.

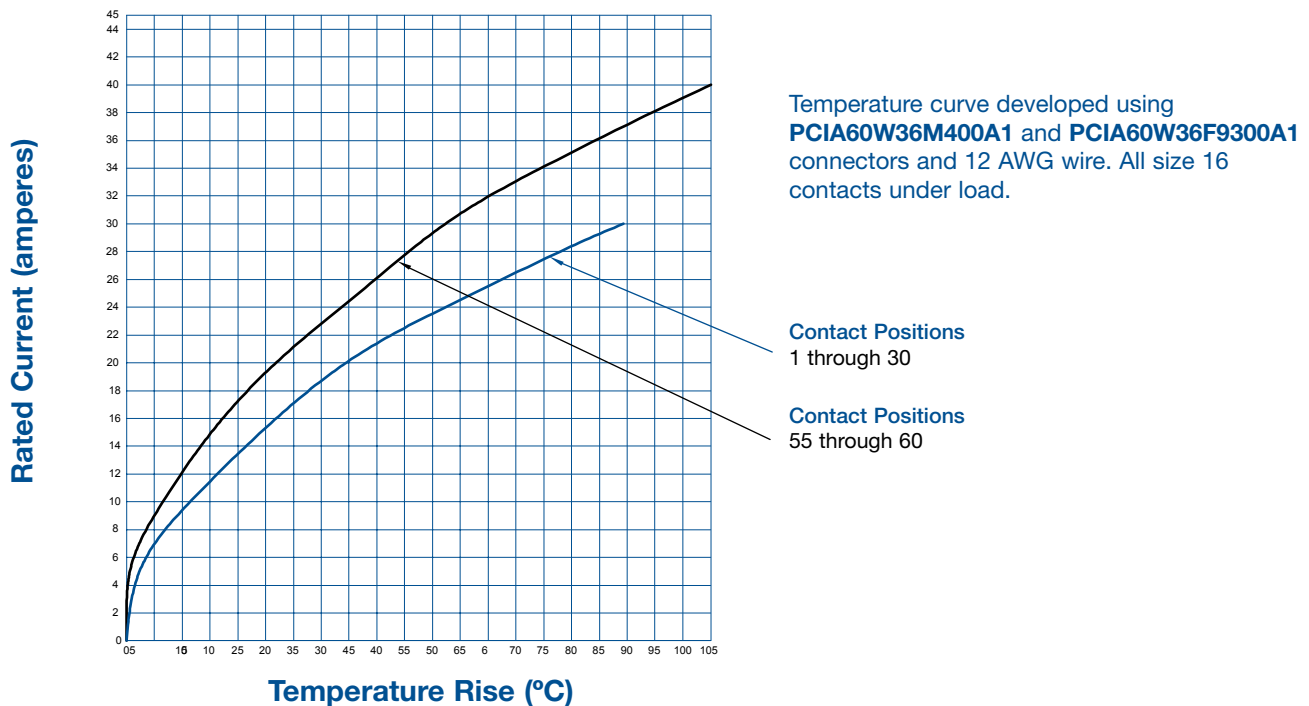
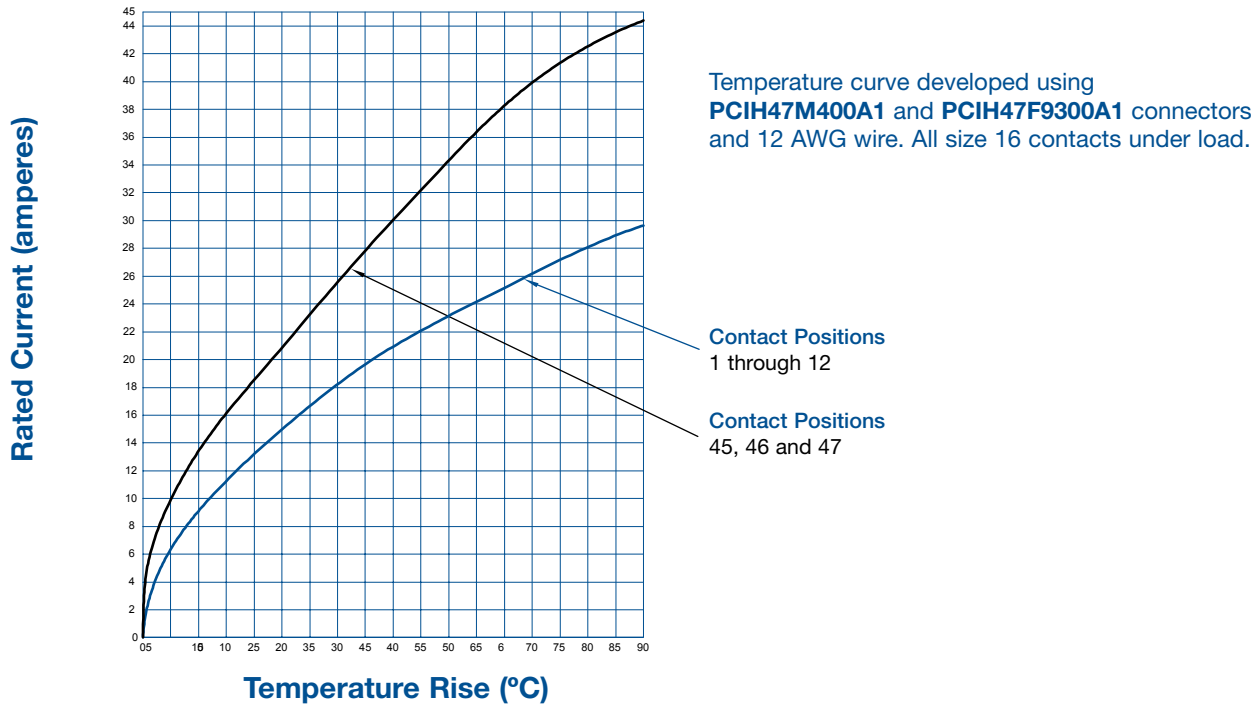



Positronic
connectpositronic.com

TEMPERATURE RISE CURVES

Compact
Power
Connectors

Tested per IEC Publication 60512-3, Test 5a

Test Detail: Curves were developed with all power contacts energized through 12 awg wire. Temperature rise was measured in the contact mating area. Test was conducted in static air.

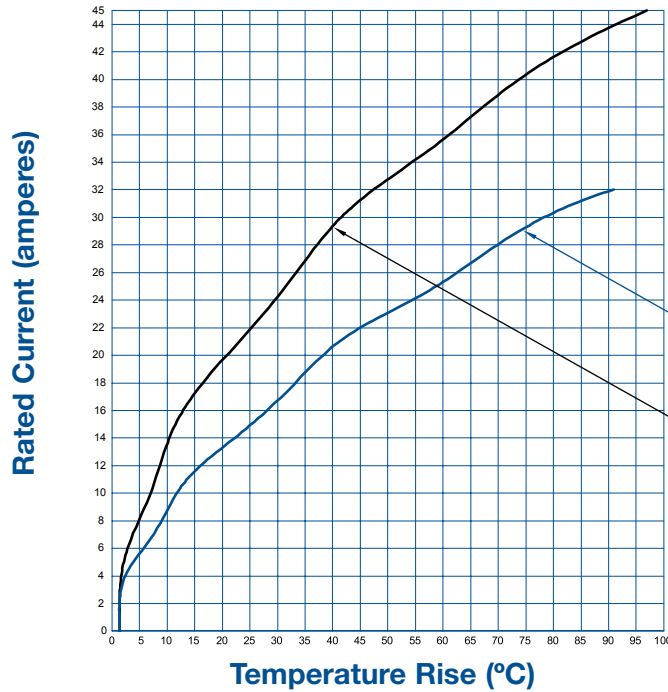

Temperature curve developed using **PCIM30W15M400A1** and **PCIM30W15F9300A1** connectors and 12 AWG wire. All size 16 contacts under load.

Contact Positions
1 through 12

Contact Positions
28 through 30

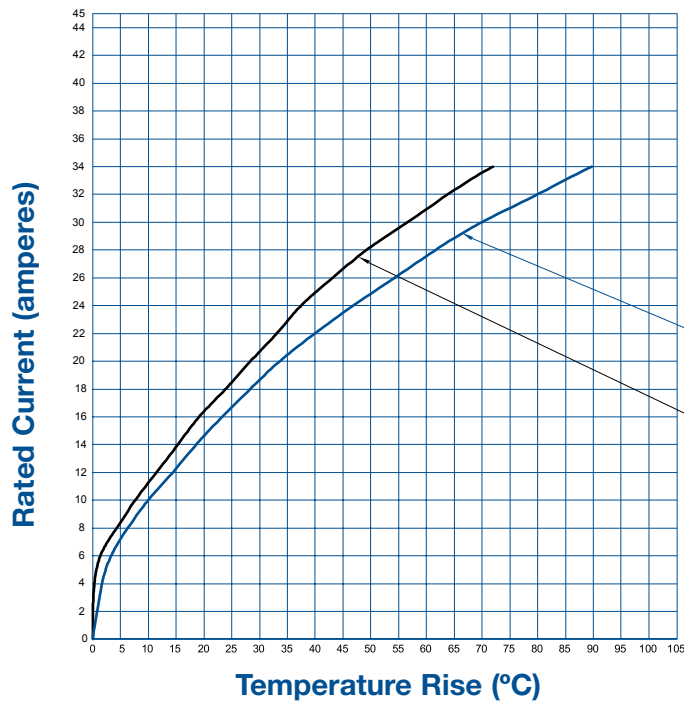

Temperature curve developed using **PCIB26W11M400A1** and **PCIB26W11F9300A1** connectors and 12 AWG wire. All size 16 contacts under load.

Contact Positions
1 through 12

Contact Positions
22 through 26

Tested per IEC Publication 60512-3, Test 5a

Test Detail: Curves were developed with all power contacts energized through 12 awg wire. Temperature rise was measured in the contact mating area. Test was conducted in static air.

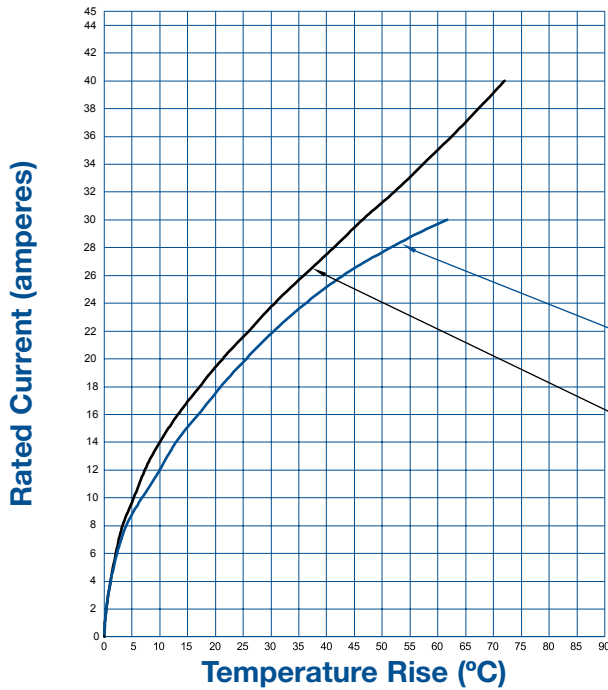

Temperature curve developed using **PCIC16W7M400A1** and **PCIC16W7F9300A1** connectors and 12 AWG wire. All size 16 contacts under load.

Contact Positions
1 through 4

Contact Positions
14 through 16

AC/DC INPUT KEYING

The PCIH49W25 variant has two more contacts than the PCIH47 variant, This provides an “electrical keying” for dedicated AC and DC inputs in a single connector (see below). This prevents damage to power supplies if mechanical keying fails or is not used. **Contacts can be depopulated as creepage and clearance requirements dictate.** It is also important to note that male versions of the PCIH47 will mate to female versions of the PCIH49W25.

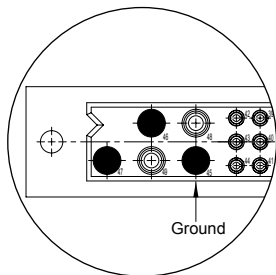

Dedicated AC Input

Position 45 - Ground
Positions 46, 47 - Line, Neutral
Positions 48, 49 - Depopulated, if required.

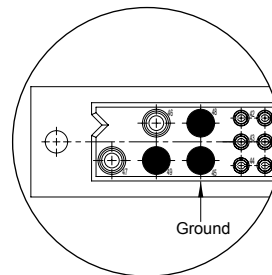

Dedicated DC Input

Position 45 - Ground (optional)
Positions 48, 49 - D.C. Input
Positions 46, 47 - Depopulated, if required.



Positronic
connectpositronic.com

A.C./D.C. INPUT KEYING

Compact
Power
Connectors

MECHANICAL KEYING

Mechanical keying is valuable for applications which offer A.C. or D.C. input power supplies. Inserting a D.C. input power supply into an A.C. slot can damage the power supply. Mechanical keying prevents this.

MATERIALS: Nylon

COLOR: White

MALE PLUG

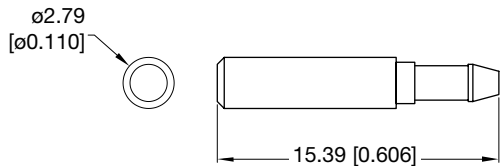

FEMALE PLUG

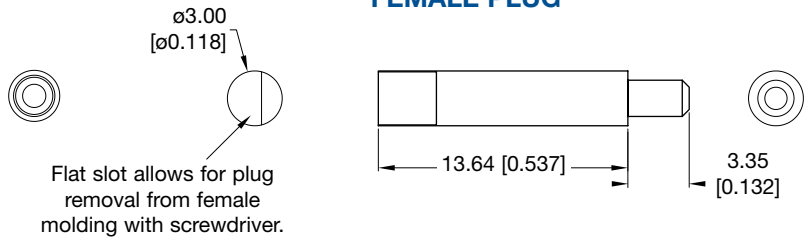

PART NUMBER 2703-16-0-0

To insert male plug use tool # 4311-0-0-0

PART NUMBER 2704-26-0-0

PCIH47 connectors can be ordered for use with keying plugs. Select base part number and add modifier -441.0 or -442.0 as described on page 107.

KEYED TO MATE

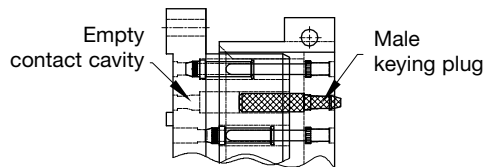

Keys can be placed in positions 48 and 49 to achieve keying.

KEYED TO BLOCK

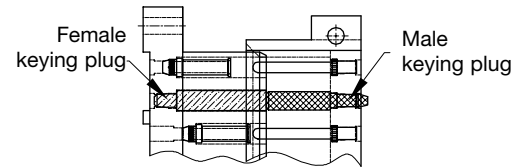

TYPICAL EXAMPLE FOR A.C. INPUT SUPPLIES

FEMALE

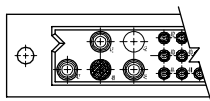

MALE

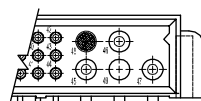

This example shows keying which allows A.C. input male connector to mate with A.C. input female connector. D.C. input male connector will not mate with A.C. input female connector.

TYPICAL EXAMPLE FOR D.C. INPUT SUPPLIES

FEMALE

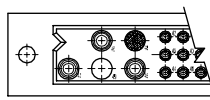

MALE

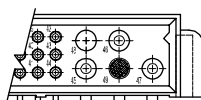

This example shows keying which allows D.C. input male connector to mate with D.C. input female connector. A.C. input male connector will not mate with D.C. input female connector.

NOTE: Once keying plugs are installed, they can be removed. To change keying sequence, remove installed plugs and insert **new** male and female keying plugs.

All PCI series utilize Positronic

LARGE SURFACE AREA CONTACT MATING SYSTEM

- Separates mechanical and electrical functions for superior performance
- Low contact resistance provides minimized voltage drop across the contact
- “Closed Entry” design prevents damage to female contacts and will not allow misaligned or bent contacts to enter
- Precision machined from solid, high conductivity copper alloy
- Uniform insertion/withdrawal forces through repeated mating cycles

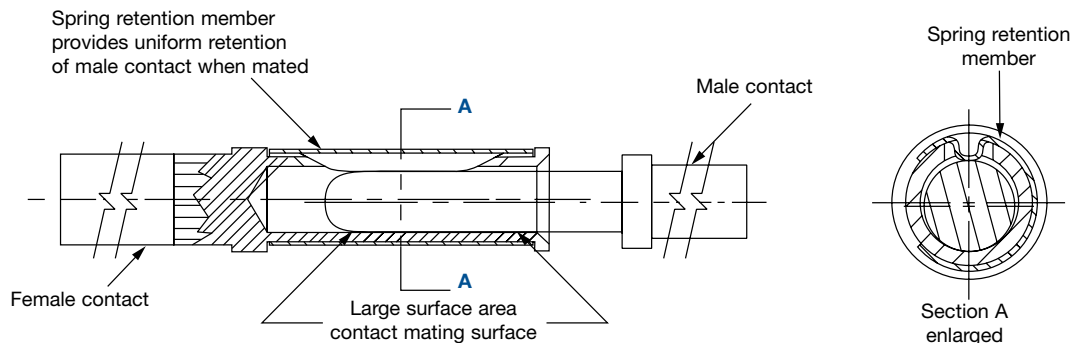

WHY IS THE L.S.A. SYSTEM SUPERIOR?

The primary function of connector contact is electrical conductivity. Also, a mechanical function is required to provide normal force between male and female contacts.

In order to provide for proper mechanical characteristics, material that has good memory or “elasticity” must be chosen. This will ensure contact normal force in a coupled condition and allow for repeated coupling and uncoupling.

Unfortunately, many materials that have good memory characteristics have low electrical conductivity. For instance, beryllium copper is a good choice for mechanical function; however, some beryllium copper alloys are poor conductors and have relatively low conductivity rates.

The conductivity path of many contact designs goes directly through materials that have been chosen based on mechanical need. If these materials have a low conductivity rating, increased contact resistance will result.

Positronic Large Surface Area Contact System separates the mechanical and electrical functions. A spring retention member provides normal forces, while the electrical conductivity path is through highly conductive contact material. See above detail.



Positronic
connectpositronic.com

COMPLIANT TERMINATIONS

Compact
Power
Connectors

POSITRONIC INDUSTRIES BI-SPRING POWER COMPLIANT TERMINATIONS

The Next Evolution In Compliant Technology. Fully Compliant, Fully Reliable.

Reliable, solderless connections from connectors to backplanes started with solid press-fit technology. Although these are still used today, concerns about board damage led to the use of compliant press-fit technology. This technology allows the connection to be made through compliance of the contact termination along with printed circuit board hole deformation. Although risk of damaged printed circuit boards and backplanes is lessened, damage can still occur due to

relatively high insertion and extraction forces.

The next step in press-fit technology is a highly reliable connection between the contact termination and backplane that is accomplished with reduced insertion and extraction forces. This eliminates risk of printed circuit board and backplane damage. This technology exists today with Positronic Bi-Spring Power Press-Fit termination.

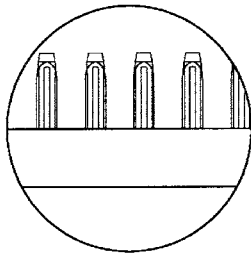

**Bi-Spring Power
Press-Fit Compliant
Terminations**

- Average insertion and extraction forces of size 16 contacts are 22N (5 lbs.) per contact and do not produce stresses in printed circuit boards and backplanes that can occur with higher insertion forces. These stresses can cause board warpage and hole damage.
- Connector systems utilizing Bi-Spring terminations use mounting screws to secure the connector to the printed circuit board or backplane. Stresses that occur during coupling, uncoupling or shock and vibration of systems are not transferred to the printed circuit boards or backplanes through the press-fit connection. The electrical integrity of the connector to board interface is maintained; this is particularly important in power applications. Bellcore GR1217 details a preference for mounting hardware when using press-fit terminations.
- Size 16 Bi-Spring terminations are designed to meet the performance requirements and hole diameters as listed in the internationally recognized specification IEC 60352-5.
- Lower insertion and extraction forces eliminate the need for expensive pressing equipment.

OMEGA SIGNAL LEVEL COMPLIANT TERMINATIONS

Today's power supplies feature communication options with the host system. The power interface must have reliable signal level connections.

Positronic Omega Press-Fit terminations are the perfect solderless connection companion to the Bi-Spring Power Press-Fit terminations.

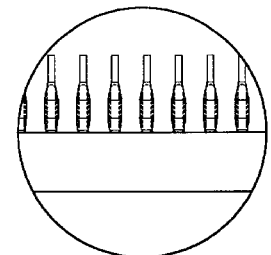

**Omega Signal Level
Press-Fit Compliant
Terminations**

Patent No. 6,260,268



The Compact Power Connector Series design allows for the development of application specific contact arrangements in a timely manner and at a reasonable price. After reviewing the following basic information, contact Technical Sales with your current, voltage, and safety requirements. We look forward to working with you to develop a connector for your specific needs.

BASIC CONNECTOR DIMENSIONS

RIGHT ANGLE (90°) BOARD MOUNT CONNECTOR

MALE CONNECTOR

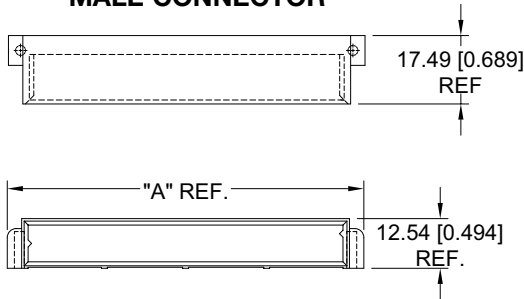

FEMALE CONNECTOR

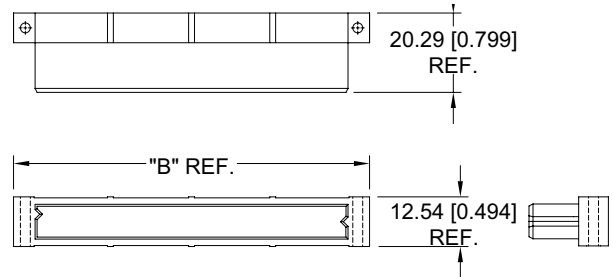

STRAIGHT BOARD MOUNT CONNECTOR

MALE CONNECTOR

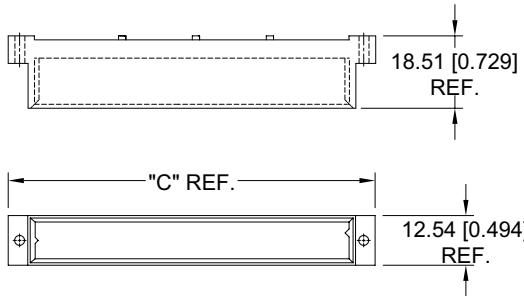

FEMALE CONNECTOR

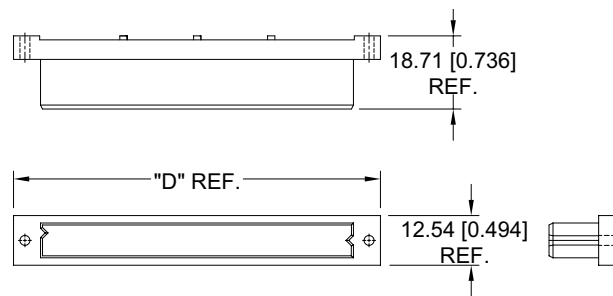

FOUR CONTACT SIZES TO CHOOSE FROM

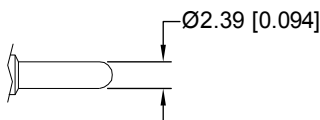

Size 12 contact

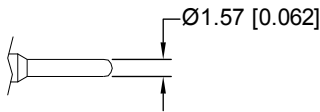

Size 16 contact

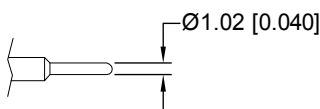

Size 20 contact

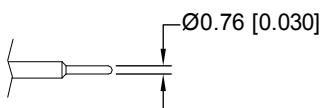

Size 22 contact

Contact sizes may be mixed within a single connector.

BASIC SERIES	"A"	"B"	"C"	"D"
PCIH	91.03 [3.584]	91.04 [3.584]	93.82 [3.694]	93.82 [3.694]
PCIA	116.53 [4.588]	120.90 [4.760]	119.32 [4.698]	119.32 [4.698]
PCIB	53.54 [2.108]	53.54 [2.108]	N/A	56.32 [2.217]
PCIC	43.96 [1.731]	43.96 [1.731]	N/A	46.74 [1.840]
PCIM	69.66 [2.743]	69.66 [2.743]	N/A	72.44 [2.852]

MANY TERMINATION TYPES CAN BE SUPPLIED

- Straight Solder or Compliant Press-Fit
- Right Angle (90°) Solder
- Crimp Removable
- Different termination types can be mixed within a single connector

POPULAR OPTIONS

- Sequential Mating
- Recessed Female Contacts
- Selective Loading



Why Pay For More Than You Need?

The current carrying capability of the Compact Power Connector is considerable. In many applications a customer may be paying for unused capacity if a fully loaded connector is used. Connectors are available with fewer power contacts loaded to allow for a cost savings.

The **PICMG® 2.11 Power Interface Specification** allows for three loading options of male contact, right angle (90°), free board connectors. Female contact fixed board connectors may not be selectively loaded. Consult PICMG 2.11 for details.

	Output Contact Position Loaded*	Total Output Contacts*	Positronic Part Number
Option 1	1,3,4,5,6,7,8,9,11,12,13,15,16,17,19,20	16	PCIH47M400A1-259.2
Option 2	1,4,5,8,9,12,13,16,19,20	10	PCIH47M400A1-259.0
Option 3	1,5,9,13,19,20	6	PCIH47M400A1-259.1

* All input and signal contact positions are loaded.

Additional savings can be gained when female contact connectors are supplied selectively loaded for applications not specific to PICMG® 2.11.

PCI INVERTED TERMINATION OPTIONS

FEMALE CONNECTORS

AVAILABLE IN
PCIH, PCIA, PCIM, PCIB, PCIC

MALE CONNECTORS

AVAILABLE IN
PCIH, PCIM, PCIB, PCIC

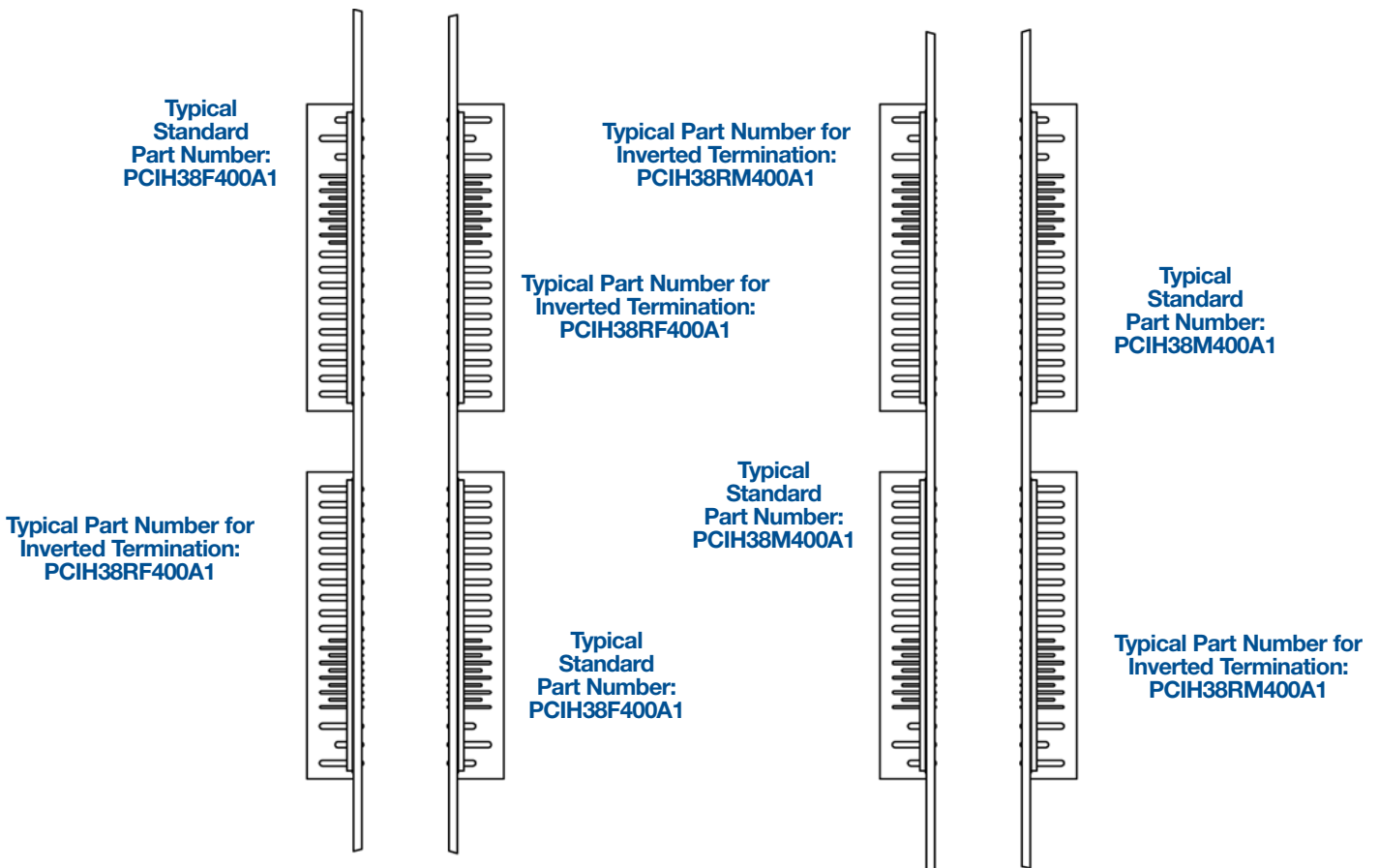

Inverted termination options allow flexibility in positioning the connector as best suited for specific applications.



The **PCIH** series was developed specifically for use with **CompactPCI®** in-rack modular power supplies. The package size is ideal for use in all 3U and 6U based platforms. The PCIH series is an excellent choice in **IEEE 1101.1**, **IEEE 1101.10**, and **VITA 30** applications where system power requirements have exceeded the capabilities of commonly used power connectors.

The **PCIH47** variant is fully compliant to the **PICMG® 2.11 Power Interface Specification**. This Specification details standardized power for use with **CompactPCI®** systems. Visit www.picmg.com for details.

PCIH SERIES CONTACT VARIANTS

FACE VIEW OF MALE AND REAR VIEW OF FEMALE

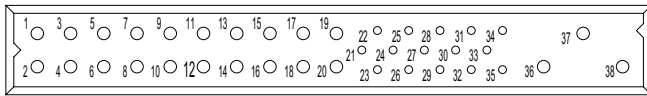

PCIH38 VARIANT

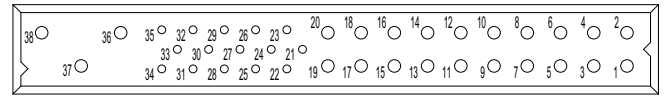

PCIH38R VARIANT (Inverted Termination)

23 Size 16 Power Contacts and 15 Size 20 Signal Contacts

CompactPCI®

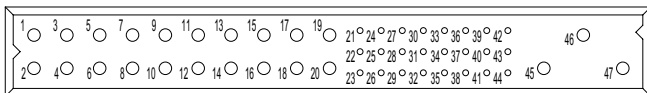

PCIH47 VARIANT

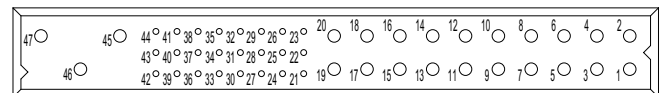

PCIH47R VARIANT (Inverted Termination)

23 Size 16 Power Contacts and 24 Size 22 Signal Contacts

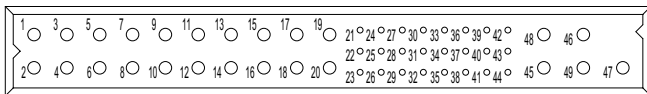

PCIH49W25 VARIANT

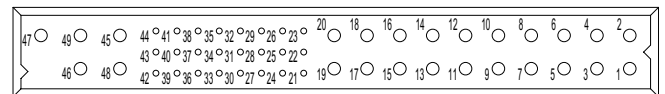

PCIH49W25R VARIANT

25 Size 16 Power Contacts and 24 Size 22 Signal Contacts



MATERIALS AND FINISHES:

Insulator:	Glass-filled polyester, UL 94V-0, blue color.
Contacts:	Size 16 contacts: High conductivity precision-machined copper alloy. Size 20 and 22 contacts: Precision-machined copper alloy.
Plating:	gold flash over nickel. Other plating options available, refer to Step 7 on page 36.
Mounting Screws:	Steel, zinc plated.

ELECTRICAL CHARACTERISTICS:

PCIH Contact Current Ratings, per UL 1977

See Temperature Rise Curves on page 4 for details.

PCIH38:

Size 16 Power Contacts: Positions 36, 37, and 38:	40 amperes continuous, all contacts under load.
Positions 1 - 20:	28 amperes continuous, all contacts under load.
Size 20 Signal Contacts:	5 amperes nominal rating.

PCIH47:

Size 16 Power Contacts: Positions 45, 46, and 47:	40 amperes continuous, all contacts under load.
Positions 1 - 20:	28 amperes continuous, all contacts under load.
Size 22 Signal Contacts:	3 amperes nominal rating.

PCIH49:

Size 16 Power Contacts: Positions 45 through 49:	37 amperes continuous, all contacts under load.
Positions 1 - 20:	28 amperes continuous, all contacts under load.
Size 22 Signal Contacts:	3 amperes nominal rating.

Initial Contact Resistance; maximum:

Size 16 Contact:	0.0007 ohms maximum.
Size 20 Contact:	0.004 ohms maximum.
Size 22 Contact:	0.005 ohms maximum. Per IEC 512-2, Test 2b.

Insulator Resistance:	5 G ohms per IEC 512-2, Test 3a.
------------------------------	----------------------------------

Voltage Proof:

PCIH38:

Contacts 36, 37 and 38:	3,000 V r.m.s.
Contacts 1 through 20:	1,500 V r.m.s.
Contacts 21 through 35:	1,000 V r.m.s.

PCIH47:

Contacts 45, 46, and 47:	3,000 V r.m.s.
Contacts 1 through 20:	1,500 V r.m.s.
Contacts 21 through 44:	1,000 V r.m.s.

PCIH49:

Contacts 1 through 20:	1,500 V r.m.s.
Contacts 45 through 49:	1,500 V r.m.s.
Contacts 21 through 44:	1,000 V r.m.s.

Creepage and Clearance Distance; minimum:

PCIH38:

Contact 38 to Contact 36:	3.2mm [0.126 inch]
Contact 37 to Contact 36:	3.2mm [0.126 inch]
Contact 38 to Signal Contacts:	6.4mm [0.252 inch]
Contact 37 to Signal Contacts:	6.4mm [0.252 inch]
Contact 38 to Contact 37:	2.5mm [0.098 inch]
Contact 36 to Signal Contacts:	2.0mm [0.079 inch]

PCIH47:

Contact 47 to Contact 45:	3.2mm [0.126 inch]
Contact 46 to Contact 45:	3.2mm [0.126 inch]
Contact 47 to Signal Contacts:	6.4mm [0.252 inch]
Contact 46 to Signal Contacts:	6.4mm [0.252 inch]
Contact 47 to Contact 46:	2.5mm [0.098 inch]
Contact 45 to Signal Contacts:	2.0mm [0.079 inch]
Contact 36 to Signal Contacts:	2.0mm [0.079 inch]

Working Voltage:

PCIH38:

Contacts 36, 37 and 38:	1,000 V r.m.s.
Contacts 1 through 20:	500 V r.m.s.
Contacts 21 through 35:	333 V r.m.s.

PCIH47:

Contacts 45, 46, and 47:	1,000 V r.m.s.
Contacts 1 through 20:	500 V r.m.s.
Contacts 21 through 44:	333 V r.m.s.

PCIH49:

Contacts 1 through 20:	500 V r.m.s.
Contacts 45 through 49:	500 V r.m.s.
Contacts 21 through 44:	333 V r.m.s.

MECHANICAL CHARACTERISTICS:

Blind Mating System:

Male and female connector bodies provide "lead-in" for 1.3 mm [0.050 inch] diametral misalignment.

Polarization:

Provided by connector body design.

Removable Contacts:

Install contact from rear of insulator; release from front of insulator. Size 16, 20 and 22 female contacts feature "Closed Entry" design for highest reliability.

Removable Contact Retention in Connector Body:

Size 16 Contacts:	67 N [15 lbs.]
Size 20 Contacts:	45 N [10 lbs.]
Size 22 Contacts:	27 N [6 lbs.]

Fixed Contacts:

Printed board terminations, both straight and right angle (90°). Size 16 female contacts feature "Closed Entry" design. Size 20 and 22 feature rugged "Open Entry" contact design. "Closed Entry" contacts available, consult Technical Sales.



**Fixed Contact Retention
in Connector Body:**

Size 16 Contacts: 45 N [10 lbs.]
Size 20 and 22 Contacts: 27 N [6 lbs.]

Resistance to Solder Heat:

260°C [500°F] for 10 seconds
duration per IEC 512-6, Test
12e, 25-watt soldering iron.

Sequential Contact Mating System:

PCIH38: First mate contact 36 and last
mate contact positions 22, 25
and 28.

**PCIH47 and
PCIH49 with MOS:** First mate contact 45 and last
mate contact position 27.

Consult Technical Sales for customer specified sequential mating.

**Safety "Recessed in
Insulator" Contacts:**

The following size 16 contacts
are recessed 5mm [0.197 inch]
below the face of the female
connector insulator per safety
requirements.

PCIH38: Contact positions 37 and 38.

**PCIH47 and
PCIH49 with MOS:** Contact positions 46 and 47.

Compliant Terminations:

Size 16, 20 and 22 contacts
are available with compliant
contact terminations. Average
insertion and extraction forces
of size 16 contacts are
22N (5 lbs.) per contact.

**Printed Board
and Panel Mounting:**

Mounting holes provided in
connector body for both printed
board and panel mounting.
Self-tapping screws are
available.

Mechanical Operations:

250 couplings, minimum.

CLIMATIC CHARACTERISTICS:

Working Temperature: -55°C to +125°C.

**U.L. Recognized File #E49351
CSA Recognized File #LR54219
TUV Recognized File #215/99**

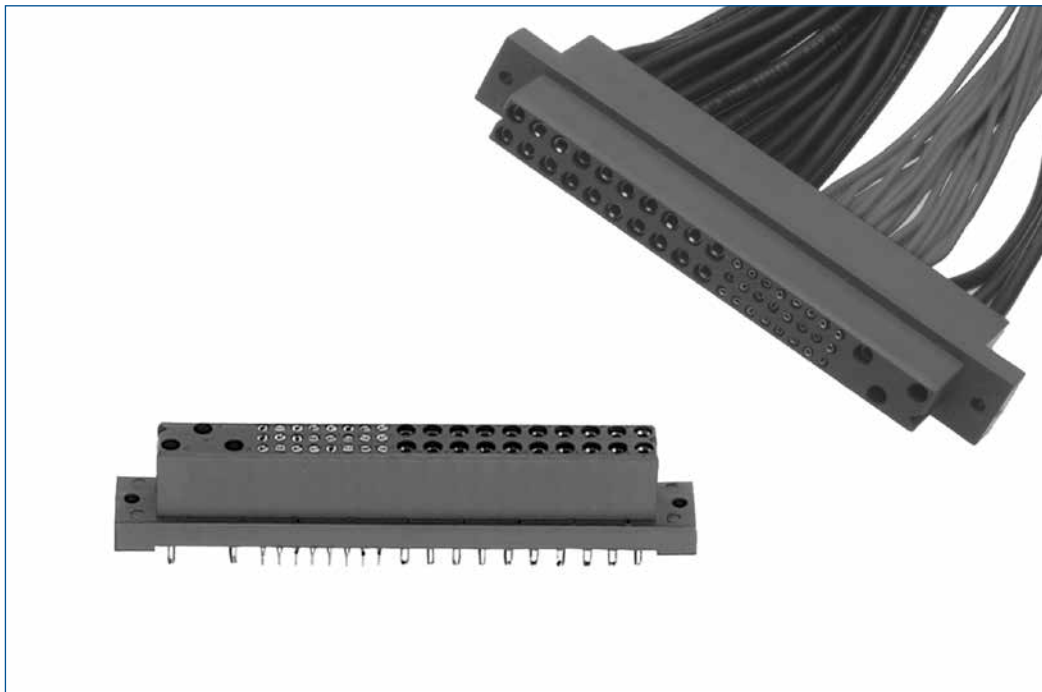



PCIH CONNECTOR OUTLINE DIMENSIONS

RIGHT ANGLE (90°) BOARD MOUNT CONNECTOR

MALE CONNECTOR

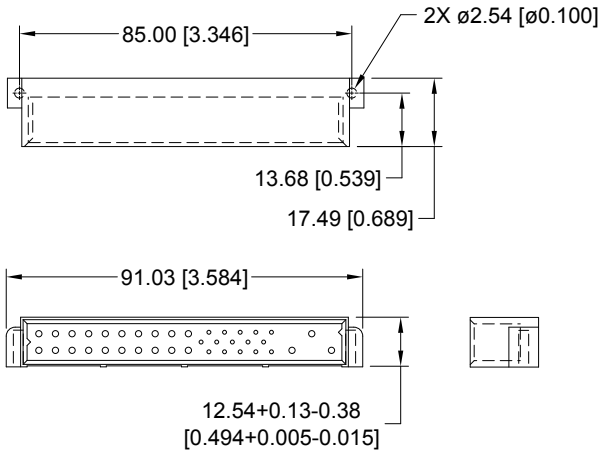

FEMALE CONNECTOR

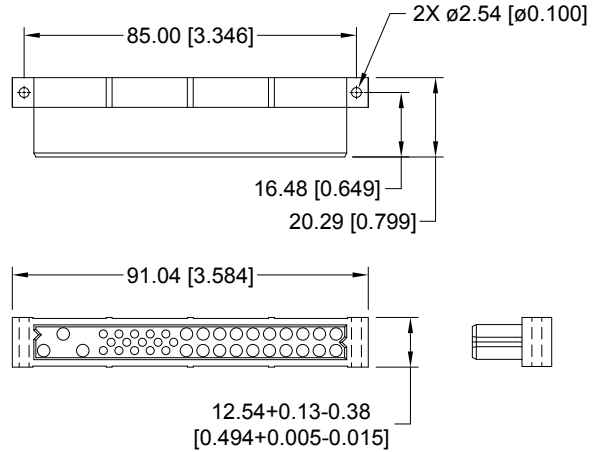

STRAIGHT BOARD MOUNT CONNECTOR

MALE CONNECTOR

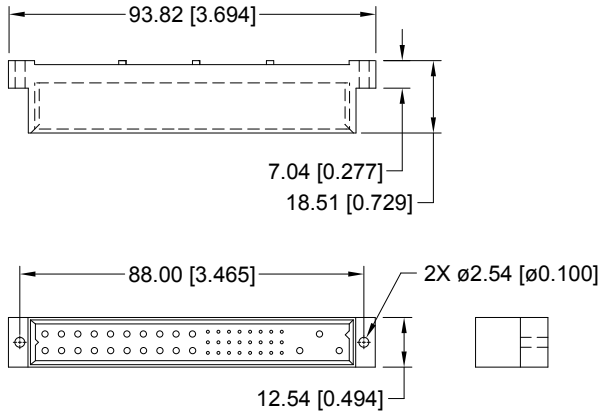

FEMALE CONNECTOR

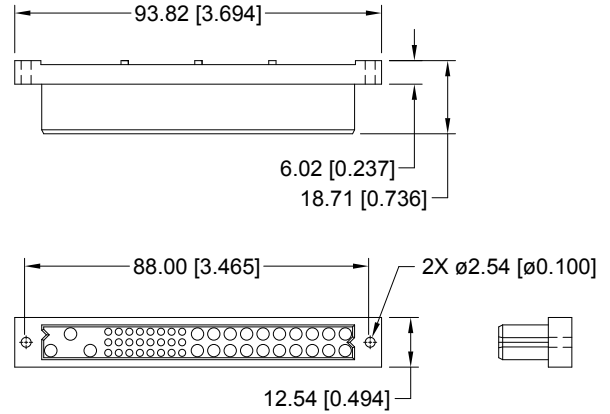

PCIH CONNECTOR MATING DIMENSIONS

(FULLY MATED)

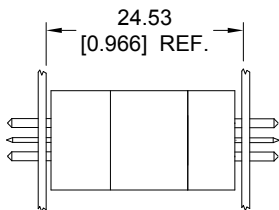

**Straight Board
Mount Male to Straight
Board Mount or Panel
Mount Female**

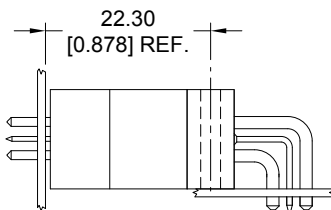

**Straight Board
Mount Male to
Right Angle (90°)
Board Mount Female**

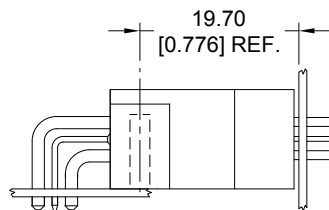

**Right Angle (90°) Board
Mount Male to Straight
Board Mount or Panel
Mount Female**

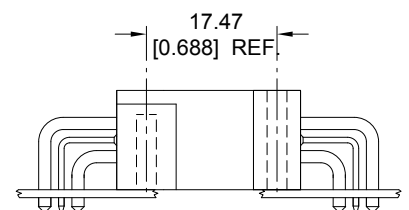

**Right Angle (90°)
Board Mount Male to
Right Angle (90°)
Board Mount Female**

FEMALE STRAIGHT SOLDER CONNECTOR CODE 3

STANDARD PART NUMBER
PCIH38F300A1

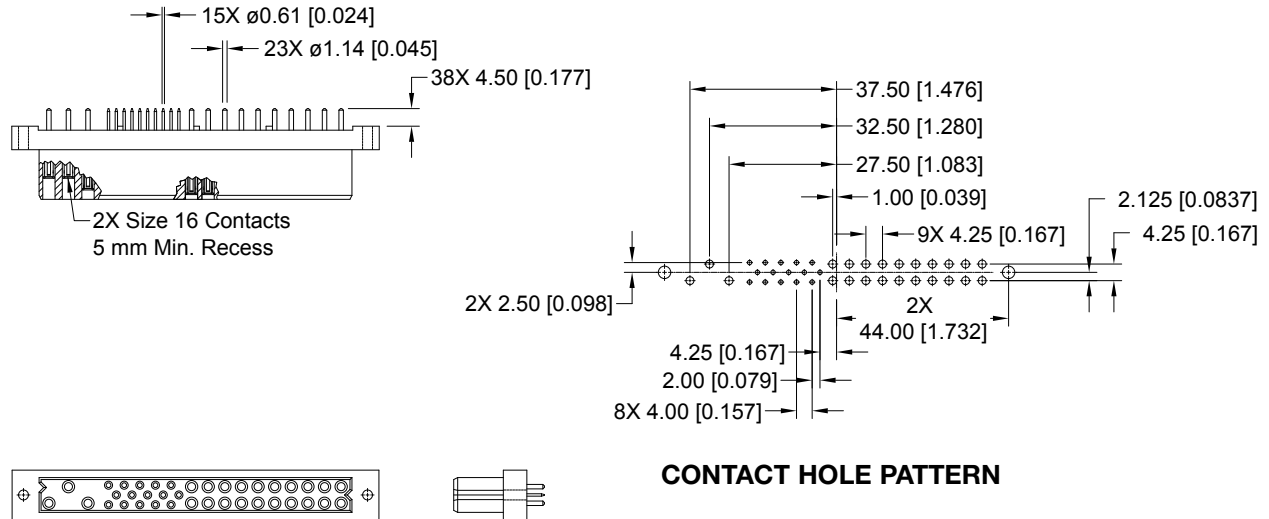

CONNECTOR DIMENSIONS

Note: See below for suggested printed board hole sizes.

FEMALE STRAIGHT SOLDER CONNECTOR WITH A.C. PASS-THROUGH CODE 3 WITH MOS* -245.0

CRIMP CONTACTS ARE NOT SUPPLIED WITH CONNECTOR AND MUST BE ORDERED SEPARATELY

HIGH PROFILE PART NUMBER
PCIH38F300A1-245.0

* For MOS descriptions,
see chart on pages 107-108.

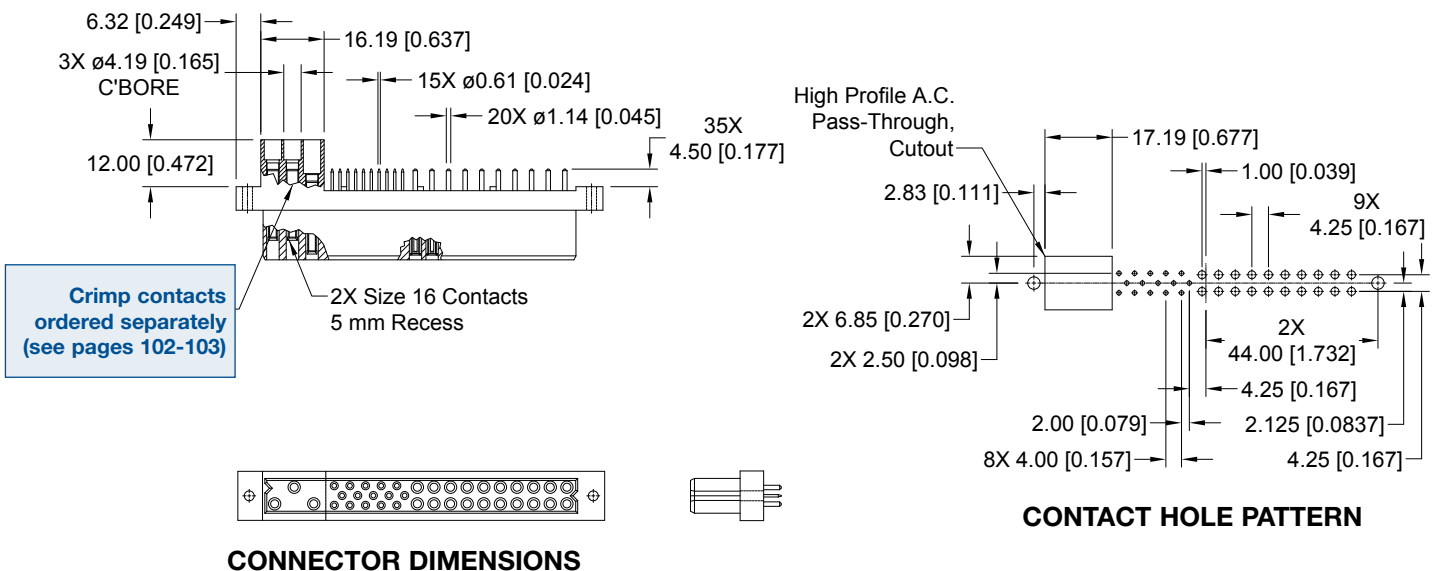

CONNECTOR DIMENSIONS

CONTACT HOLE PATTERN

SUGGESTED PRINTED BOARD HOLE SIZES:

- Suggest $\varnothing 1.00$ [0.039] holes for size 20 and size 22 contact holes.
- Suggest $\varnothing 1.60$ [0.063] holes for size 16 contact holes.
- Suggest $\varnothing 3.56 \pm 0.08$ [0.140 \pm 0.003] holes for connector mounting holes.



STRAIGHT SOLDER CONNECTOR, FEMALE

FEMALE STRAIGHT SOLDER CONNECTOR WITH A.C. PASS-THROUGH CODE 3 WITH MOS* -246.1

CRIMP CONTACTS ARE NOT SUPPLIED WITH CONNECTOR AND MUST BE ORDERED SEPARATELY

LOW PROFILE PART NUMBER
PCIH38F300A1-246.1

* For MOS descriptions,
see chart on pages 107-108.

Crimp contacts
ordered separately
(see pages 102-103)

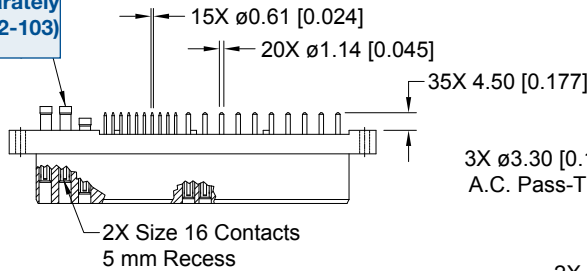

CONNECTOR DIMENSIONS

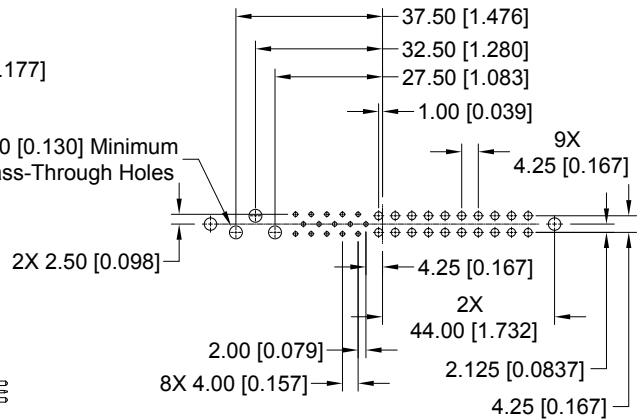

CONTACT HOLE PATTERN

Note: See below for suggested printed board hole sizes.

FEMALE STRAIGHT SOLDER CONNECTOR CODE 3

STANDARD PART NUMBER
PCIH47F300A1

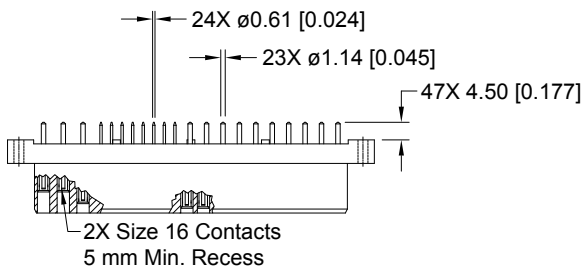

CONNECTOR DIMENSIONS

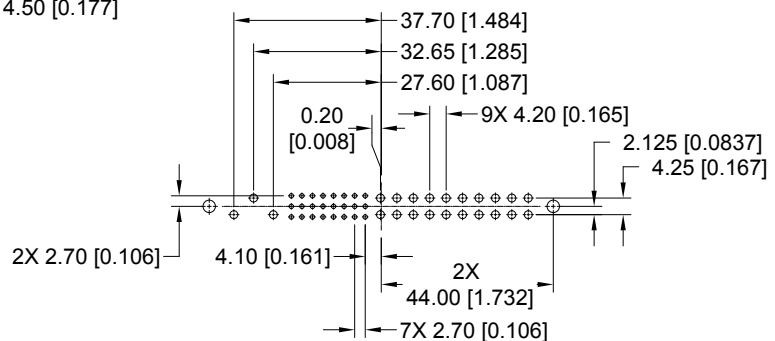

CONTACT HOLE PATTERN

SUGGESTED PRINTED BOARD HOLE SIZES:

Suggest Ø1.00 [0.039] holes for size 20 and size 22 contact holes.

Suggest Ø1.60 [0.063] holes for size 16 contact holes.

Suggest Ø3.56±0.08 [0.140±0.003] holes for connector mounting holes.

FEMALE STRAIGHT SOLDER CONNECTOR WITH A.C. PASS-THROUGH CODE 3 WITH MOS* -246.0

CRIMP CONTACTS ARE NOT SUPPLIED WITH CONNECTOR AND MUST BE ORDERED SEPARATELY

LOW PROFILE PART NUMBER
PCIH47F300A1-246.0

* For MOS descriptions,
see chart on pages 107-108.

Crimp contacts
ordered separately
(see pages 102-103)

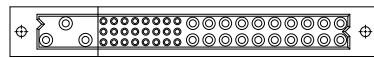
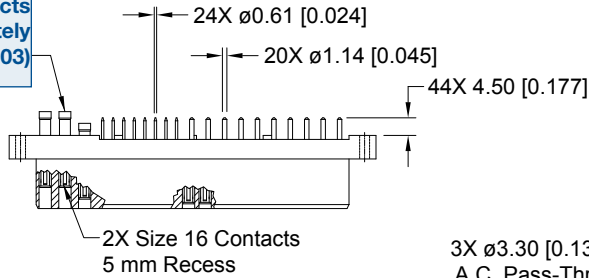

CONNECTOR DIMENSIONS

3X $\varnothing 3.30$ [0.130] Minimum
A.C. Pass-Through Holes

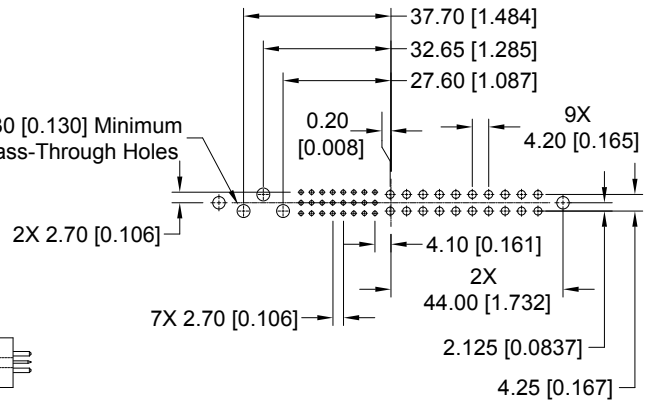

CONTACT HOLE PATTERN

Note: See below for suggested printed board hole sizes.

FEMALE STRAIGHT SOLDER CONNECTOR WITH A.C. PASS-THROUGH CODE 3 WITH MOS* -246.3

CRIMP CONTACTS ARE NOT SUPPLIED WITH CONNECTOR AND MUST BE ORDERED SEPARATELY

LOW PROFILE PART NUMBER
PCIH49W25F300A1-246.3

* For MOS descriptions,
see chart on pages 107-108.

Crimp contacts
ordered separately
(see pages 102-103)

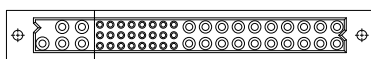
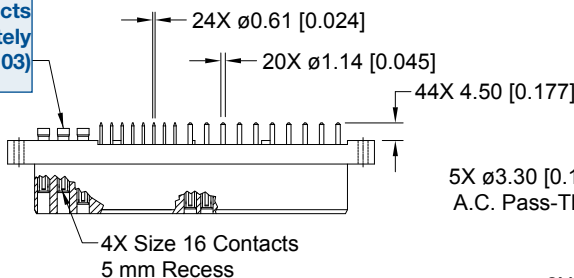

CONNECTOR DIMENSIONS

5X $\varnothing 3.30$ [0.130] Minimum
A.C. Pass-Through Holes

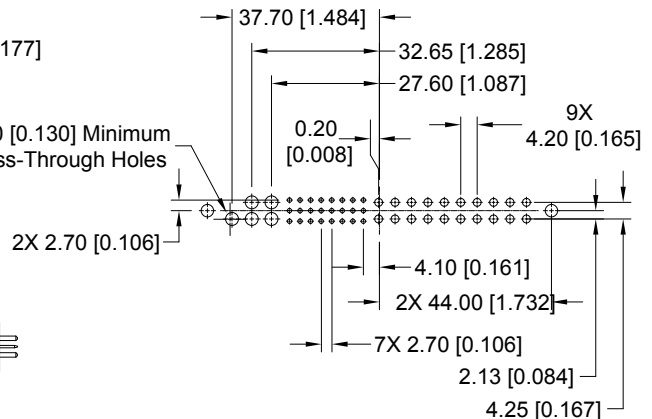

CONTACT HOLE PATTERN

SUGGESTED PRINTED BOARD HOLE SIZES:

Suggest $\varnothing 1.00$ [0.039] holes for size 20 and size 22 contact holes.

Suggest $\varnothing 1.60$ [0.063] holes for size 16 contact holes.

Suggest $\varnothing 3.56 \pm 0.08$ [0.140 \pm 0.003] holes for connector mounting holes.

DIMENSIONS ARE IN MILLIMETERS [INCHES].
ALL DIMENSIONS ARE SUBJECT TO CHANGE.



FEMALE STRAIGHT SOLDER CONNECTOR CODE 3 WITH MOS* -379.0

STANDARD PART NUMBER
PCIH49W25F300A1-379.0

* For MOS descriptions,
see chart on pages 107-108.

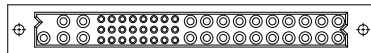
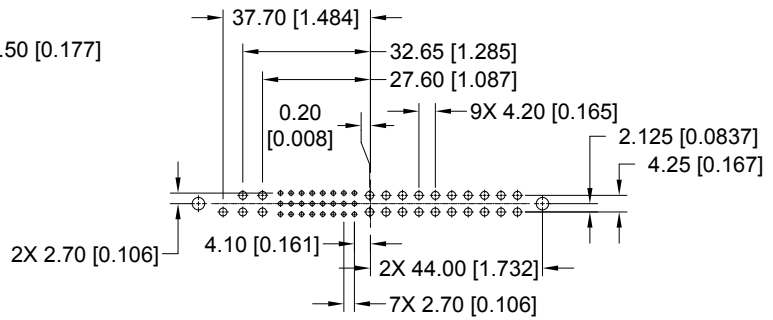
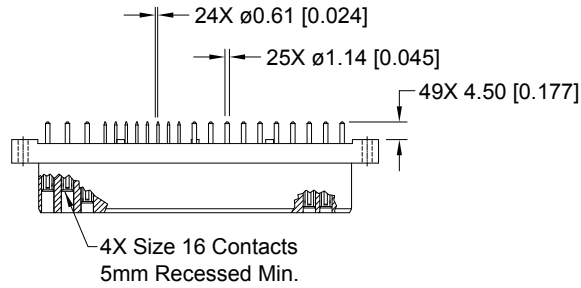

CONNECTOR DIMENSIONS

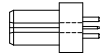

CONTACT HOLE PATTERN

SUGGESTED PRINTED BOARD HOLE SIZES:

- Suggest $\varnothing 1.00$ [0.039] holes for size 20 and size 22 contact holes.
- Suggest $\varnothing 1.60$ [0.063] holes for size 16 contact holes.
- Suggest $\varnothing 3.56 \pm 0.08$ [0.140 \pm 0.003] holes for connector mounting holes.

**MALE STRAIGHT SOLDER CONNECTOR
CODE 3**

**STANDARD PART NUMBER
PCIH38M300A1**

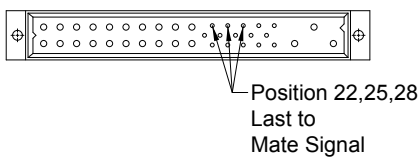
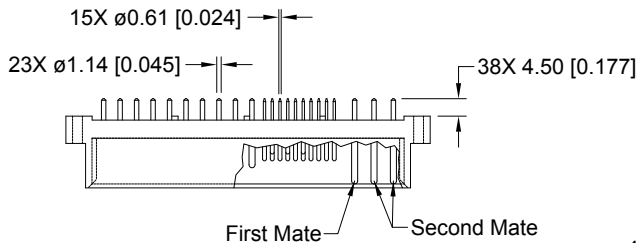

CONNECTOR DIMENSIONS

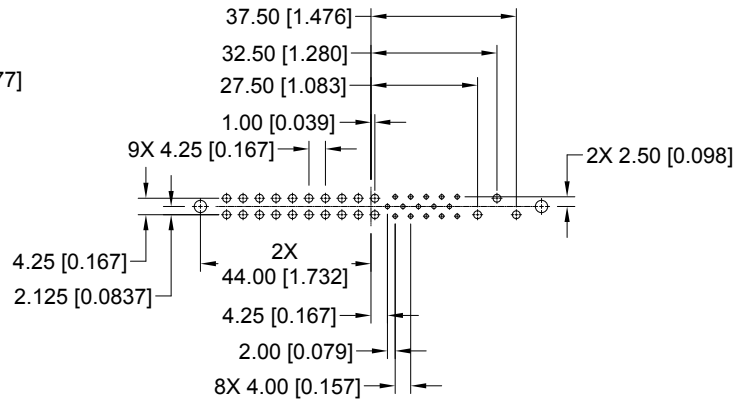

CONTACT HOLE PATTERN

Note: See below for suggested printed board hole sizes.

PCIH SERIES

**MALE STRAIGHT SOLDER CONNECTOR
CODE 3**

**STANDARD PART NUMBER
PCIH47M300A1**

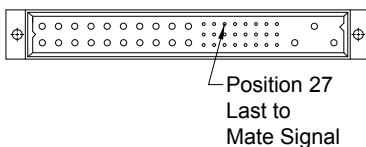
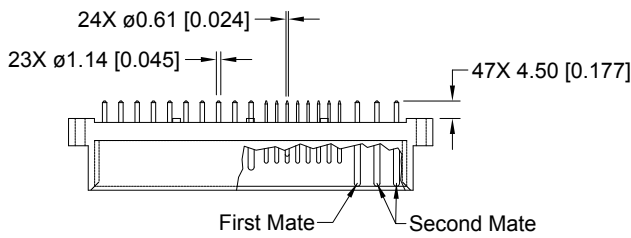

CONNECTOR DIMENSIONS

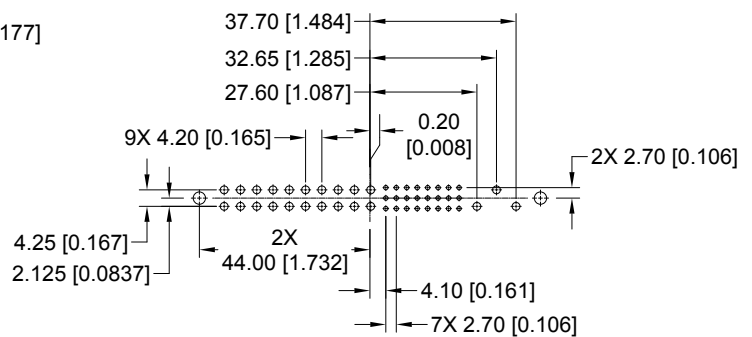

CONTACT HOLE PATTERN

SUGGESTED PRINTED BOARD HOLE SIZES:

Suggest Ø1.00 [0.039] holes for size 20 and size 22 contact holes.
Suggest Ø1.60 [0.063] holes for size 16 contact holes.
Suggest Ø3.56±0.08 [0.140±0.003] holes for connector mounting holes.



MALE STRAIGHT SOLDER CONNECTOR CODE 3 WITH MOS* -378.0

STANDARD PART NUMBER
PCIH49W25M300A1-378.0

* For MOS descriptions,
see chart on pages 107-108.

PCIH SERIES

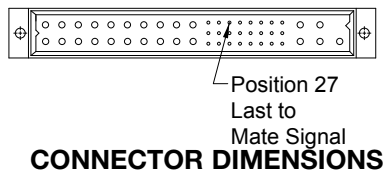
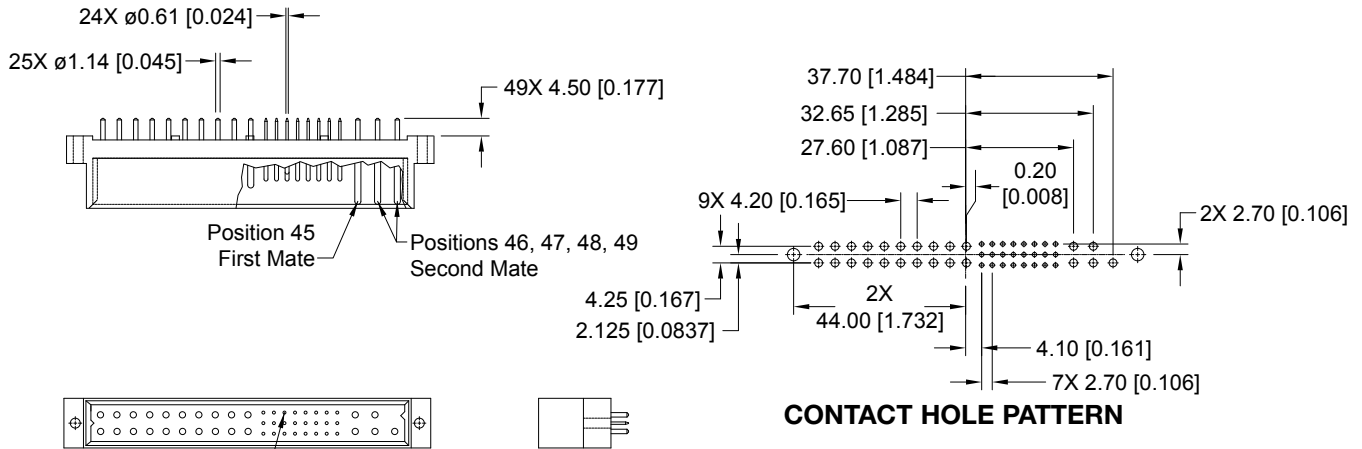

CONTACT HOLE PATTERN

SUGGESTED PRINTED BOARD HOLE SIZES:

- Suggest $\varnothing 1.00$ [0.039] holes for size 20 and size 22 contact holes.
- Suggest $\varnothing 1.60$ [0.063] holes for size 16 contact holes.
- Suggest $\varnothing 3.56 \pm 0.08$ [0.140 \pm 0.003] holes for connector mounting holes.

**FEMALE RIGHT ANGLE (90°) BOARD MOUNT CONNECTOR
CODE 4**

**STANDARD PART NUMBER
PCIH38F400A1**

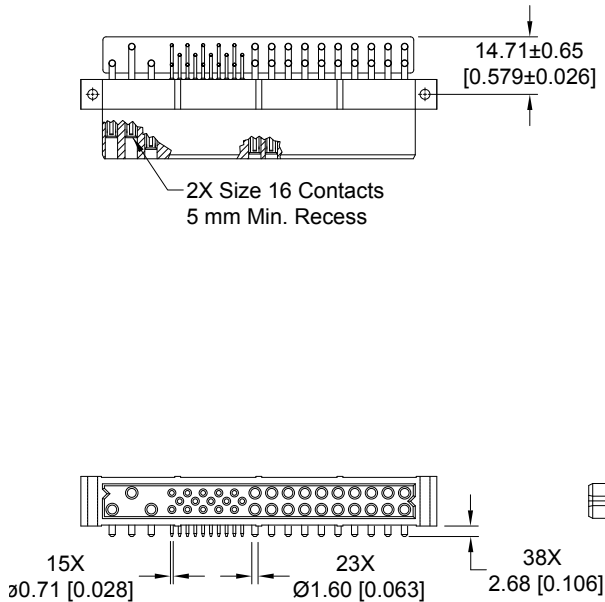

CONNECTOR DIMENSIONS

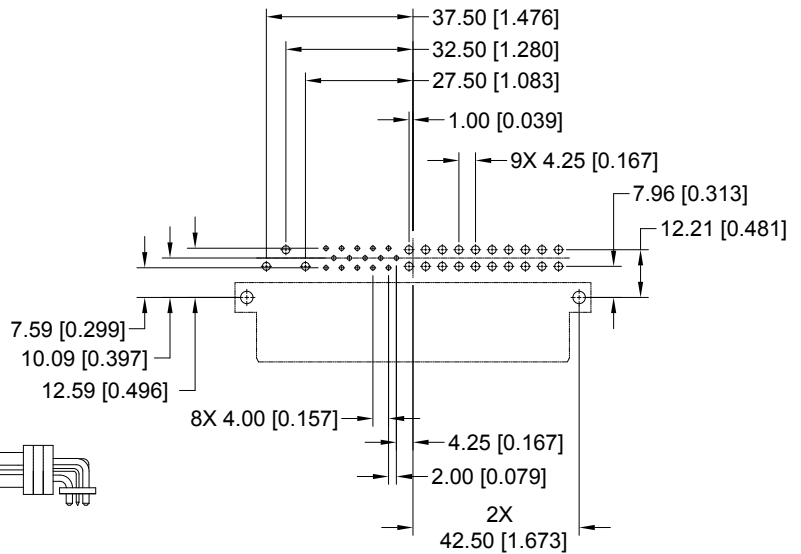

CONTACT HOLE PATTERN

Note: See below for suggested printed board hole sizes.

**FEMALE RIGHT ANGLE (90°) BOARD MOUNT CONNECTOR
CODE 4**

**PART NUMBER FOR INVERTED TERMINATION
PCIH38RF400A1**

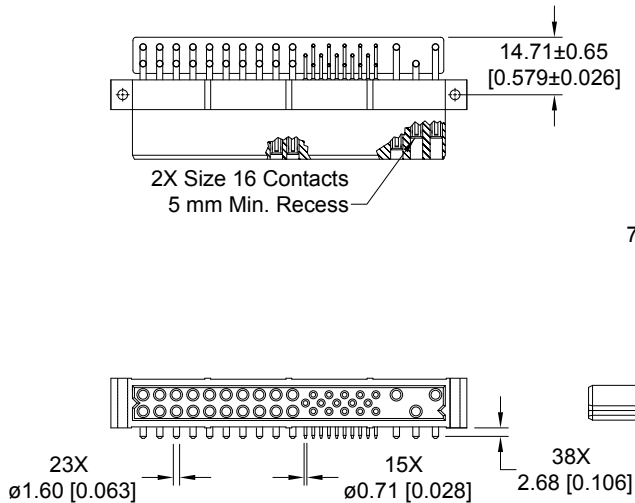

CONNECTOR DIMENSIONS

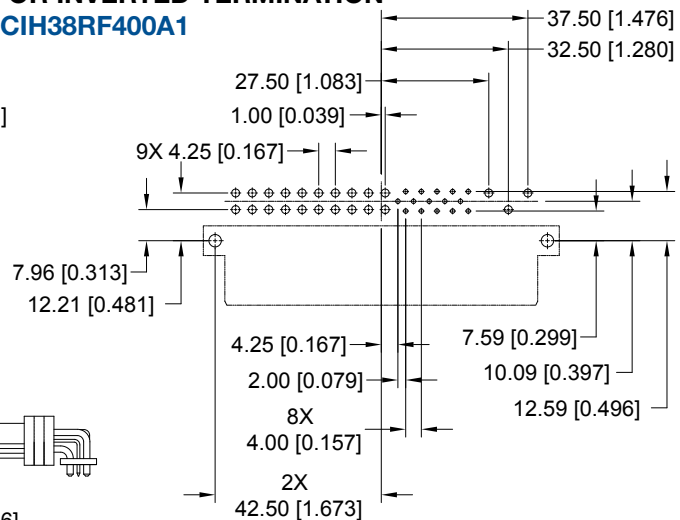

CONTACT HOLE PATTERN

SUGGESTED PRINTED BOARD HOLE SIZES:

- Suggest Ø1.14 [0.045] holes for size 20 contact holes.
- Suggest Ø2.03 [0.080] holes for size 16 contact holes.
- Suggest Ø3.56±0.08 [0.140±0.003] holes for connector mounting holes.



Positronic
connectpositronic.com

RIGHT ANGLE (90°) BOARD MOUNT CONNECTOR, FEMALE

Compact
Power
Connectors

FEMALE RIGHT ANGLE (90°) BOARD MOUNT CONNECTOR CODE 4

STANDARD PART NUMBER
PCIH47F400A1

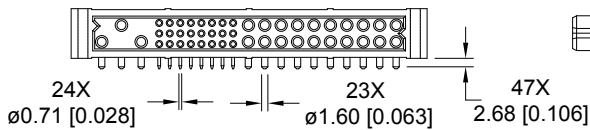
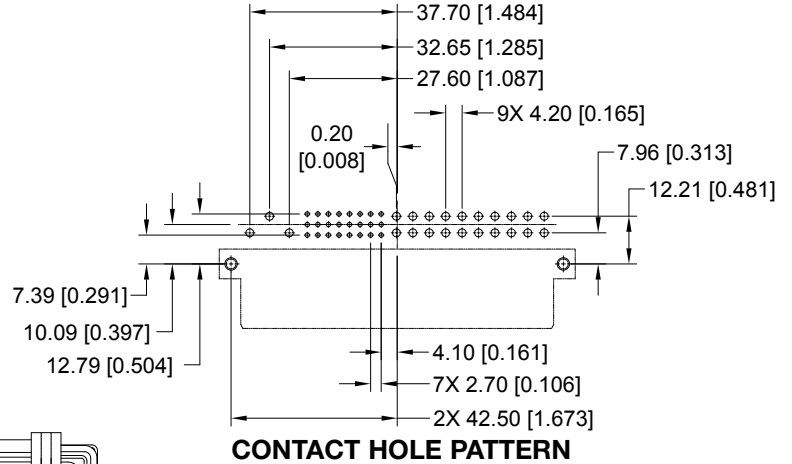
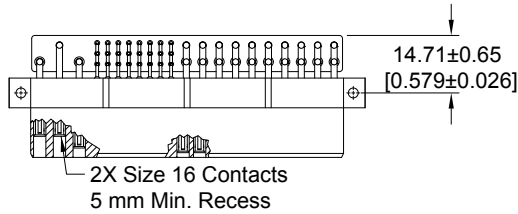

CONNECTOR DIMENSIONS

Note: See below for suggested printed board hole sizes.

FEMALE RIGHT ANGLE (90°) BOARD MOUNT CONNECTOR CODE 4

PART NUMBER FOR INVERTED TERMINATION
PCIH47RF400A1

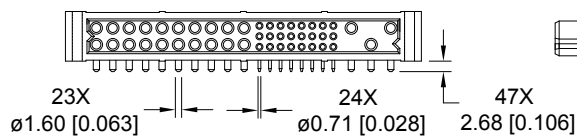
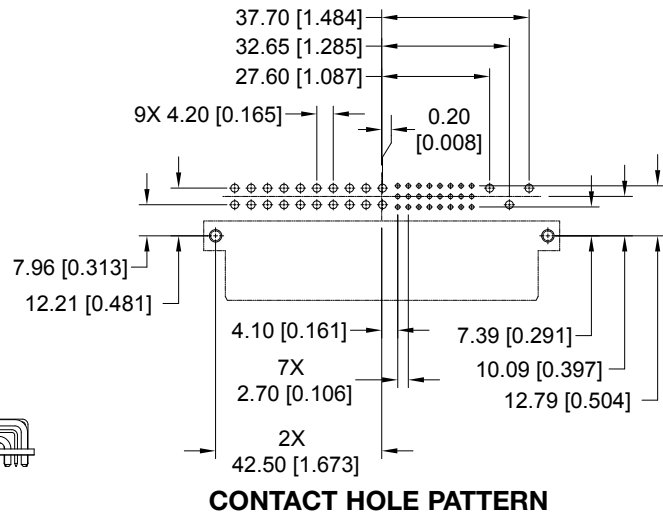
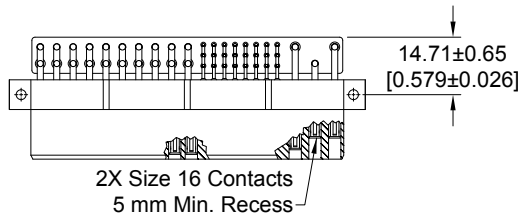

CONNECTOR DIMENSIONS

SUGGESTED PRINTED BOARD HOLE SIZES:

- Suggest Ø1.14 [0.045] holes for size 22 contact holes.
- Suggest Ø2.03 [0.080] holes for size 16 contact holes.
- Suggest Ø3.56±0.08 [0.140±0.003] holes for connector mounting holes.

**FEMALE RIGHT ANGLE (90°) BOARD MOUNT CONNECTOR WITH A.C. PASS-THROUGH
CODE 4 WITH MOS* -246.4**

CRIMP CONTACTS ARE NOT SUPPLIED WITH CONNECTOR AND MUST BE ORDERED SEPARATELY

**STANDARD PART NUMBER
PCIH47F400A1-246.4**

Crimp contacts ordered separately (see pages 102-103)

* For MOS descriptions, see chart on pages 107-108.

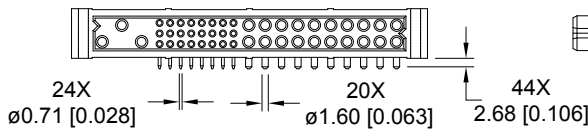
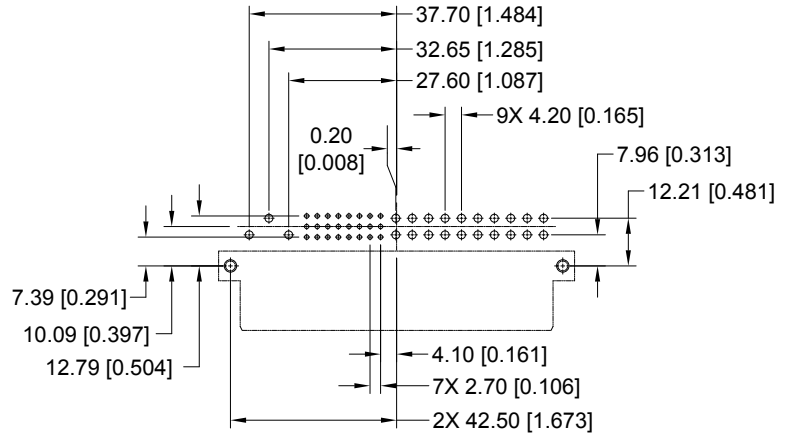
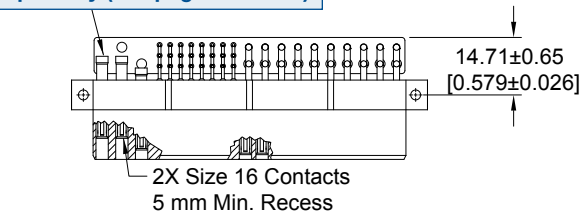

CONTACT HOLE PATTERN

Note: See below for suggested printed board hole sizes.

CONNECTOR DIMENSIONS

**FEMALE RIGHT ANGLE (90°) BOARD MOUNT CONNECTOR WITH A.C. PASS-THROUGH
CODE 4 WITH MOS* -246.4**

CRIMP CONTACTS ARE NOT SUPPLIED WITH CONNECTOR AND MUST BE ORDERED SEPARATELY

**PART NUMBER FOR INVERTED TERMINATION
PCIH47RF400A1-246.4**

Crimp contacts ordered separately (see pages 102-103)

* For MOS descriptions, see chart on pages 107-108.

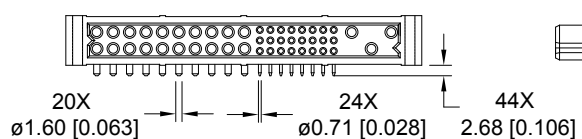
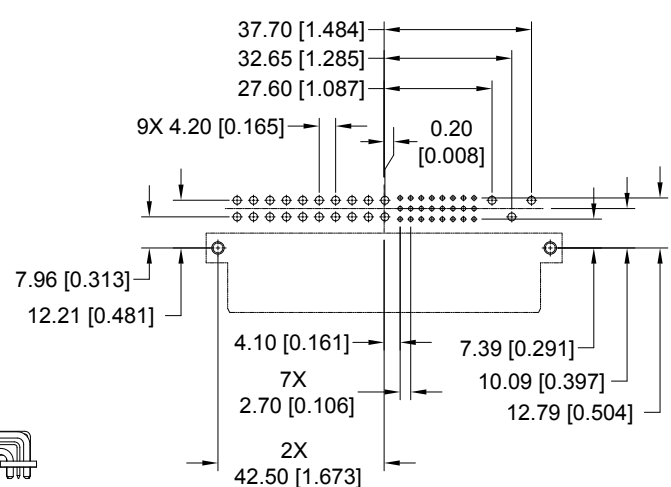
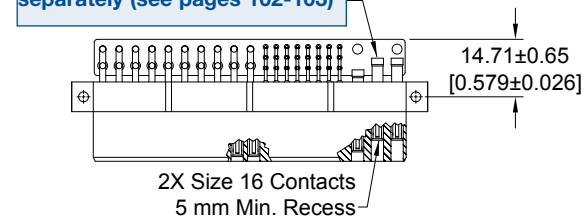

CONTACT HOLE PATTERN

CONNECTOR DIMENSIONS

SUGGESTED PRINTED BOARD HOLE SIZES:

- Suggest Ø1.14 [0.045] holes for size 22 contact holes.
- Suggest Ø2.03 [0.080] holes for size 16 contact holes.
- Suggest Ø3.56±0.08 [0.140±0.003] holes for connector mounting holes.



Positronic
connectpositronic.com

RIGHT ANGLE (90°) BOARD MOUNT CONNECTOR, FEMALE

Compact
Power
Connectors

FEMALE RIGHT ANGLE (90°) BOARD MOUNT CONNECTOR CODE 4 WITH MOS* -379.0

STANDARD PART NUMBER
PCIH49W25F400A1-379.0

* For MOS descriptions,
see chart on pages 107-108.

PCIH SERIES

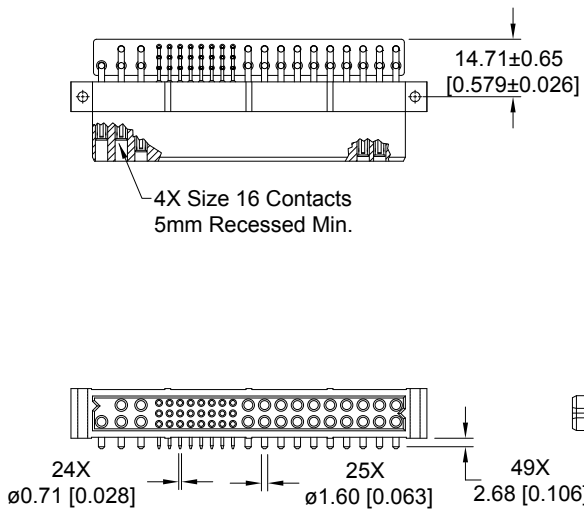

CONNECTOR DIMENSIONS

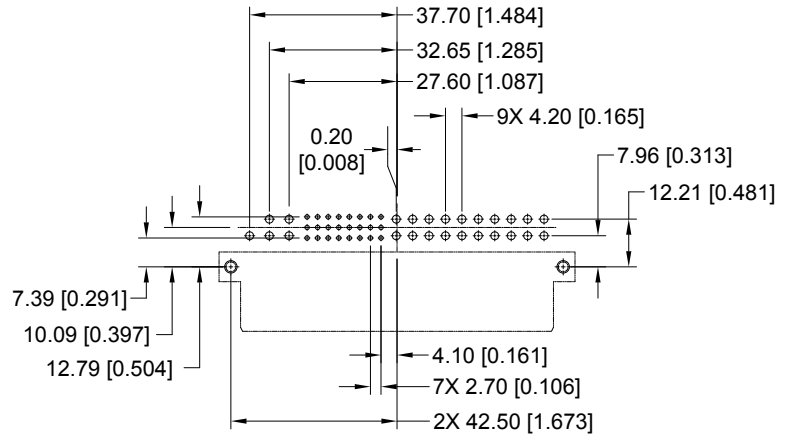

CONTACT HOLE PATTERN

Note: See below for suggested printed board hole sizes.

FEMALE RIGHT ANGLE (90°) BOARD MOUNT CONNECTOR CODE 4 WITH MOS* -379.0

PART NUMBER FOR INVERTED TERMINATION
PCIH49W25RF400A1-379.0

* For MOS descriptions,
see chart on pages 107-108.

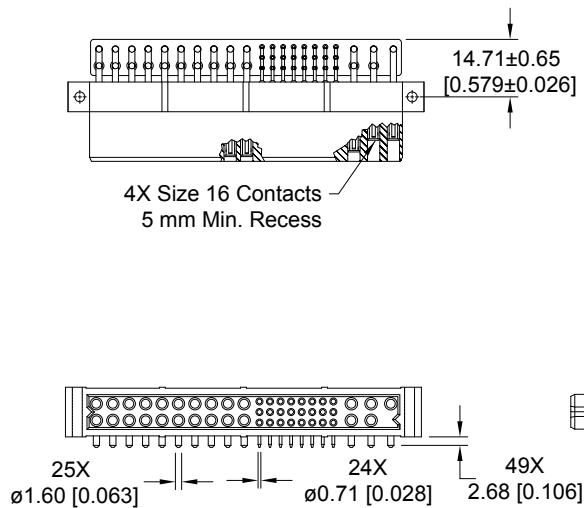

CONNECTOR DIMENSIONS

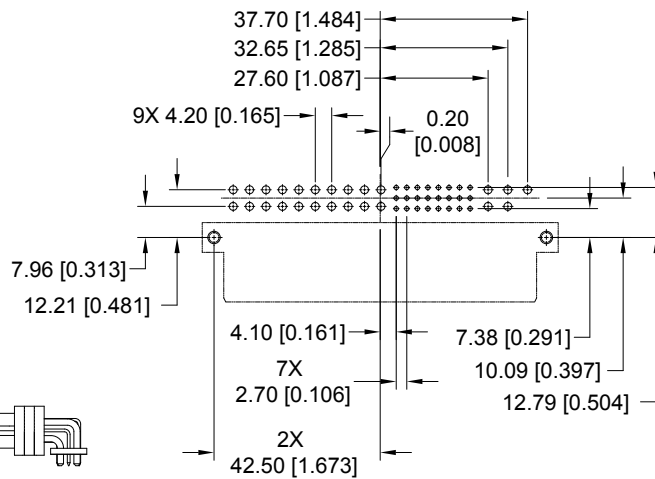

CONTACT HOLE PATTERN

SUGGESTED PRINTED BOARD HOLE SIZES:

Suggest Ø1.14 [0.045] holes for size 22 contact holes.

Suggest Ø2.03 [0.080] holes for size 16 contact holes.

Suggest Ø3.56±0.08 [0.140±0.003] holes for connector mounting holes.

**MALE RIGHT ANGLE (90°) BOARD MOUNT CONNECTOR
CODE 4**

**STANDARD PART NUMBER
PCIH38M400A1**

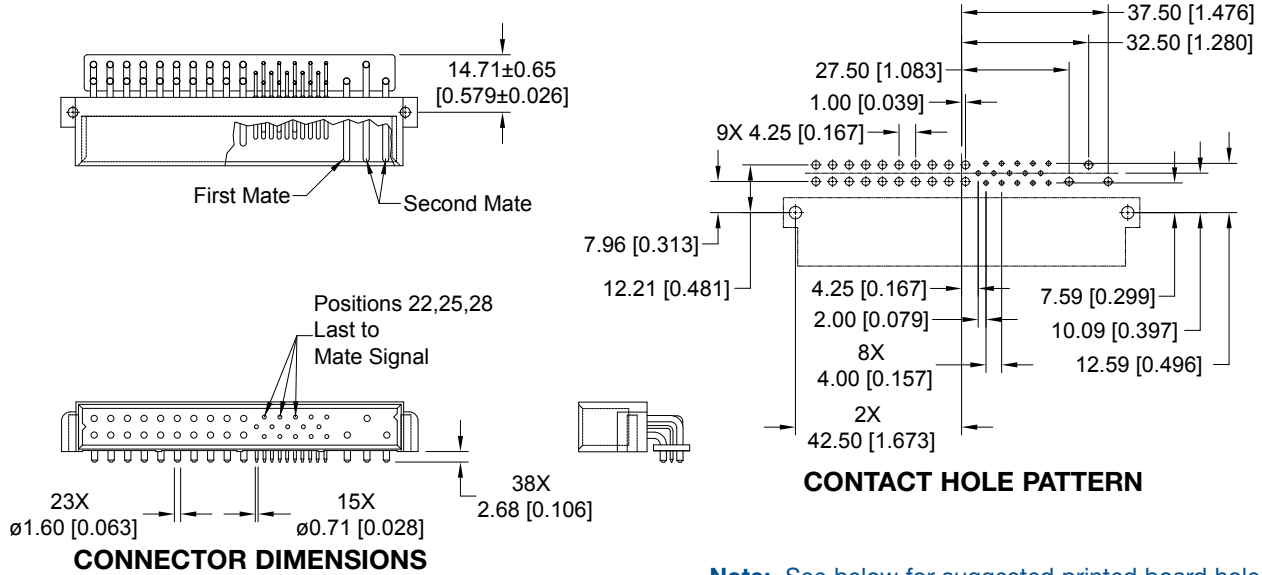

Note: See below for suggested printed board hole sizes.

**MALE RIGHT ANGLE (90°) BOARD MOUNT CONNECTOR
CODE 4**

**PART NUMBER FOR INVERTED TERMINATION
PCIH38RM400A1**

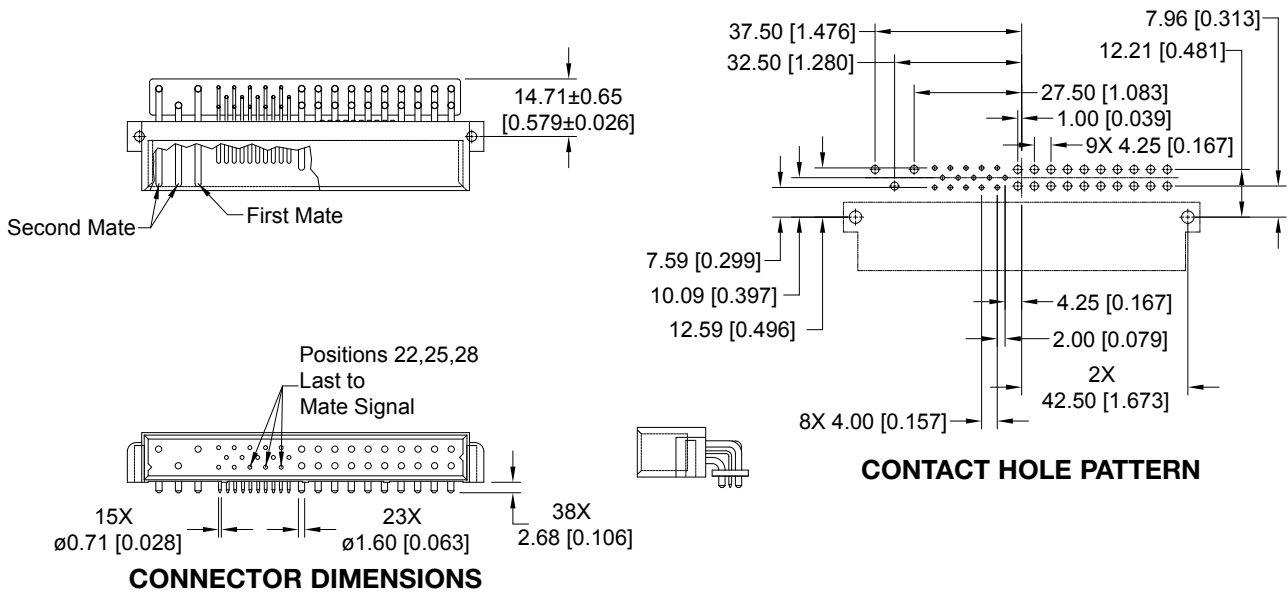

SUGGESTED PRINTED BOARD HOLE SIZES:

- Suggest Ø1.14 [0.045] holes for size 20 contact holes.
- Suggest Ø2.03 [0.080] holes for size 16 contact holes.
- Suggest Ø3.56±0.08 [0.140±0.003] holes for connector mounting holes.



RIGHT ANGLE (90°) BOARD MOUNT CONNECTOR, MALE

MALE RIGHT ANGLE (90°) BOARD MOUNT CONNECTOR CODE 4

STANDARD PART NUMBER
PCIH47M400A1

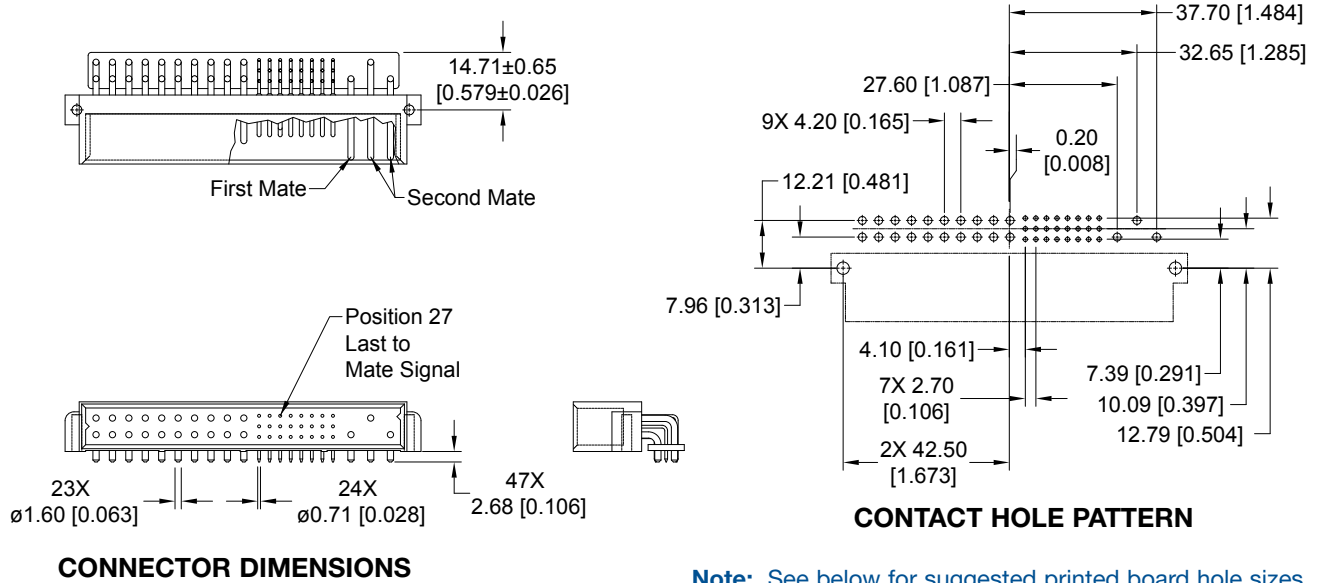

MALE RIGHT ANGLE (90°) BOARD MOUNT CONNECTOR CODE 4

PART NUMBER FOR INVERTED TERMINATION
PCIH47RM400A1

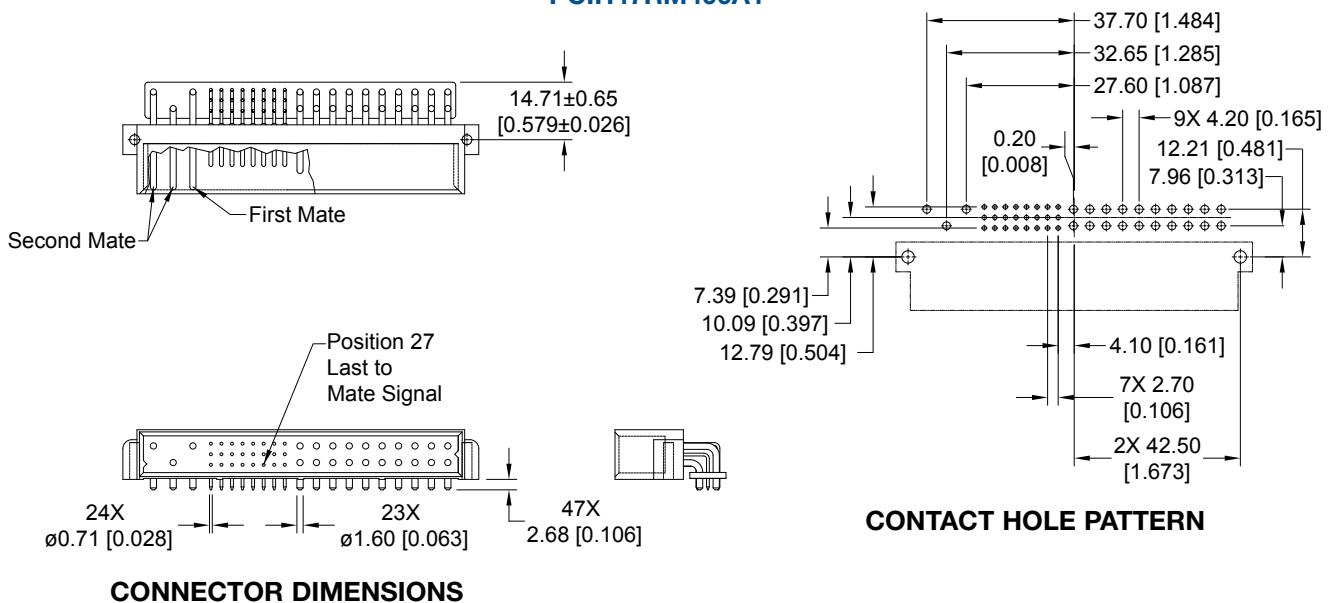

SUGGESTED PRINTED BOARD HOLE SIZES:

Suggest Ø1.14 [0.045] holes for size 22 contact holes.

Suggest Ø 2.03 [0.080] holes for size 16 contact holes.

Suggest Ø 3.56±0.08 [0.140±0.003] holes for connector mounting holes.

**MALE RIGHT ANGLE (90°) BOARD MOUNT CONNECTOR
CODE 4 WITH MOS* -378.0**

**STANDARD PART NUMBER
PCIH49W25M400A1-378.0**

** For MOS descriptions,
see chart on pages 107-108.*

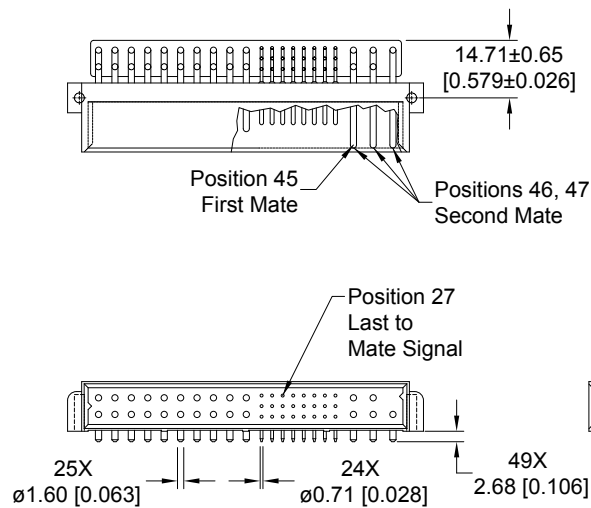

CONNECTOR DIMENSIONS

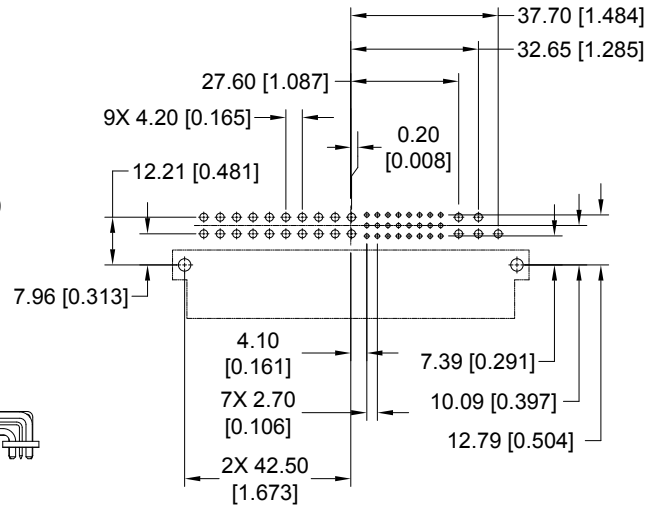

CONTACT HOLE PATTERN

SUGGESTED PRINTED BOARD HOLE SIZES:

- Suggest Ø1.14 [0.045] holes for size 20 contact holes.
- Suggest Ø2.03 [0.080] holes for size 16 contact holes.
- Suggest Ø3.56±0.08 [0.140±0.003] holes for connector mounting holes.

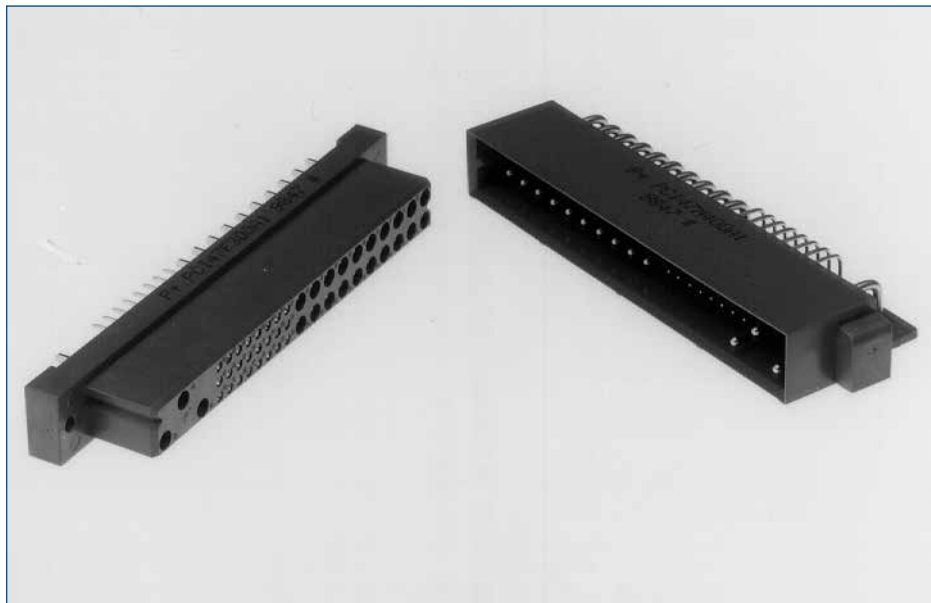



FEMALE PANEL MOUNT CRIMP CONTACT CONNECTORS CODE 8

CONTACTS ARE NOT SUPPLIED WITH CONNECTOR AND MUST BE ORDERED SEPARATELY

STANDARD PART NUMBER
PCIH38F8000

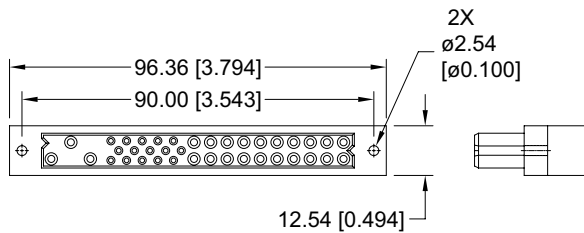
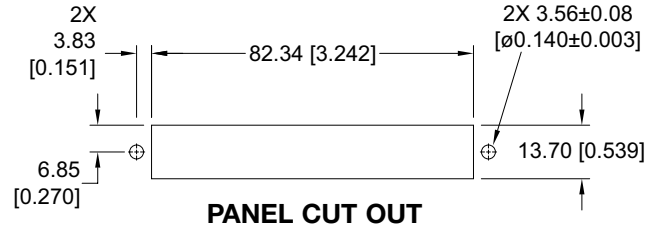
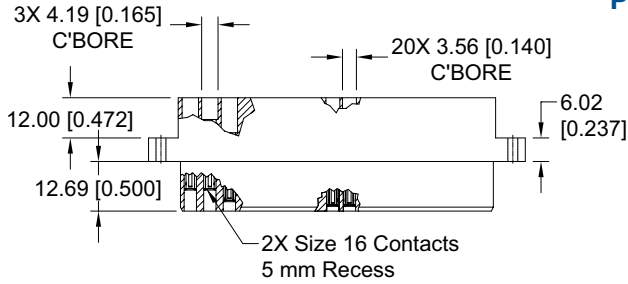

CONNECTOR DIMENSIONS

FEMALE PANEL MOUNT CRIMP CONTACT CONNECTORS CODE 8

CONTACTS ARE NOT SUPPLIED WITH CONNECTOR AND MUST BE ORDERED SEPARATELY

STANDARD PART NUMBER
PCIH47F8000, PCIH49W25F8000

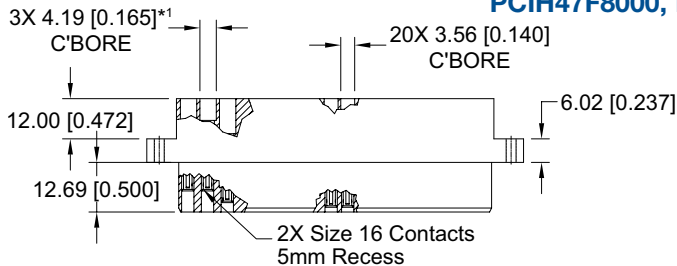

*1 For PCIH49W25 versions, this dimension is 3.56 [0.140].

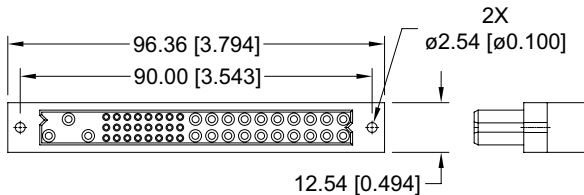
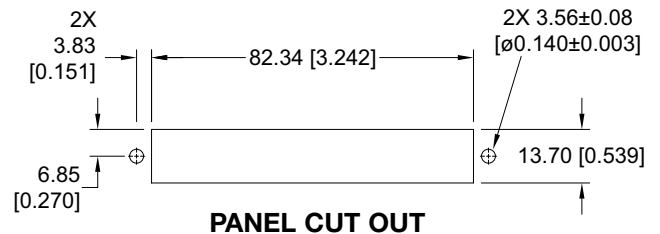

CONNECTOR DIMENSIONS

For information regarding removable contacts, see Removable Contact section, pages 102-103.



FEMALE COMPLIANT PRESS-FIT CONNECTOR CODE 93 OR 94

STANDARD PART NUMBER
PCIH38F9300A1, PCIH38F9400A1

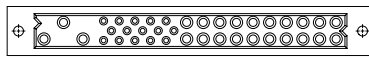
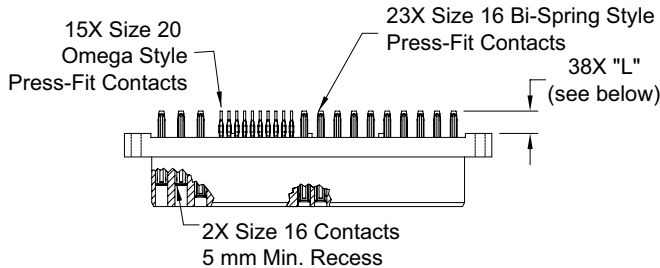

CONNECTOR DIMENSIONS

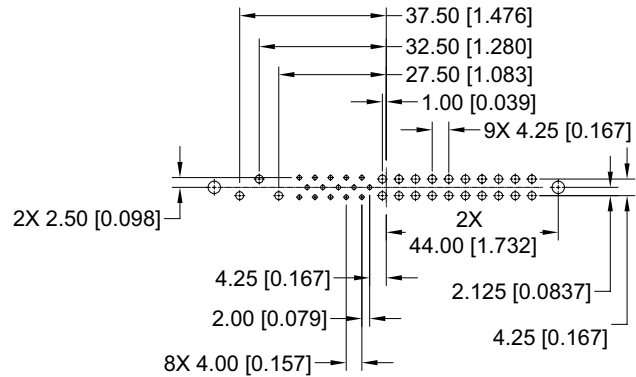

CONTACT HOLE PATTERN

CONTACT TAIL LENGTH		
Code	"L" Length	Board Thickness
93	5.72 [0.225]	2.29 to 4.45 [0.090 to 0.175]
94	7.04 [0.277]	4.45 min. [0.175 min.]

Note: See below for suggested printed board hole sizes, press-fit connector installation tools, and mounting screw options.

FEMALE COMPLIANT PRESS-FIT CONNECTOR WITH A.C. PASS-THROUGH CODE 93 OR 94 WITH MOS* -245.0

CRIMP CONTACTS ARE NOT SUPPLIED WITH CONNECTOR AND MUST BE ORDERED SEPARATELY

* For MOS descriptions, see chart on pages 107-108.

HIGH PROFILE PART NUMBER
PCIH38F9300A1-245.0
PCIH38F9400A1-245.0

Positronic recommends the practice of using mounting hardware to secure connector to printed circuit board.

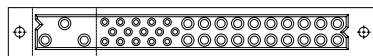
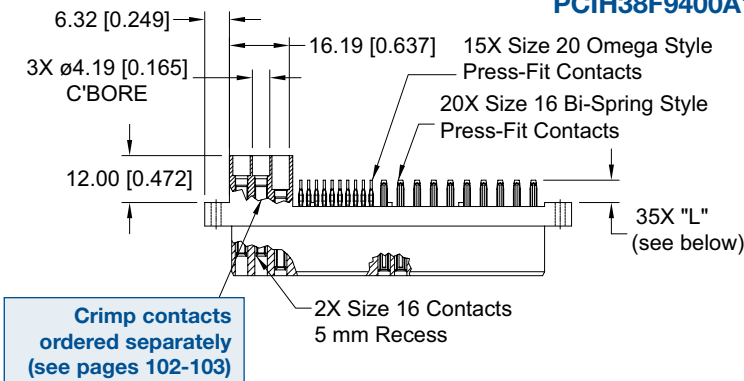

CONNECTOR DIMENSIONS

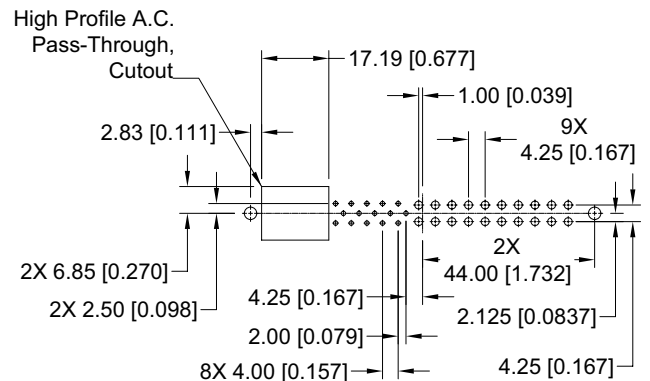

CONTACT HOLE PATTERN

CONTACT TAIL LENGTH		
Code	"L" Length	Board Thickness
93	5.72 [0.225]	2.29 to 4.45 [0.090 to 0.175]
94	7.04 [0.277]	4.45 min. [0.175 min.]

SUGGESTED PRINTED BOARD HOLE SIZES:

Suggest $\text{Ø}3.56 \pm 0.08$ [0.140 ± 0.003] holes for connector mounting holes.

NOTE: See page 105 for suggested printed board drill hole sizes, recommended plating and finished hole sizes for compliant contact termination positions.

For press-fit connector installation tools, see pages 105-106.

For mounting screw options, see page 105.

DIMENSIONS ARE IN MILLIMETERS [INCHES].
ALL DIMENSIONS ARE SUBJECT TO CHANGE. **30**



Positronic
connectpositronic.com

COMPLIANT PRESS-FIT BOARD MOUNT CONNECTOR, FEMALE

Compact
Power
Connectors

FEMALE COMPLIANT PRESS-FIT CONNECTOR WITH A.C. PASS-THROUGH CODE 93 OR 94 WITH MOS* -246.1

CRIMP CONTACTS ARE NOT SUPPLIED WITH CONNECTOR AND MUST BE ORDERED SEPARATELY

* For MOS descriptions,
see chart on pages 107-108.

LOW PROFILE PART NUMBER

PCIH38F9300A1-246.1
PCIH38F9400A1-246.1

Positronic recommends the practice of using mounting hardware to secure connector to printed circuit board.

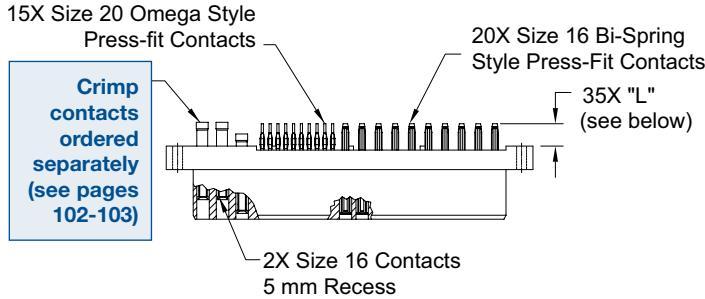

Crimp contacts ordered separately (see pages 102-103)

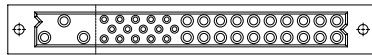

CONNECTOR DIMENSIONS

CONTACT TAIL LENGTH

Code	"L" Length	Board Thickness
93	5.72 [0.225]	2.29 to 4.45 [0.090 to 0.175]
94	7.04 [0.277]	4.45 min. [0.175 min.]

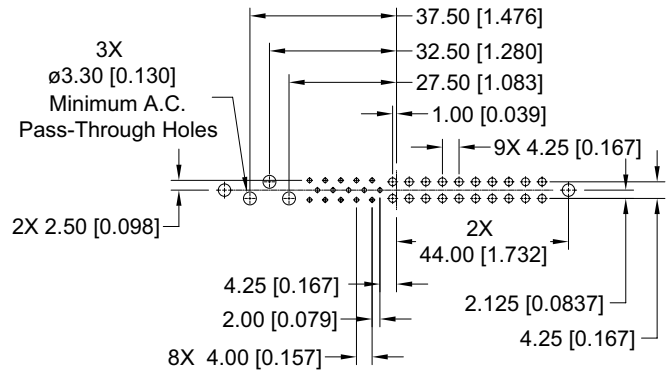

CONTACT HOLE PATTERN

Note: See below for suggested printed board hole sizes, press-fit connector installation tools, and mounting screw options.

FEMALE COMPLIANT PRESS-FIT CONNECTOR CODE 93 OR 94

STANDARD PART NUMBER

PCIH47F9300A1
PCIH47F9400A1

Positronic recommends the practice of using mounting hardware to secure connector to printed circuit board.

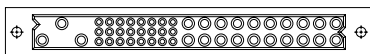
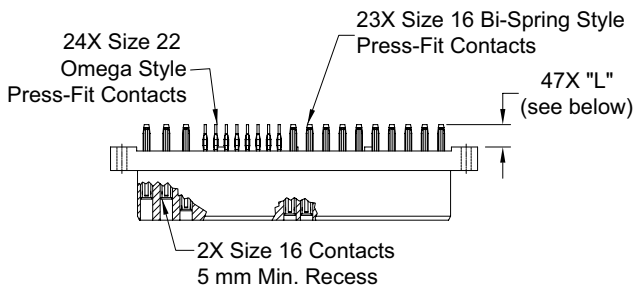

CONNECTOR DIMENSIONS

CONTACT TAIL LENGTH

Code	"L" Length	Board Thickness
93	5.72 [0.225]	2.29 to 4.45 [0.090 to 0.175]
94	7.04 [0.277]	4.45 min. [0.175 min.]

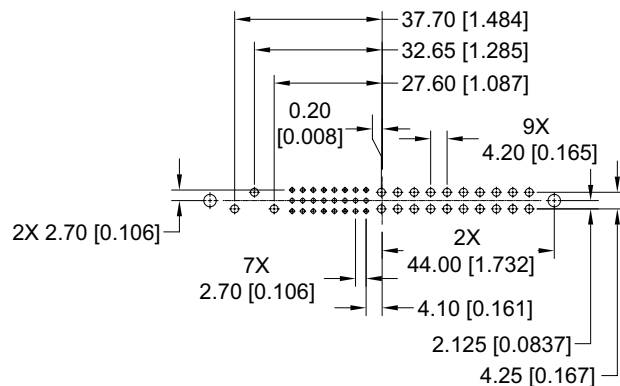

CONTACT HOLE PATTERN

SUGGESTED PRINTED BOARD HOLE SIZES:

Suggest $\varnothing 3.56 \pm 0.08$ [0.140 \pm 0.003] holes for connector mounting holes.

NOTE: See page 105 for suggested printed board drill hole sizes, recommended plating and finished hole sizes for compliant contact termination positions.

For press-fit connector installation tools, see pages 105-106.

For mounting screw options, see page 105.



FEMALE COMPLIANT PRESS-FIT CONNECTOR WITH A.C. PASS-THROUGH CODE 93 OR 94 WITH MOS* -246.0

CRIMP CONTACTS ARE NOT SUPPLIED WITH CONNECTOR AND MUST BE ORDERED SEPARATELY

* For MOS descriptions,
see chart on pages 107-108.

LOW PROFILE PART NUMBER

PCIH47F9300A1-246.0
PCIH47F9400A1-246.0

Positronic recommends the practice
of using mounting hardware to secure
connector to printed circuit board.

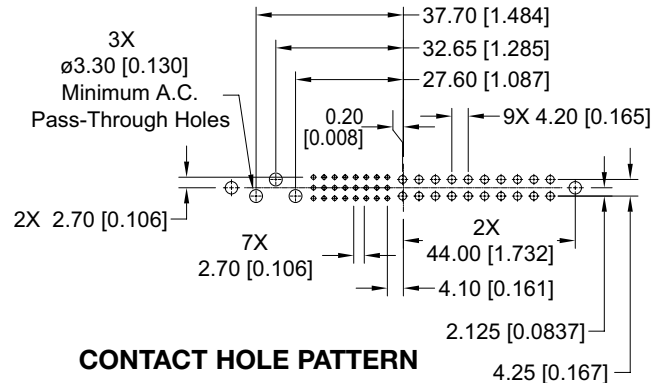
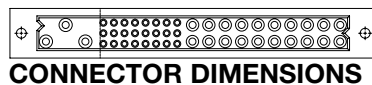
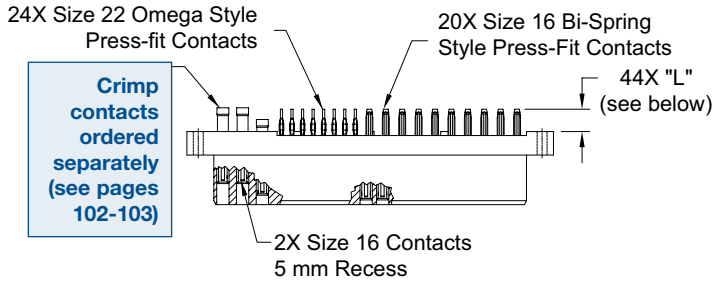

CONTACT TAIL LENGTH		
Code	"L" Length	Board Thickness
93	5.72 [0.225]	2.29 to 4.45 [0.090 to 0.175]
94	7.04 [0.277]	4.45 min. [0.175 min.]

Note: See below for suggested printed board hole sizes,
press-fit connector installation tools, and mounting
screw options.

FEMALE COMPLIANT PRESS-FIT CONNECTOR WITH A.C. PASS-THROUGH CODE 93 OR 94 WITH MOS* -246.3

CRIMP CONTACTS ARE NOT SUPPLIED WITH CONNECTOR AND MUST BE ORDERED SEPARATELY

* For MOS descriptions,
see chart on pages 107-108.

LOW PROFILE PART NUMBER

PCIH49W25F9300A1-246.3
PCIH49W25F9400A1-246.3

Positronic recommends the practice
of using mounting hardware to secure
connector to printed circuit board.

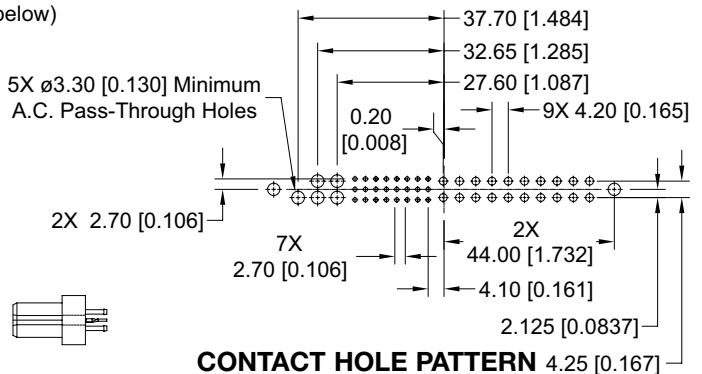
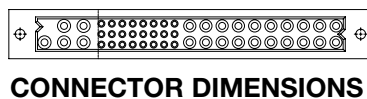
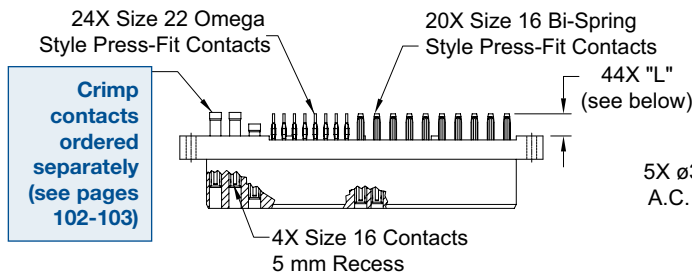

CONTACT TAIL LENGTH		
Code	"L" Length	Board Thickness
93	5.72 [0.225]	2.29 to 4.45 [0.090 to 0.175]
94	7.04 [0.277]	4.45 min. [0.175 min.]

SUGGESTED PRINTED BOARD HOLE SIZES:

Suggest $\text{Ø}3.56\pm 0.08$ [0.140±0.003] holes for connector mounting holes.

NOTE: See page 105 for suggested printed board drill hole sizes, recommended plating and finished hole sizes for compliant contact termination positions.

For press-fit connector installation tools, see pages 105-106.

For mounting screw options, see page 105.

**DIMENSIONS ARE IN MILLIMETERS [INCHES].
ALL DIMENSIONS ARE SUBJECT TO CHANGE.**



Positronic
connectpositronic.com

COMPLIANT PRESS-FIT BOARD MOUNT CONNECTOR, FEMALE

Compact
Power
Connectors

FEMALE COMPLIANT PRESS-FIT CONNECTOR CODE 93 OR 94 WITH MOS* -379.0

* For MOS descriptions,
see chart on pages 107-108.

STANDARD PART NUMBER
PCIH49W25F9300A1-379.0
PCIH49W25F9400A1-379.0

Positronic recommends the practice
of using mounting hardware to secure
connector to printed circuit board.

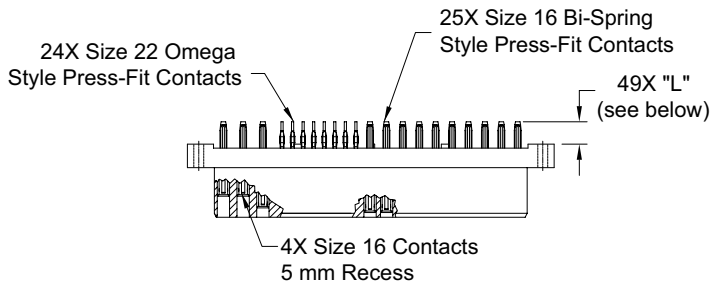

CONNECTOR DIMENSIONS

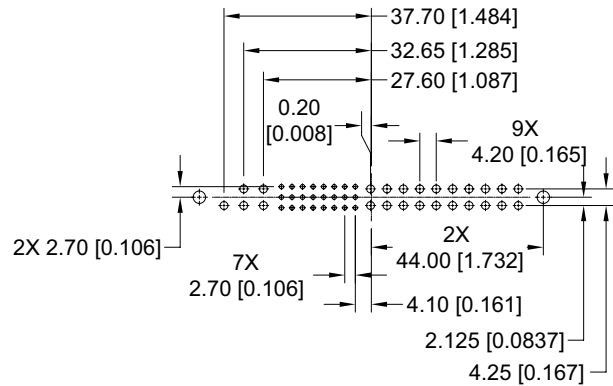

CONTACT HOLE PATTERN

CONTACT TAIL LENGTH

Code	"L" Length	Board Thickness
93	5.72 [0.225]	2.29 to 4.45 [0.090 to 0.175]
94	7.04 [0.277]	4.45 min. [0.175 min.]

SUGGESTED PRINTED BOARD HOLE SIZES:

Suggest $\varnothing 3.56 \pm 0.08$ [0.140 \pm 0.003] holes for connector mounting holes.

NOTE: See page 105 for suggested printed board drill hole sizes, recommended plating and finished hole sizes for compliant contact termination positions.

For press-fit connector installation tools, see pages 105-106.

For mounting screw options, see page 105.

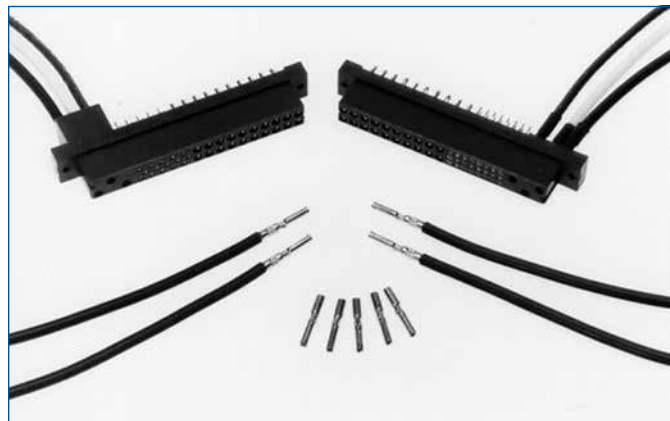



MALE COMPLIANT PRESS-FIT CONNECTOR CODE 93 OR 94

Positronic recommends the practice of using mounting hardware to secure connector to printed circuit board.

STANDARD PART NUMBER

PCIH38M9300A1
PCIH38M9400A1

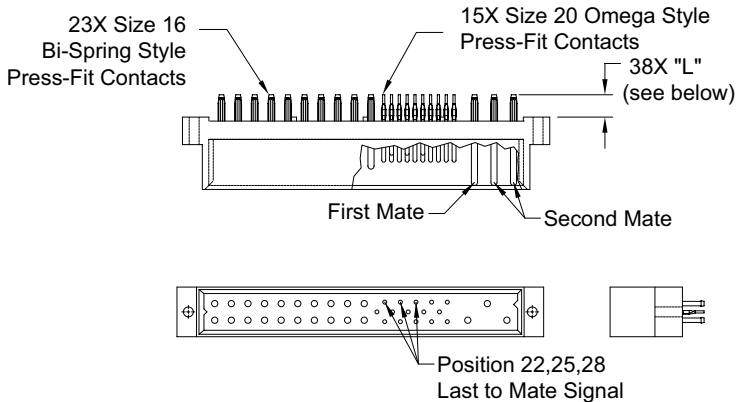

CONNECTOR DIMENSIONS

CONTACT TAIL LENGTH		
Code	"L" Length	Board Thickness
93	5.72 [0.225]	2.29 to 4.45 [0.090 to 0.175]
94	7.04 [0.277]	4.45 min. [0.175 min.]

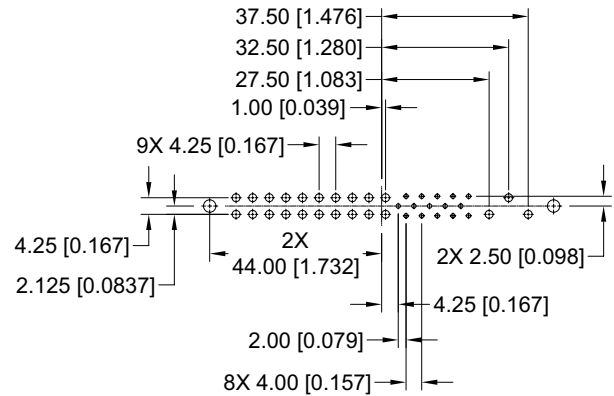

CONTACT HOLE PATTERN

Note: See below for suggested printed board hole sizes, press-fit connector installation tools, and mounting screw options.

MALE COMPLIANT PRESS-FIT CONNECTOR CODE 93 OR 94

Positronic recommends the practice of using mounting hardware to secure connector to printed circuit board.

STANDARD PART NUMBER

PCIH47M9300A1
PCIH47M9400A1

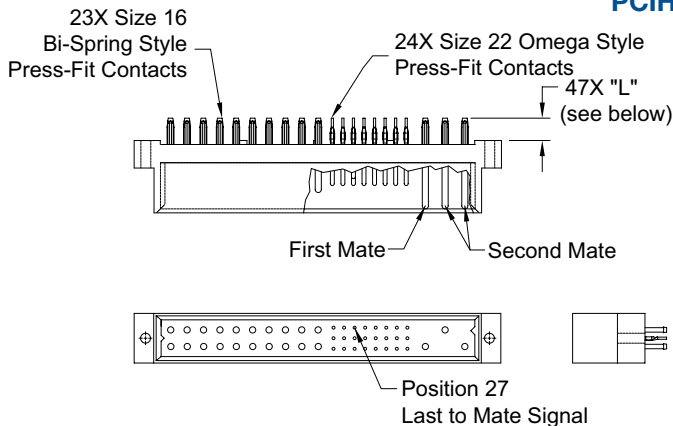

CONNECTOR DIMENSIONS

CONTACT TAIL LENGTH		
Code	"L" Length	Board Thickness
93	5.72 [0.225]	2.29 to 4.45 [0.090 to 0.175]
94	7.04 [0.277]	4.45 min. [0.175 min.]

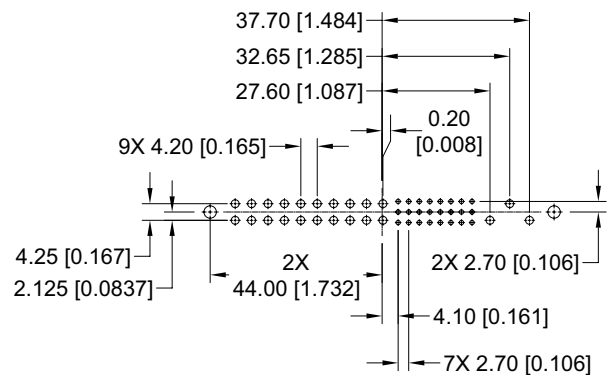

CONTACT HOLE PATTERN

SUGGESTED PRINTED BOARD HOLE SIZES:

Suggest $\varnothing 3.56 \pm 0.08$ [0.140 \pm 0.003] holes for connector mounting holes.

NOTE: See page 105 for suggested printed board drill hole sizes, recommended plating and finished hole sizes for compliant contact termination positions.

For press-fit connector installation tools, see pages 105-106.

For mounting screw options, see page 105.

**DIMENSIONS ARE IN MILLIMETERS [INCHES].
ALL DIMENSIONS ARE SUBJECT TO CHANGE.**



Positronic
connectpositronic.com

COMPLIANT PRESS-FIT BOARD MOUNT CONNECTOR, MALE

Compact
Power
Connectors

MALE COMPLIANT PRESS-FIT CONNECTOR CODE 93 OR 94 WITH MOS* -378.0

Positronic recommends the practice of using mounting hardware to secure connector to printed circuit board.

STANDARD PART NUMBER
PCIH49W25M9300A1-378.0
PCIH49W25M9400A1-378.0

* For MOS descriptions, see chart on pages 107-108.

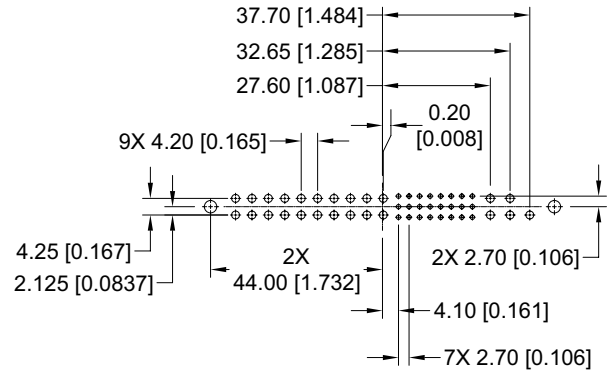
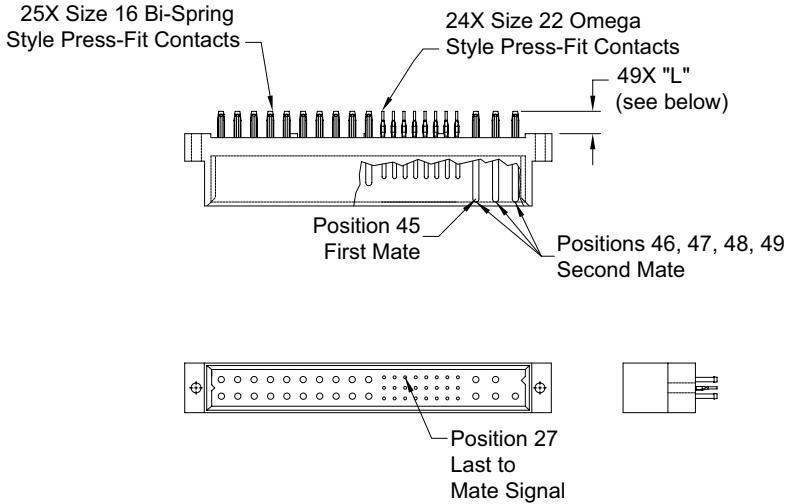

CONTACT HOLE PATTERN

CONNECTOR DIMENSIONS

CONTACT TAIL LENGTH		
Code	"L" Length	Board Thickness
93	5.72 [0.225]	2.29 to 4.45 [0.090 to 0.175]
94	7.04 [0.277]	4.45 min. [0.175 min.]

SUGGESTED PRINTED BOARD HOLE SIZES:

Suggest $\varnothing 3.56 \pm 0.08$ [0.140 \pm 0.003] holes for connector mounting holes.

NOTE: See page 105 for suggested printed board drill hole sizes, recommended plating and finished hole sizes for compliant contact termination positions.

For press-fit connector installation tools, see pages 105-106.

For mounting screw options, see page 105.

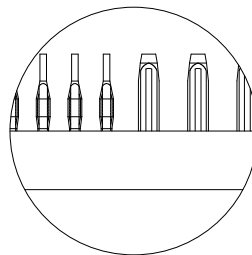

ENLARGED DETAIL OF COMPLIANT CONTACT TERMINATIONS

ORDERING INFORMATION - CODE NUMBERING SYSTEM

Specify Complete Connector By Selecting An Option From Step 1 Through 7

STEP	1	2	3	4	5	6	7	8	9
EXAMPLE	PCIH	47	F	93	0	0	A1	/AA	

STEP 1 - BASIC SERIES

PCIH - PCIH Series

STEP 2 - CONNECTOR VARIANTS

- 38 - 23 size 16 contacts and 15 size 20 contacts
- 38R - 23 size 16 contacts and 15 size 20 contacts inverted termination style, use with contact type "4"
- 47 - 23 size 16 contacts and 24 size 22 contacts
- 47R - 23 size 16 contacts and 24 size 22 contacts inverted termination style, use with contact type "4"
- 49W25 - 25 size 16 contacts and 24 size 22 contacts
- *149W25R - 25 size 16 contacts and 24 size 22 contacts inverted termination style, use with contact type "4"

STEP 3 - CONNECTOR GENDER

- F - Female
- M - Male

STEP 4 - CONTACT TERMINATION TYPE

- 3 - Solder, Straight Printed Board Mount with 4.50 [0.177] tail extension for connection systems 1 and 2.
- 4 - Solder, Right Angle (90°) Printed Board Mount with 2.68 [0.106] tail extension for connection systems 1, 2, 3 and 4.
- 8 - Contacts must be ordered separately for Panel Mount Cable Connectors, connection system 3, see pages 102-103. Female connector only.
- 93 - Press-Fit, Compliant Termination size 16 and size 20 or size 22 Straight Printed Board Mount for use with board thicknesses of 2.29 to 4.45 [0.090 to 0.175]. Connection systems 1 and 2.
- 94 - Press-Fit, Compliant Termination size 16 and size 20 or size 22 Straight Printed Board Mount for use with board thickness of 4.45 minimum [0.175 minimum]. Connection systems 1 and 2.

STEP 5 - MOUNTING STYLE

- 0 - Not Applicable
- See page 105 for mounting screw options.

STEP 6 - HOODS

- 0 - Not applicable

STEP 9 - SPECIAL OPTIONS

FOR LISTING OF SPECIAL OPTIONS, SEE SPECIAL OPTIONS APPENDIX ON PAGES 107-108.

STEP 8 - ENVIRONMENTAL COMPLIANCE OPTIONS

/AA - RoHS Compliant

NOTE: If compliance to environmental legislation is not required, this step will not be used.
Example: PCIH47F9300A1

STEP 7 - CONTACT PLATING FOR PRINTED BOARD TYPE CONNECTORS

- 0 - Crimp contacts ordered separately
- A1 - Gold flash over nickel on mating end and termination end.
- A2 - Gold flash over nickel on mating end and 5.00µ [0.00020 inch] tin-lead solder coat on termination end. Not available with code 93 or code 94 in step 4.
- C1 - 0.76µ [0.000030 inch] gold over nickel on mating end and termination end.
- C2 - 0.76µ [0.000030 inch] gold over nickel on mating end and 5.00µ [0.00020 inch] tin-lead solder coat on termination end. Not available with code 93 or code 94 in step 4.
- D1 - 1.27µ [0.000050 inch] gold over nickel on mating end and termination end.
- D2 - 1.27µ [0.000050 inch] gold over nickel on mating end and 5.00µ [0.00020 inch] tin-lead solder coat on termination end. Not available with code 93 or code 94 in step 4.

NOTE: If you would like a 2D drawing or 3D model, once you've made your connector selection, please visit www.connectpositronic.com. If you can't find your specific part number on our web site, contact Technical Sales to have one created.

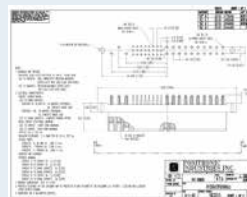

2D Drawing

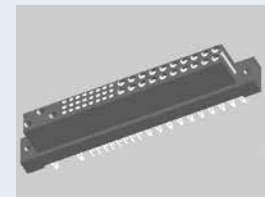

3D model

*1 Female contact variants are readily available. Contact Technical Sales for availability of male contact variants.



The PCIA Series encompasses all of the features of the PCIH Series and provides greater input and output current capacity in a slightly larger package. The package size is suitable for 6U and larger based systems or in systems which do not conform to a particular standard. Reliability, high current capacity and many system management connections make the PCIA Series ideal for higher wattage power supplies which are used in telecom, computer, information systems and industrial applications.

PCIA SERIES CONTACT VARIANTS

FACE VIEW OF MALE AND REAR VIEW OF FEMALE

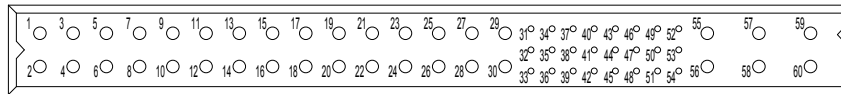

PCIA60W36 VARIANT

36 Size 16 Power Contacts and 24 Size 22 Signal Contacts

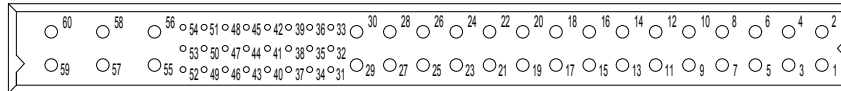

PCIA60W36R VARIANT (Inverted Termination)

36 Size 16 Power Contacts and 24 Size 22 Signal Contacts
Currently available in female only, use with contact type 4.

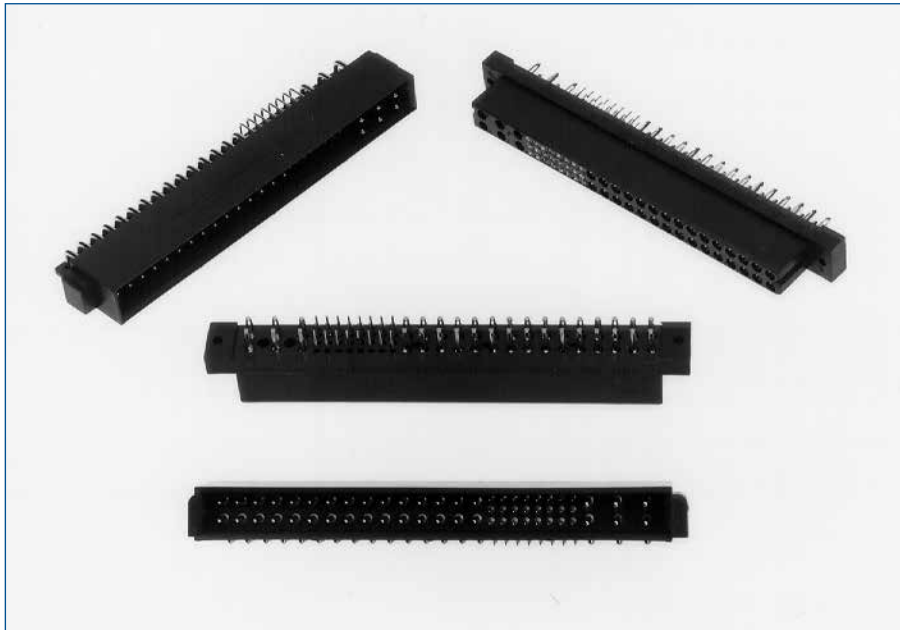



MATERIALS AND FINISHES:

Insulator:	Glass-filled polyester, UL 94V-0, blue color.
Contacts:	Size 16 contacts: High conductivity precision-machined copper alloy. Size 22 contacts: Precision-machined copper alloy.
Plating:	Gold flash over nickel. Other plating options available, refer to Step 7 on page 45.
Mounting Screws:	Steel, zinc plated.

MECHANICAL CHARACTERISTICS:

Blind Mating System:	Male and female connector bodies provide "lead-in" for 1.3mm [0.050 inch] diametral misalignment.
Polarization:	Provided by connector body design.
Removable Contacts:	Install contact from rear of insulator; release from front of insulator. Size 16 and 22 female contacts feature "Closed Entry" design for highest reliability.

Removable Contact Retention in Connector Body:

Size 16 Contacts:	67 N [15 lbs.]
Size 22 Contacts:	27 N [6 lbs.]

Fixed Contacts:	Printed board terminations, both straight and right angle (90°). Size 16 female contacts feature "Closed Entry" design. Size 22 feature rugged "Open Entry" contact design. "Closed Entry" contacts available, consult Technical Sales.
------------------------	---

Fixed Contact Retention in Connector Body:

Size 16 Contacts:	45 N [10 lbs.]
Size 22 Contacts:	27 N [6 lbs.]

Resistance to Solder Heat:	260°C [500°F] for 10 seconds duration per IEC 512-6, Test 12e, 25-watt soldering iron.
-----------------------------------	--

Sequential Contact Mating System:

PCIA60W36:	First mate contacts 55 and 56 and last mate contact position 37.
-------------------	--

Consult Technical Sales for customer specified sequential mating.

Safety "Recessed in Insulator" Contacts:

The following size 16 contacts are recessed 5mm [0.197 inch] below the face of the female connector insulator per safety requirements.

PCIA60W36:	Contact positions 57 through 60.
-------------------	----------------------------------

Compliant Terminations:	Size 16 and 22 contacts are available with Compliant Contact Terminations. Average insertion and extraction forces of size 16 contacts are 22N (5 lbs.) per contact.
--------------------------------	--

Printed Board Mounting:	Mounting holes provided in connector body for printed board mounting. Self-tapping screws are available.
Mechanical Operations:	250 couplings, minimum.

ELECTRICAL CHARACTERISTICS:

PCIA Contact Current Ratings, per UL 1977

See *Temperature Rise Curves* on page 4 for details.

Size 16 Power Contacts:

Positions 55 through 60:	38 amperes continuous, all contacts under load.
Positions 1 through 30:	28 amperes continuous, all contacts under load.

Size 22 Signal Contacts:

3 amperes nominal rating.

Initial Contact Resistance:

Size 16 Contact:	0.0007 ohms maximum.
Size 22 Contact:	0.004 ohms maximum. Per IEC 512-2, Test 2b.

Insulator Resistance:

5 G ohms per IEC 512-2, Test 3a.

Voltage Proof:

PCIA60W36:

Contacts 55 through 60:	3,000 V r.m.s.
Contacts 1 through 30:	1,500 V r.m.s.
Contacts 31 through 54:	1,000 V r.m.s.

Creepage and Clearance

Distance; minimum:

PCIA60W36:

Contacts 59 and 60 to Contacts 55 and 56:	3.2mm [0.126 inch]
Contacts 57 and 58 to Contacts 55 and 56:	3.2mm [0.126 inch]
Contacts 59 and 60 to Signal Contacts:	6.4mm [0.252 inch]
Contacts 57 and 58 to Signal Contacts:	6.4mm [0.252 inch]
Contacts 59 and 60 to Contacts 57 and 58:	2.5mm [0.098 inch]
Contacts 55 and 56 to Signal Contacts:	2.0mm [0.079 inch]

Working Voltage:

PCIA60W36:

Contacts 55 through 60:	1,000 V r.m.s.
Contacts 1 through 30:	500 V r.m.s.
Contacts 31 through 54:	333 V r.m.s.

CLIMATIC CHARACTERISTICS:

Working Temperature:	-55°C to +125°C.
-----------------------------	------------------

**U.L. Recognized File #E49351
CSA Recognized File #LR54219**



CONNECTOR OUTLINE AND MATING DIMENSIONS

PCIA CONNECTOR OUTLINE DIMENSIONS

RIGHT ANGLE (90°) BOARD MOUNT CONNECTOR

MALE CONNECTOR

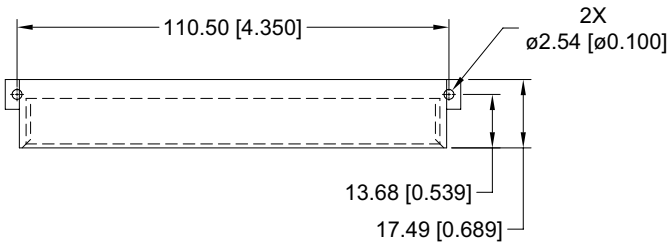

FEMALE CONNECTOR

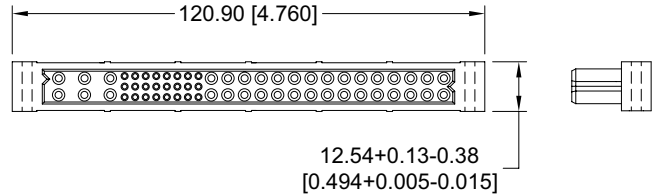
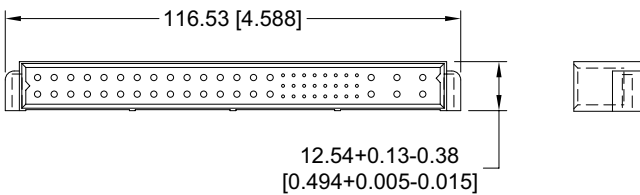
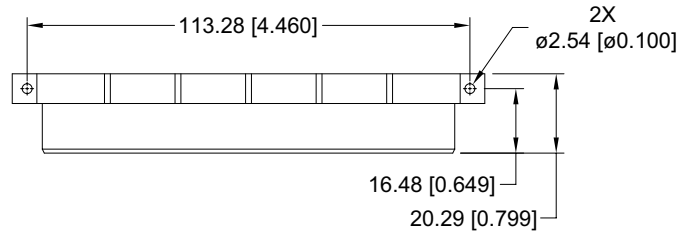

STRAIGHT BOARD MOUNT CONNECTOR

MALE CONNECTOR

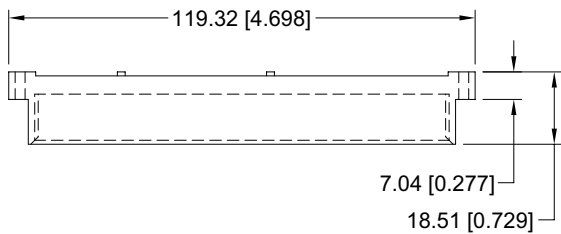

FEMALE CONNECTOR

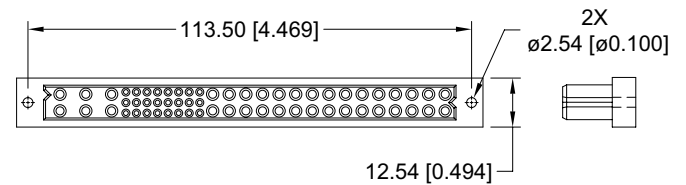
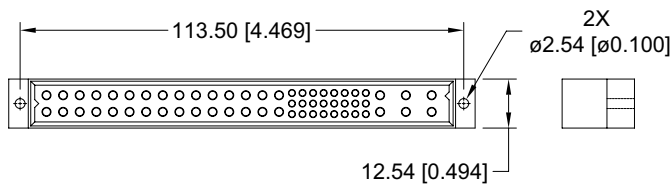
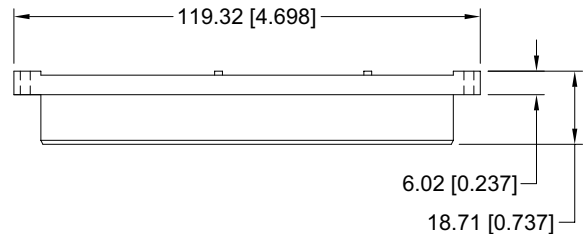

PCIA CONNECTOR MATING DIMENSIONS (FULLY MATED)

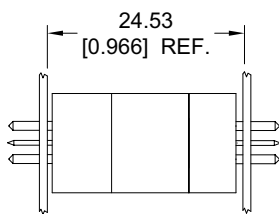

Straight Board
Mount Male to Straight
Board Mount or Panel
Mount Female

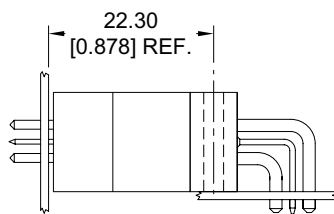

Straight Board
Mount Male to
Right Angle (90°)
Board Mount Female

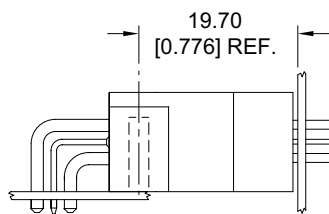

Right Angle (90°) Board
Mount Male to Straight
Board Mount or Panel
Mount Female

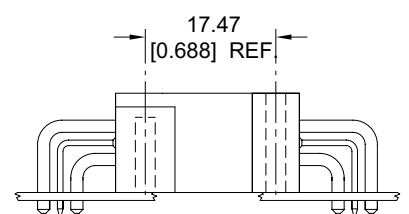

Right Angle (90°)
Board Mount Male to
Right Angle (90°)
Board Mount Female

FEMALE STRAIGHT SOLDER CONNECTOR CODE 3

STANDARD PART NUMBER
PCIA60W36F300A1

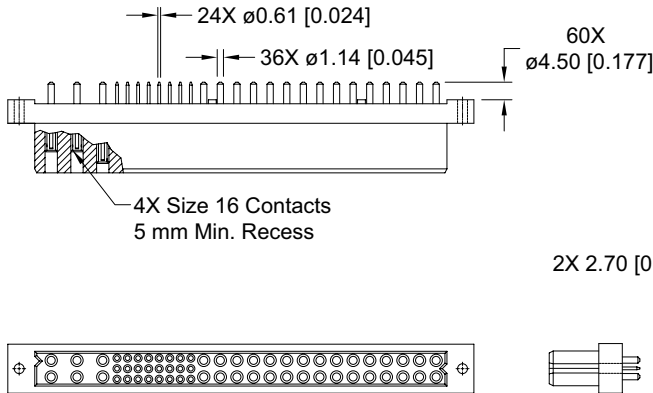

CONNECTOR DIMENSIONS

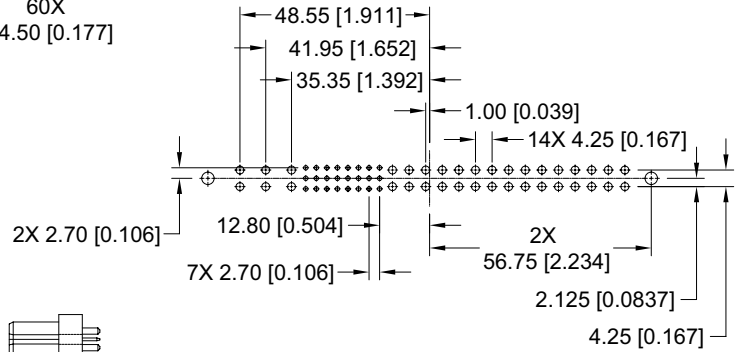

CONTACT HOLE PATTERN

Note: See below for suggested printed board hole sizes.

MALE STRAIGHT SOLDER CONNECTOR CODE 3

STANDARD PART NUMBER
PCIA60W36M300A1

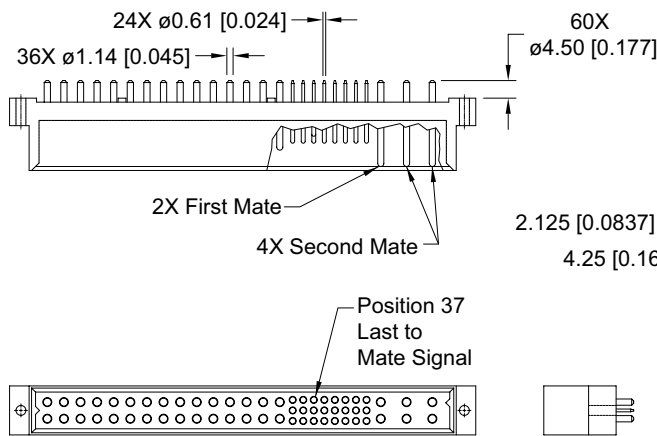

CONNECTOR DIMENSIONS

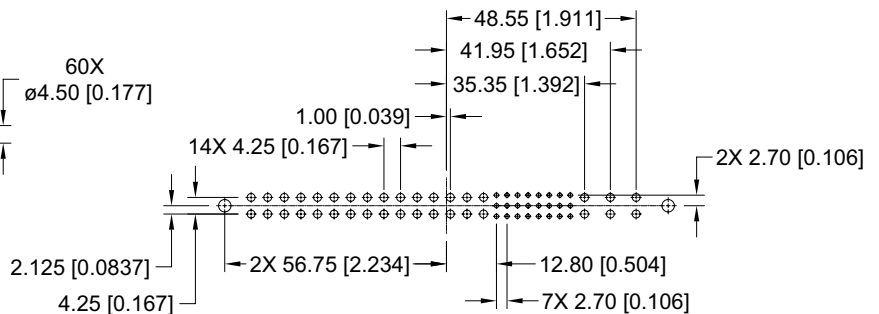

CONTACT HOLE PATTERN

SUGGESTED PRINTED BOARD HOLE SIZES:

- Suggest Ø1.00 [0.039] holes for size 22 contact holes.
- Suggest Ø1.60 [0.063] holes for size 16 contact holes.
- Suggest Ø3.56±0.08 [0.140±0.003] holes for connector mounting holes.



Positronic
connectpositronic.com

RIGHT ANGLE (90°) BOARD MOUNT CONNECTOR, FEMALE

Compact
Power
Connectors

FEMALE RIGHT ANGLE (90°) BOARD MOUNT CONNECTOR CODE 4

STANDARD PART NUMBER
PCIA60W36F400A1

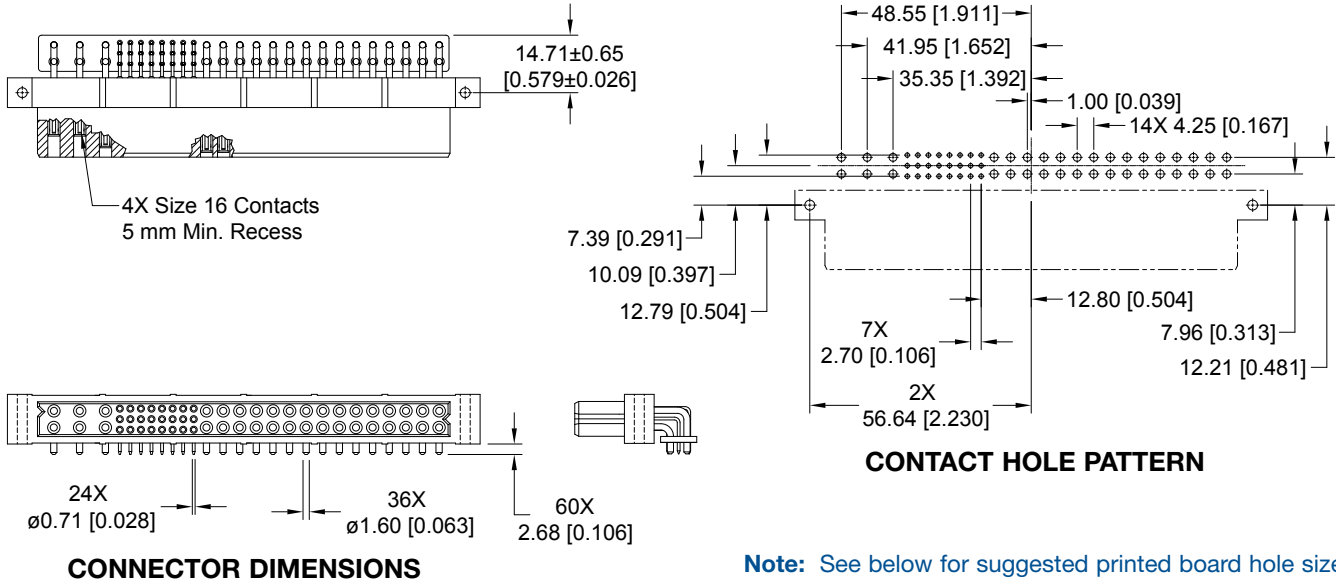

FEMALE RIGHT ANGLE (90°) BOARD MOUNT CONNECTOR CODE 4

PART NUMBER FOR INVERTED TERMINATION
PCIA60W36RF400A1

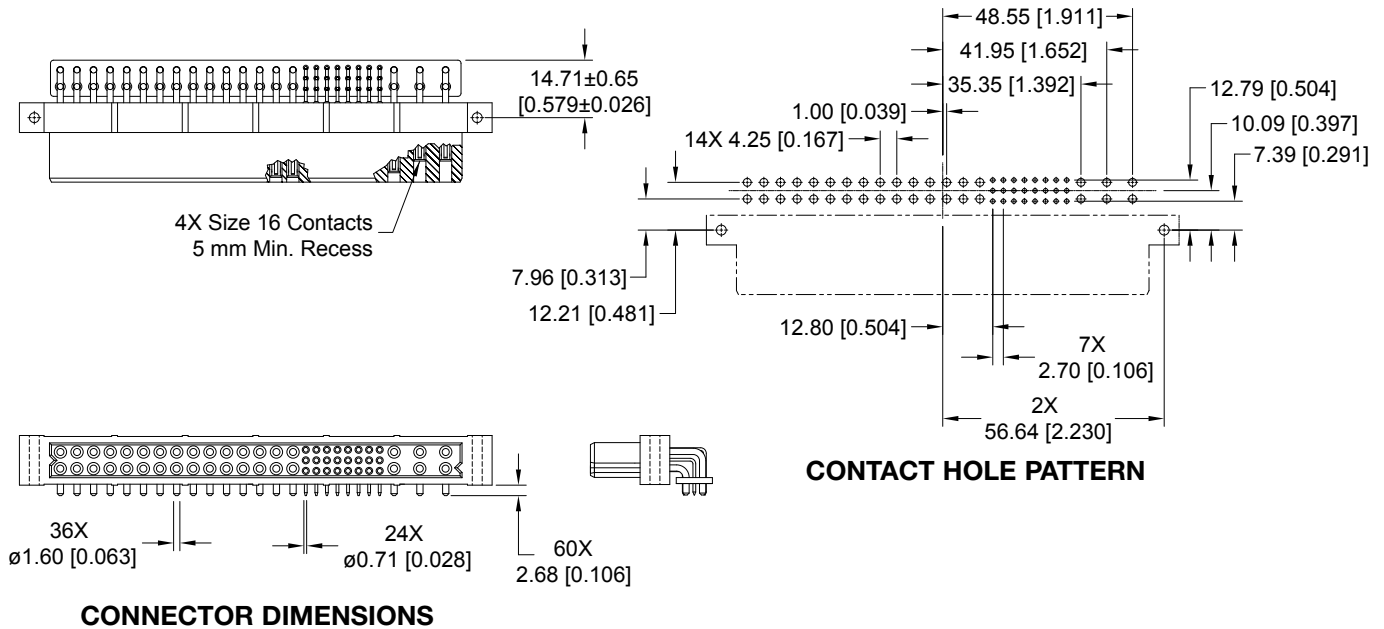

SUGGESTED PRINTED BOARD HOLE SIZES:

Suggest $\varnothing 1.14$ [0.045] holes for size 22 contact holes.

Suggest $\varnothing 2.03$ [0.080] holes for size 16 contact holes.

Suggest $\varnothing 3.56 \pm 0.08$ [0.140 ± 0.003] holes for connector mounting holes.

**MALE RIGHT ANGLE (90°) BOARD MOUNT CONNECTOR
CODE 4**

**STANDARD PART NUMBER
PCIA60W36M400A1**

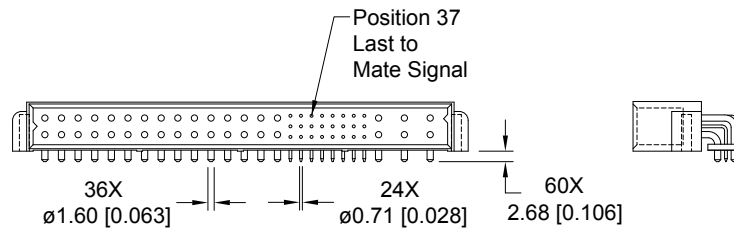
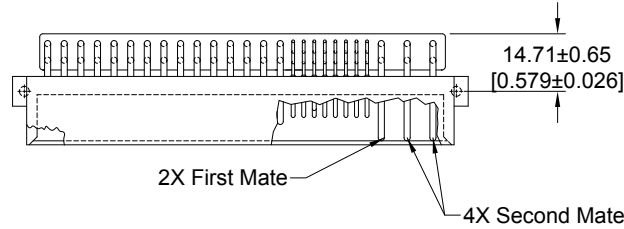

CONNECTOR DIMENSIONS

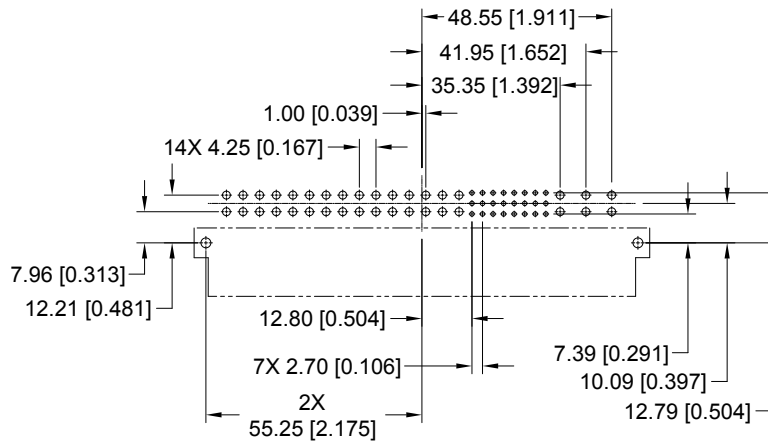

CONTACT HOLE PATTERN

SUGGESTED PRINTED BOARD HOLE SIZES:

Suggest Ø1.14 [0.045] holes for size 22 contact holes.

Suggest Ø2.03 [0.080] holes for size 16 contact holes.

Suggest Ø3.56±0.08 [0.140±0.003] holes for connector mounting holes.

**DIMENSIONS ARE IN MILLIMETERS [INCHES].
ALL DIMENSIONS ARE SUBJECT TO CHANGE.**



PANEL MOUNT CONNECTOR, FEMALE

FEMALE PANEL MOUNT CRIMP CONTACT CONNECTOR CODE 8

CONTACTS ARE NOT SUPPLIED WITH CONNECTOR AND MUST BE ORDERED SEPARATELY

STANDARD PART NUMBER
PCIA60W36F8000

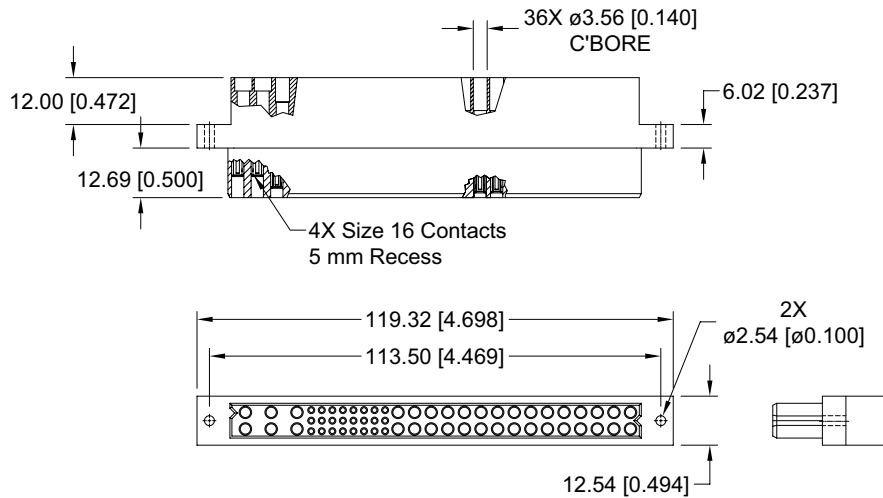

CONNECTOR DIMENSIONS

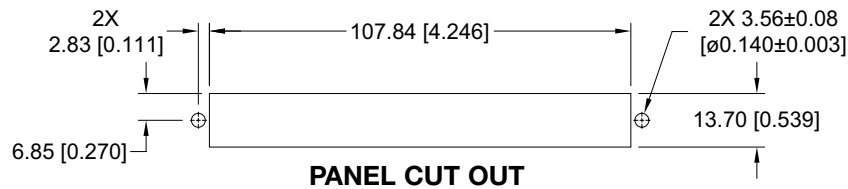

PANEL CUT OUT

For information regarding removable contacts, see Removable Contact section, pages 102-103.



FEMALE COMPLIANT PRESS-FIT CONNECTOR CODE 93 OR 94

STANDARD PART NUMBER

PCIA60W36F9300A1

PCIA60W36F9400A1

Positronic recommends the practice of using mounting hardware to secure connector to printed circuit board.

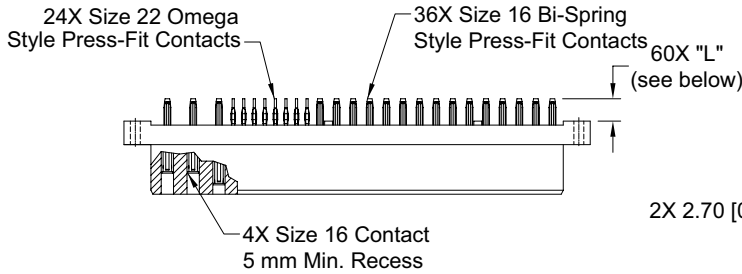

CONNECTOR DIMENSIONS

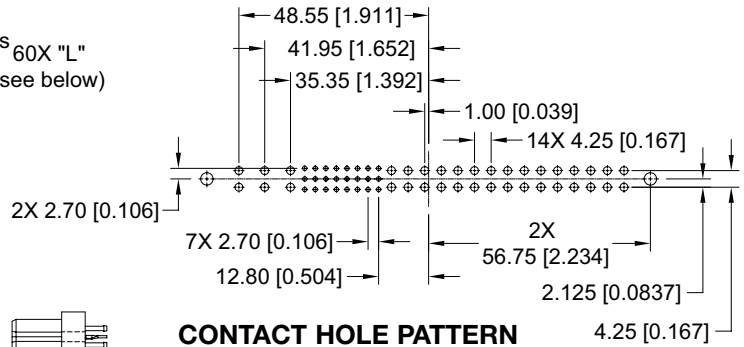

CONTACT HOLE PATTERN

Note: See below for suggested printed board hole sizes, press-fit connector installation tools, and mounting screw options.

CONTACT TAIL LENGTH		
Code	"L" Length	Board Thickness
93	5.72 [0.225]	2.29 to 4.45 [0.090 to 0.175]
94	7.04 [0.277]	4.45 min. [0.175 min.]

MALE COMPLIANT PRESS-FIT CONNECTOR CODE 93 OR 94

STANDARD PART NUMBER

PCIA60W36M9300A1

PCIA60W36M9400A1

Positronic recommends the practice of using mounting hardware to secure connector to printed circuit board.

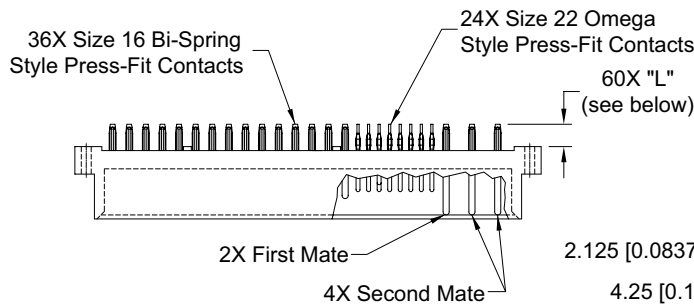

CONNECTOR DIMENSIONS

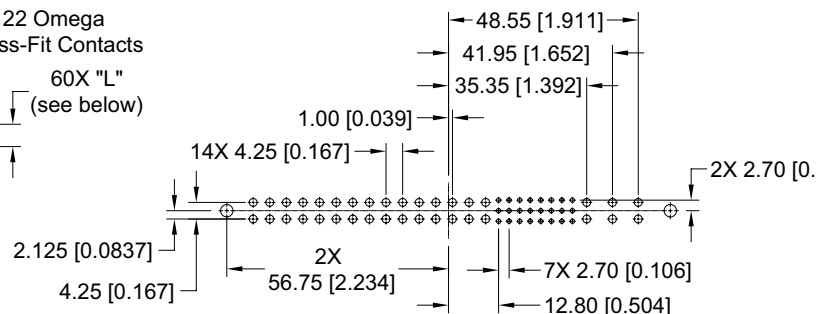

CONTACT HOLE PATTERN

SUGGESTED PRINTED BOARD HOLE SIZES:

Suggest $\varnothing 3.56 \pm 0.08$ [0.140 \pm 0.003] holes for connector mounting holes.

NOTE: See page 105 for suggested printed board drill hole sizes, recommended plating and finished hole sizes for compliant contact termination positions.

For press-fit connector installation tools, see pages 105-106.

For mounting screw options, see page 105.

CONTACT TAIL LENGTH		
Code	"L" Length	Board Thickness
93	5.72 [0.225]	2.29 to 4.45 [0.090 to 0.175]
94	7.04 [0.277]	4.45 min. [0.175 min.]



ORDERING INFORMATION - CODE NUMBERING SYSTEM

Specify Complete Connector By Selecting An Option From Step 1 Through 7

STEP	1	2	3	4	5	6	7	8	9
EXAMPLE	PCIA	60W36	M	93	0	0	A1	/AA	

STEP 1 - BASIC SERIES

PCIA - PCIA Series

STEP 2 - CONNECTOR VARIANTS

60W36 - 36 size 16 contacts and 24 size 22 contacts

60W36R - 36 size 16 contacts and 24 size 22 contacts. Inverted termination style, use with contact Type "4". Currently available in female only.

STEP 3 - CONNECTOR GENDER

- F - Female
- M - Male

STEP 4 - CONTACT TERMINATION TYPE

- 3 - Solder, Straight Printed Board Mount with 4.50 [0.177] tail extension for connection system 1.
- 4 - Solder, Right Angle (90°) Printed Board Mount with 2.68 [0.106] tail extension for connection systems 1, 3 and 4.
- 8 - Contacts must be ordered separately for Panel Mount Cable Connectors, connection system 3, see pages 102-103. Female connector only.
- 93 - Press-Fit, Compliant Termination size 16 and size 22 Straight Printed Board Mount for use with board thicknesses of 2.29 to 4.45 [0.090 to 0.175]. Connection system 1.
- 94 - Press-Fit, Compliant Termination size 16 and size 22 Straight Printed Board Mount for use with board thickness of 4.45 minimum [0.175 minimum]. Connection system 1.

STEP 5 - MOUNTING STYLE

- 0 - Not Applicable
- See page 105 for mounting screw options.

STEP 6 - HOODS

- 0 - Not applicable

STEP 9 - SPECIAL OPTIONS

FOR LISTING OF SPECIAL OPTIONS, SEE SPECIAL OPTIONS APPENDIX ON PAGES 107-108.

STEP 8 - ENVIRONMENTAL COMPLIANCE OPTIONS

/AA - RoHS Compliant

NOTE: If compliance to environmental legislation is not required, this step will not be used. Example: PCIA60W36M9300A1

STEP 7 - CONTACT PLATING FOR PRINTED BOARD TYPE CONNECTORS

- 0 - Crimp contacts ordered separately
- A1 - Gold flash over nickel on mating end and termination end.
- A2 - Gold flash over nickel on mating end and 5.00µ [0.00020 inch] tin-lead solder coat on termination end. Not available with code 93 or code 94 in step 4.
- C1 - 0.76µ [0.000030 inch] gold over nickel on mating end and termination end.
- C2 - 0.76µ [0.000030 inch] gold over nickel on mating end and 5.00µ [0.00020 inch] tin-lead solder coat on termination end. Not available with code 93 or code 94 in step 4.
- D1 - 1.27µ [0.000050 inch] gold over nickel on mating end and termination end.
- D2 - 11.27µ [0.000050 inch] gold over nickel on mating end and 5.00µ [0.00020 inch] tin-lead solder coat on termination end. Not available with code 93 or code 94 in step 4.

NOTE: If you would like a 2D drawing or 3D model, once you've made your connector selection, please visit www.connectpositronic.com. If you can't find your specific part number on our web site, contact Technical Sales to have one created.

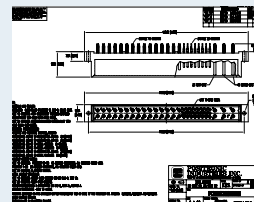

2D Drawing

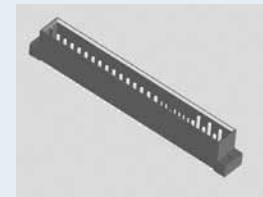

3D model



The PCIM Series encompasses all of the features of the PCIH Series in a smaller package. Reliability, high current capacity and many system management connections make the PCIM Series ideal for use in telecom, computer, information systems and industrial applications.

PCIM SERIES CONTACT VARIANTS

FACE VIEW OF MALE AND REAR VIEW OF FEMALE

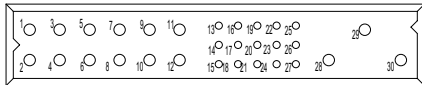

PCIM30W15 VARIANT

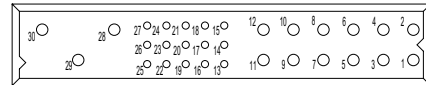

PCIM30W15R VARIANT (Inverted Termination)

15 Size 16 Power Contacts and 15 Size 22 Signal Contacts

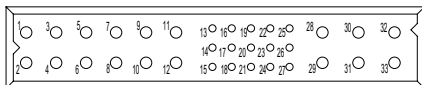

PCIM33W18 VARIANT

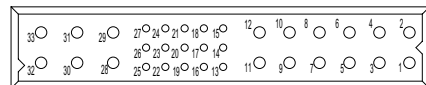

PCIM33W18R VARIANT (Inverted Termination)

18 Size 16 Power Contacts and 15 Size 22 Signal Contacts

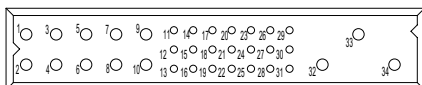

PCIM34W13 VARIANT

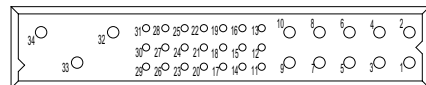

PCIM34W13R VARIANT (Inverted Termination)

13 Size 16 Power Contacts and 21 Size 22 Signal Contacts

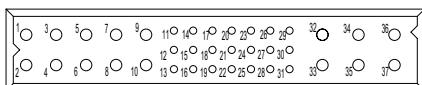

PCIM37W16 VARIANT

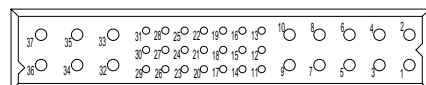

PCIM37W16R VARIANT (Inverted Termination)

16 Size 16 Power Contacts and 21 Size 22 Signal Contacts



MATERIALS AND FINISHES:

Insulator:	Glass-filled polyester, UL 94V-0, blue color.
Contacts:	Size 16 contacts: High conductivity precision- machined copper alloy. Size 22 contacts: Precision-machined copper alloy.
Plating:	Gold flash over nickel. Other plating options available, refer to Step 7 on page 70.
Mounting Screws:	Steel, zinc plated.

ELECTRICAL CHARACTERISTICS:

PCIM Contact Current Ratings, per UL 1977

See Temperature Rise Curves on page 5 for details.

PCIM30W15:

Size 16 Power Contacts: Positions 28, 29, and 30:	45 amperes continuous, all contacts under load.
Positions 1 through 12:	32 amperes continuous, all contacts under load.
Size 22 Signal Contacts:	3 amperes nominal rating.

PCIM33W18:

Size 16 Power Contacts:	30 amperes continuous, all contacts under load.
Size 22 Signal Contacts:	3 amperes nominal rating.

PCIM34W13:

Size 16 Power Contacts: Positions 32, 33, and 34:	45 amperes continuous, all contacts under load.
Positions 1 through 10:	32 amperes continuous, all contacts under load.
Size 22 Signal Contacts:	3 amperes nominal rating.

PCIM37W16:

Size 16 Power Contacts:	30 amperes continuous, all contacts under load.
Size 22 Signal Contacts:	3 amperes nominal rating.

Initial Contact Resistance:

Size 16 Contact:	0.0007 ohms maximum.
Size 22 Contact:	0.005 ohms maximum. Per IEC 512-2, Test 2b.

Insulator Resistance:

5 G ohms per IEC 512-2, Test 3a.

Voltage Proof:

PCIM30W15:

Contacts 28, 29, and 30:	3,000 V r.m.s.
Contacts 1 through 12:	1,500 V r.m.s.
Contacts 13 through 27:	1,000 V r.m.s.

PCIM33W18:

Contacts 1 through 12 and 28 through 33:	1,500 V r.m.s.
Contacts 13 through 27:	1,000 V r.m.s.

PCIM34W13:

Contacts 32, 33, and 34:	3,000 V r.m.s.
Contacts 1 through 10:	1,500 V r.m.s.
Contacts 11 through 31:	1,000 V r.m.s.

PCIM37W16:

Contacts 1 through 10 and 32 through 37:	1,500 V r.m.s.
Contacts 11 through 31:	1,000 V r.m.s.

Creepage and Clearance

Distance; minimum:

PCIM30W15:

Contact 30 to Contact 28:	3.2mm [0.126 inch]
Contact 29 to Contact 28:	3.2mm [0.126 inch]
Contact 30 to Signal Contacts:	6.4mm [0.252 inch]
Contact 29 to Signal Contacts:	6.4mm [0.252 inch]
Contact 30 to Contact 29:	2.5mm [0.098 inch]
Contact 28 to Signal Contacts:	2.0mm [0.079 inch]

PCIM33W18:

Contact 28 to Signal Contacts:	2.0mm [0.079 inch]
--------------------------------	--------------------

PCIM34W13:

Contact 34 to Contact 32:	3.2mm [0.126 inch]
Contact 33 to Contact 32:	3.2mm [0.126 inch]
Contact 34 to Signal Contacts:	6.4mm [0.252 inch]
Contact 33 to Signal Contacts:	6.4mm [0.252 inch]
Contact 34 to Contact 33:	2.5mm [0.098 inch]
Contact 32 to Signal Contacts:	2.0mm [0.079 inch]

PCIM37W16:

Contact 32 to Signal Contacts:	2.0mm [0.079 inch]
--------------------------------	--------------------

Working Voltage:

PCIM30W15:

Contacts 28 through 30:	1,000 V r.m.s.
Contacts 1 through 12:	500 V r.m.s.
Contacts 13 through 27:	333 V r.m.s.

PCIM33W18:

Contacts 1 through 12 and 28 through 33:	500 V r.m.s.
Contacts 13 through 27:	333 V r.m.s.

PCIM34W13:

Contacts 32 through 34:	1,000 V r.m.s.
Contacts 1 through 10:	500 V r.m.s.
Contacts 11 through 31:	333 V r.m.s.

PCIM37W16:

Contacts 1 through 12 and 32 through 37:	500 V r.m.s.
Contacts 13 through 31:	333 V r.m.s.

MECHANICAL CHARACTERISTICS:

Blind Mating System:

Male and female connector bodies provide "lead-in" for 1.3mm [0.050 inch] diametral misalignment.

Polarization:

Provided by connector body design.

Removable Contacts:

Install contact from rear of insulator; release from front of insulator. Size 16 and 22 female contacts feature "Closed Entry" design for highest reliability.

Removable Contact Retention in Connector Body:

Size 16 Contacts:	67 N [15 lbs.]
Size 22 Contacts:	27 N [6 lbs.]

Fixed Contacts:

Printed board terminations, both straight and right angle (90°). Size 16 female contacts feature "Closed Entry" design. Size 22 feature rugged "Open Entry" contact design. "Closed Entry" contacts available, consult Technical Sales.



**Fixed Contact Retention
in Connector Body:**

Size 16 Contacts: 45 N [10 lbs.]
Size 22 Contacts: 27 N [6 lbs.]

Resistance to Solder Heat: 260°C [500°F] for 10 seconds duration per IEC 512-6, Test 12e, 25-watt soldering iron.

Sequential Contact Mating System:

PCIM30W15: First mate contact 28 and last mate contact position 13.
PCIM33W18: Last mate contact position 13.
PCIM34W13: First mate contact 32 and last mate contact position 17.
PCIM37W16: Last mate contact position 17.

Consult Technical Sales for customer specified sequential mating.

Safety "Recessed in Insulator" Contacts:

The following size 16 contacts are recessed 5mm [0.197 inch] below the face of the female connector insulator per safety requirements.

PCIM30W15: Contact positions 29 and 30.
PCIM33W18: None
PCIM34W13: Contact positions 33 and 34.
PCIM37W16: None

Compliant Terminations:

Size 16 and 22 contacts are available with Compliant Contact Terminations. Average insertion and extraction forces of size 16 contacts are 22N (5 lbs.) per contact.

Printed Board Mounting:

Mounting holes provided in connector body for printed board mounting. Self-tapping screws are available.

Mechanical Operations:

250 couplings, minimum.

CLIMATIC CHARACTERISTICS:

Working Temperature: -55°C to +125°C.

**U.L. Recognized File #E49351
CSA Recognized File #LR54219**





PCIM CONNECTOR OUTLINE DIMENSIONS

RIGHT ANGLE (90°) BOARD MOUNT CONNECTOR

FEMALE CONNECTOR

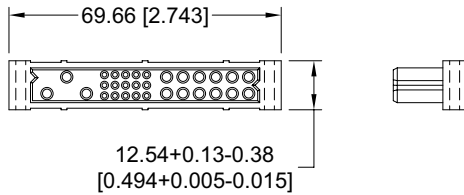
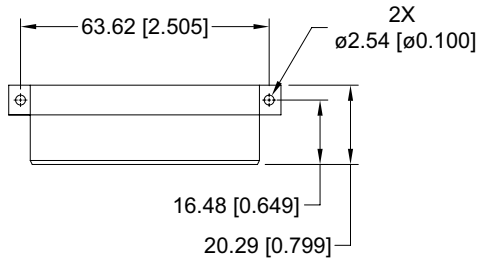

MALE CONNECTOR

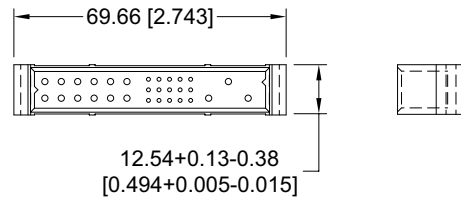
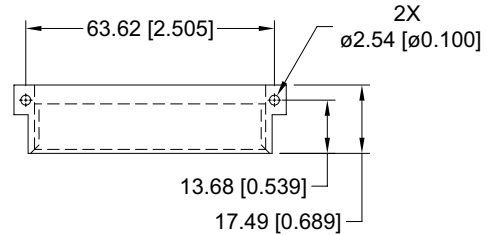

STRAIGHT BOARD MOUNT CONNECTOR

FEMALE CONNECTOR

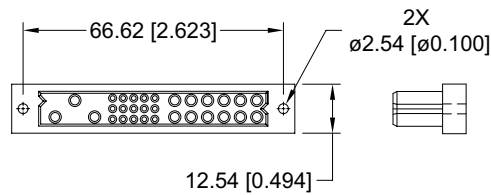
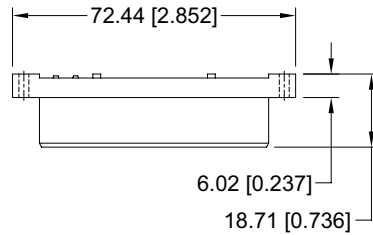

PCIM CONNECTOR MATING DIMENSIONS (FULLY MATED)

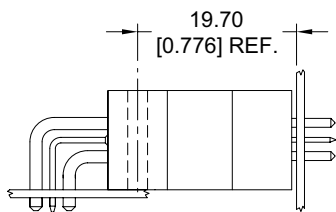

Right Angle (90°) Board
Mount Male to Straight
Board Mount or Panel
Mount Female

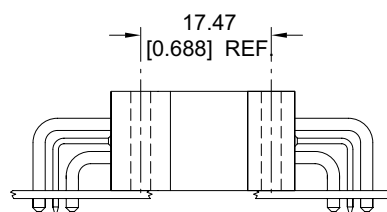

Right Angle (90°)
Board Mount Male to
Right Angle (90°)
Board Mount Female

FEMALE STRAIGHT SOLDER CONNECTOR CODE 3

STANDARD PART NUMBER
PCIM30W15F300A1

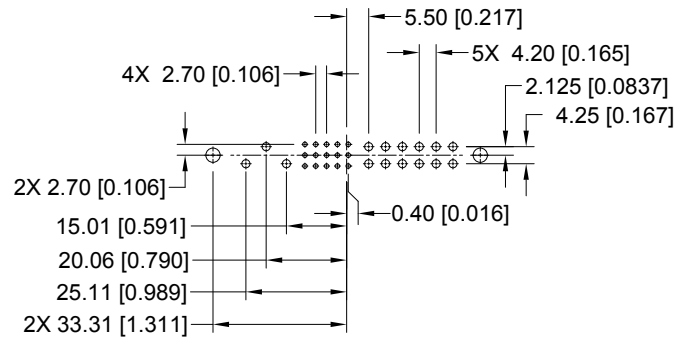
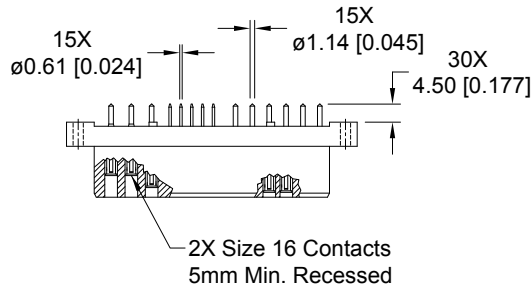

CONTACT HOLE PATTERN

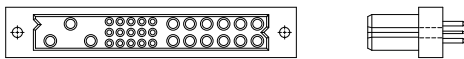

CONNECTOR DIMENSIONS

Note: See below for suggested printed board hole sizes.

FEMALE STRAIGHT SOLDER CONNECTOR CODE 3

STANDARD PART NUMBER
PCIM33W18F300A1

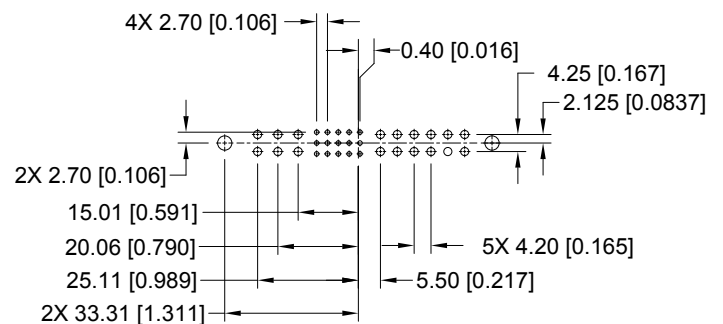
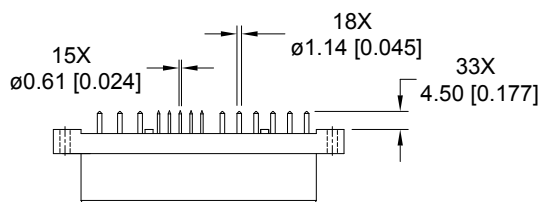

CONTACT HOLE PATTERN

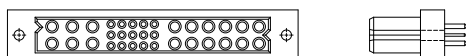

CONNECTOR DIMENSIONS

SUGGESTED PRINTED BOARD HOLE SIZES:

Suggest Ø1.00 [0.039] holes for size 22 contact holes.

Suggest Ø1.60 [0.063] holes for size 16 contact holes.

Suggest Ø3.56±0.08 [0.140±0.003] holes for connector mounting holes.

DIMENSIONS ARE IN MILLIMETERS [INCHES].
ALL DIMENSIONS ARE SUBJECT TO CHANGE. 50



STRAIGHT SOLDER CONNECTOR, FEMALE

FEMALE STRAIGHT SOLDER CONNECTOR WITH A.C. PASS-THROUGH CODE 3 WITH MOS* -246.10

CRIMP CONTACTS ARE NOT SUPPLIED WITH CONNECTOR AND MUST BE ORDERED SEPARATELY

LOW PROFILE PART NUMBER
PCIM33W18F300A1-246.10

For MOS descriptions,
see chart on pages 107-108.

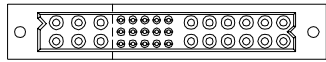
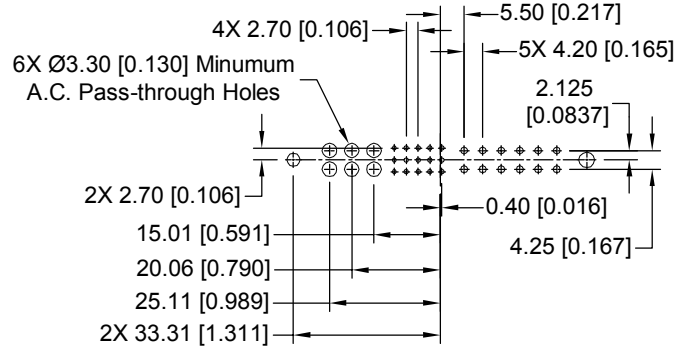
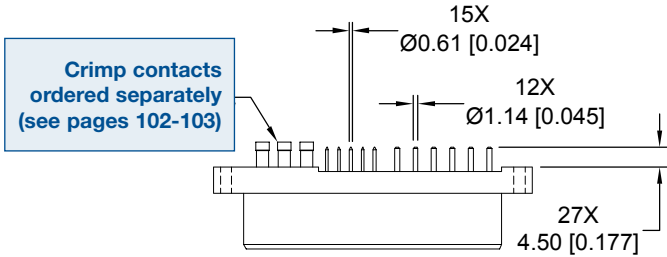

CONNECTOR DIMENSIONS

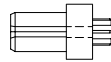

CONTACT HOLE PATTERN

Note: See below for suggested printed board hole sizes.

FEMALE STRAIGHT SOLDER CONNECTOR CODE 3

STANDARD PART NUMBER
PCIM34W13F300A1

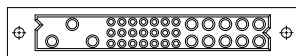
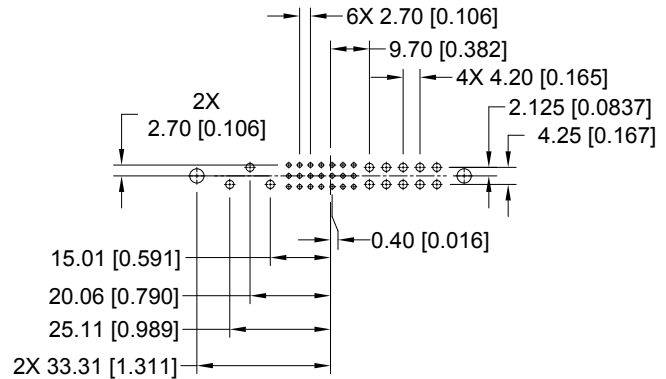
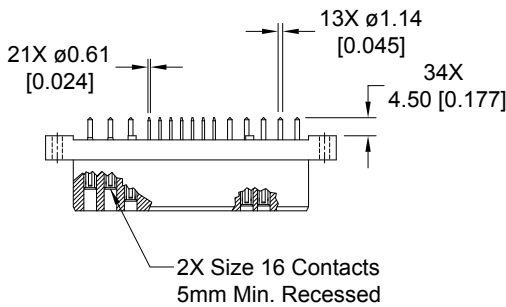

CONNECTOR DIMENSIONS



CONTACT HOLE PATTERN

SUGGESTED PRINTED BOARD HOLE SIZES:

Suggest Ø1.00[0.039] holes for size 22 contact holes.

Suggest Ø1.60 [0.063] holes for size 16 contact holes.

Suggest Ø3.56±0.08 [0.140±0.003] holes for connector mounting holes.

FEMALE STRAIGHT SOLDER CONNECTOR
CODE 3

STANDARD PART NUMBER
PCIM37W16F300A1

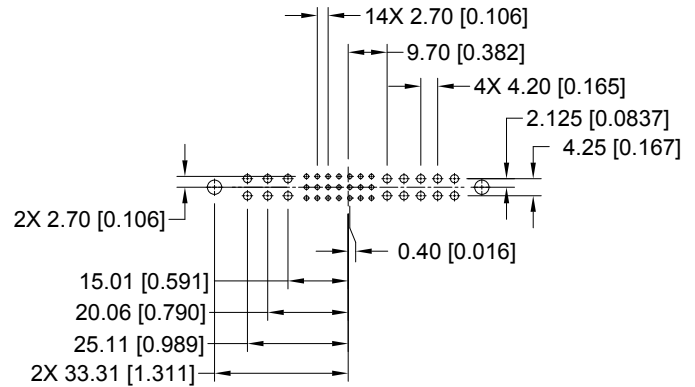
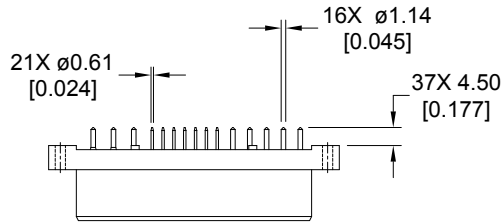

CONTACT HOLE PATTERN

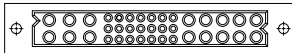

CONNECTOR DIMENSIONS

SUGGESTED PRINTED BOARD HOLE SIZES:

- Suggest $\text{Ø}1.00[0.039]$ holes for size 22 contact holes.
- Suggest $\text{Ø}1.60 [0.063]$ holes for size 16 contact holes.
- Suggest $\text{Ø}3.56\pm0.08 [0.140\pm0.003]$ holes for connector mounting holes.



MALE STRAIGHT SOLDER CONNECTOR CODE 3

STANDARD PART NUMBER
PCIM30W15M300A1

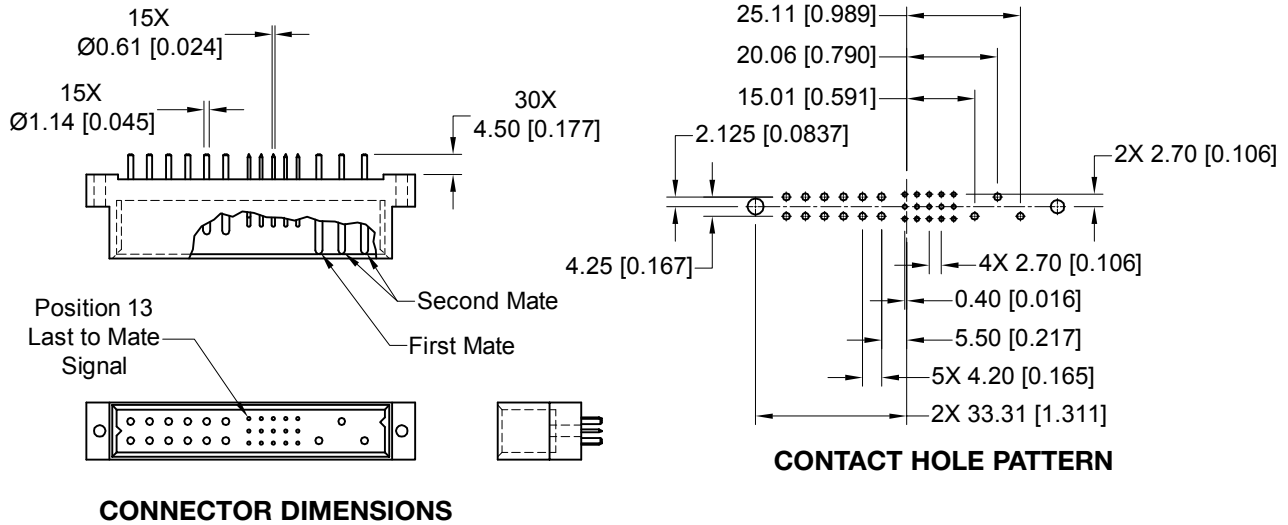

Note: See below for suggested printed board hole sizes.

MALE STRAIGHT SOLDER CONNECTOR CODE 3

STANDARD PART NUMBER
PCIM33W18M300A1

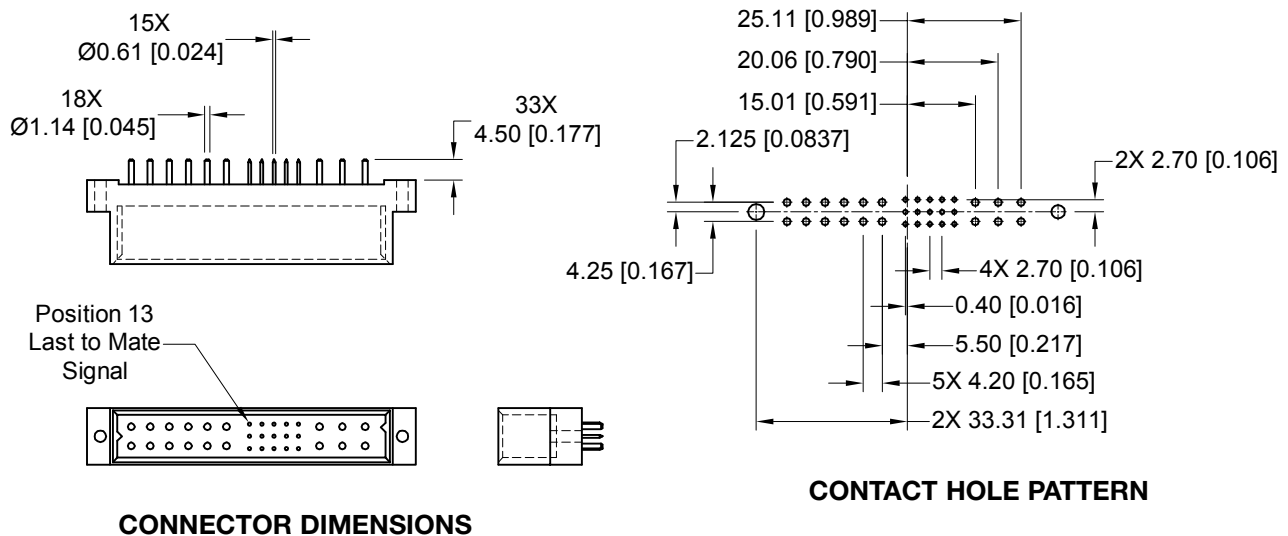

SUGGESTED PRINTED BOARD HOLE SIZES:

Suggest $\text{Ø}1.00 [0.039]$ holes for size 22 contact holes.

Suggest $\text{Ø}1.60 [0.063]$ holes for size 16 contact holes.

Suggest $\text{Ø}3.56\pm0.08 [0.140\pm0.003]$ holes for connector mounting holes.

**MALE STRAIGHT SOLDER CONNECTOR
CODE 3**

STANDARD PART NUMBER
PCIM34W13M300A1

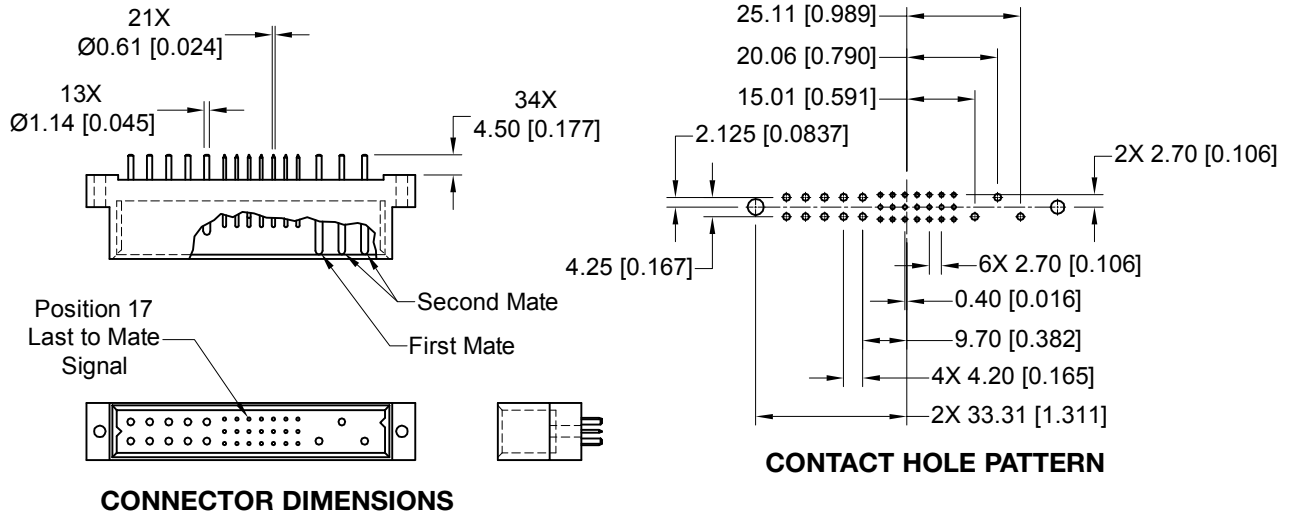

Note: See below for suggested printed board hole sizes.

**MALE STRAIGHT SOLDER CONNECTOR
CODE 3**

STANDARD PART NUMBER
PCIM37W16M300A1

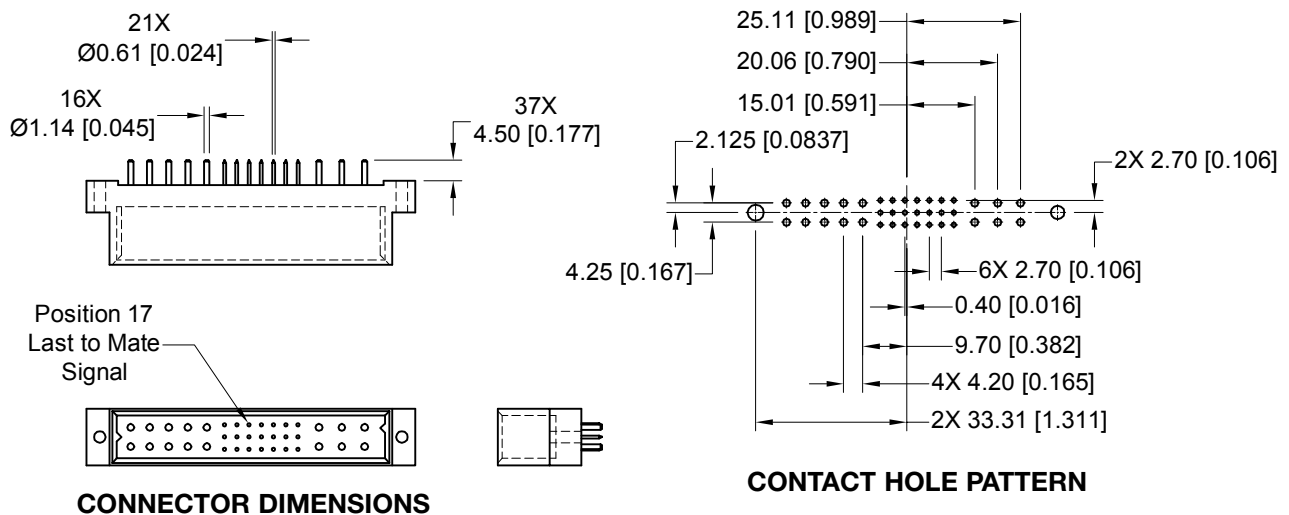

SUGGESTED PRINTED BOARD HOLE SIZES:

Suggest Ø1.00 [0.039] holes for size 22 contact holes.
Suggest Ø1.60 [0.063] holes for size 16 contact holes.
Suggest Ø3.56±0.08 [0.140±0.003] holes for connector mounting holes.



RIGHT ANGLE (90°) BOARD MOUNT CONNECTOR, FEMALE

FEMALE RIGHT ANGLE (90°) BOARD MOUNT CONNECTOR CODE 4

STANDARD PART NUMBER

PCIM30W15F400A1

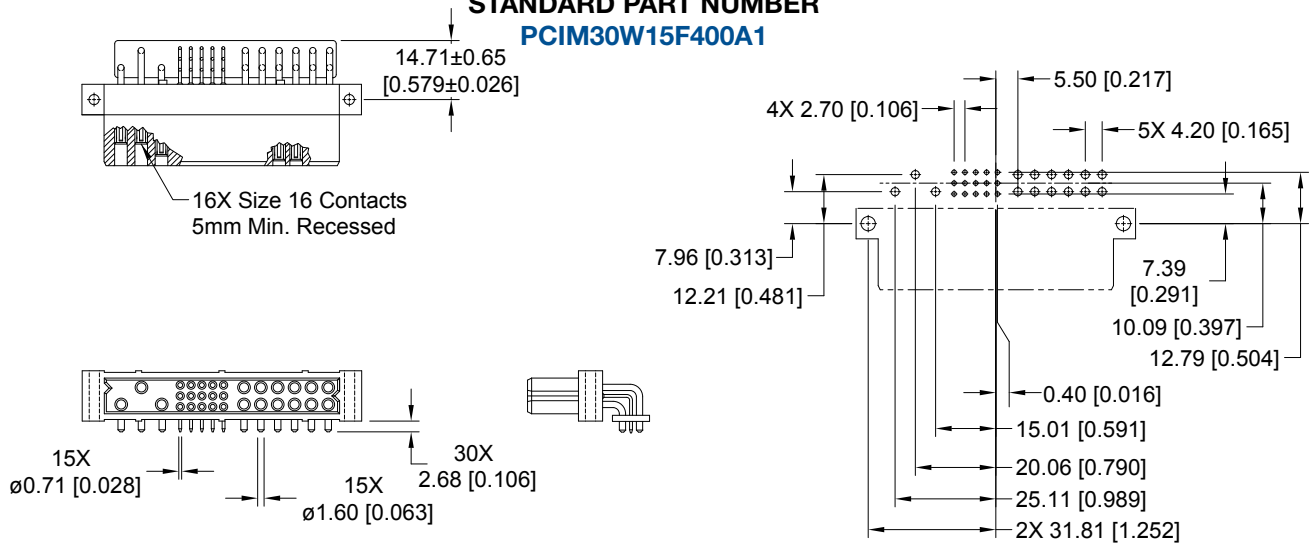

CONNECTOR DIMENSIONS

CONTACT HOLE PATTERN

Note: See below for suggested printed board hole sizes.

INVERTED PA

PCIM30W15F*

FEMALE RIGHT ANGLE (90°) BOARD MOUNT CONNECTOR CODE 4

PART NUMBER FOR INVERTED TERMINATION

PCIM30W15RF400A1

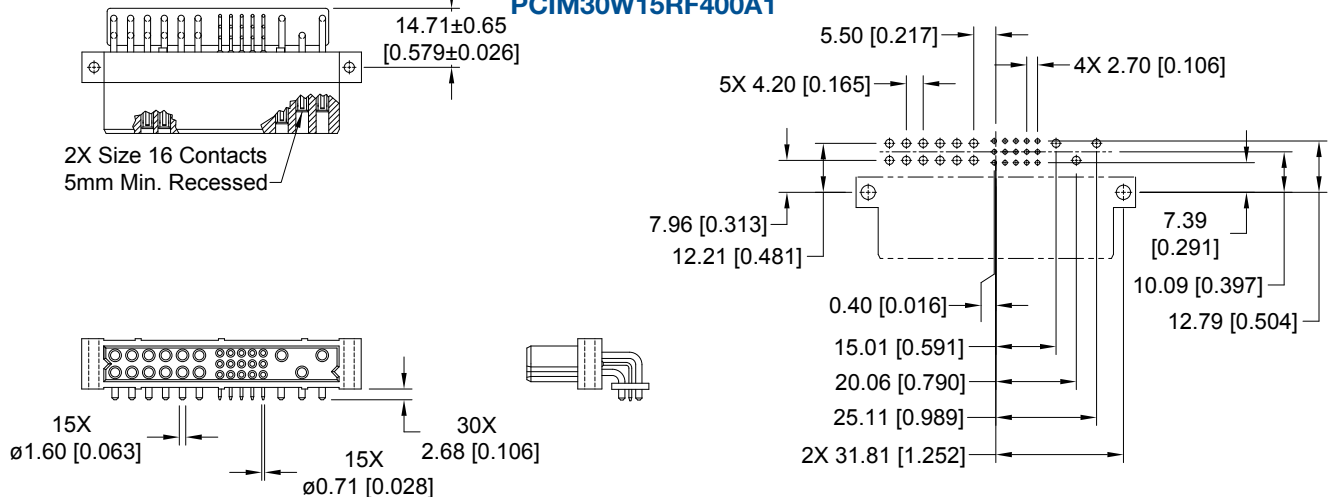

CONNECTOR DIMENSIONS

CONTACT HOLE PATTERN

SUGGESTED PRINTED BOARD HOLE SIZES:

Suggest Ø1.14 [0.045] holes for size 22 contact holes.

Suggest Ø2.03 [0.080] holes for size 16 contact holes.

Suggest Ø3.56±0.08 [0.140±0.003] holes for connector mounting holes.

**FEMALE RIGHT ANGLE (90°) BOARD MOUNT CONNECTORS
CODE 4**

STANDARD PART NUMBER

PCIM33W18F400A1

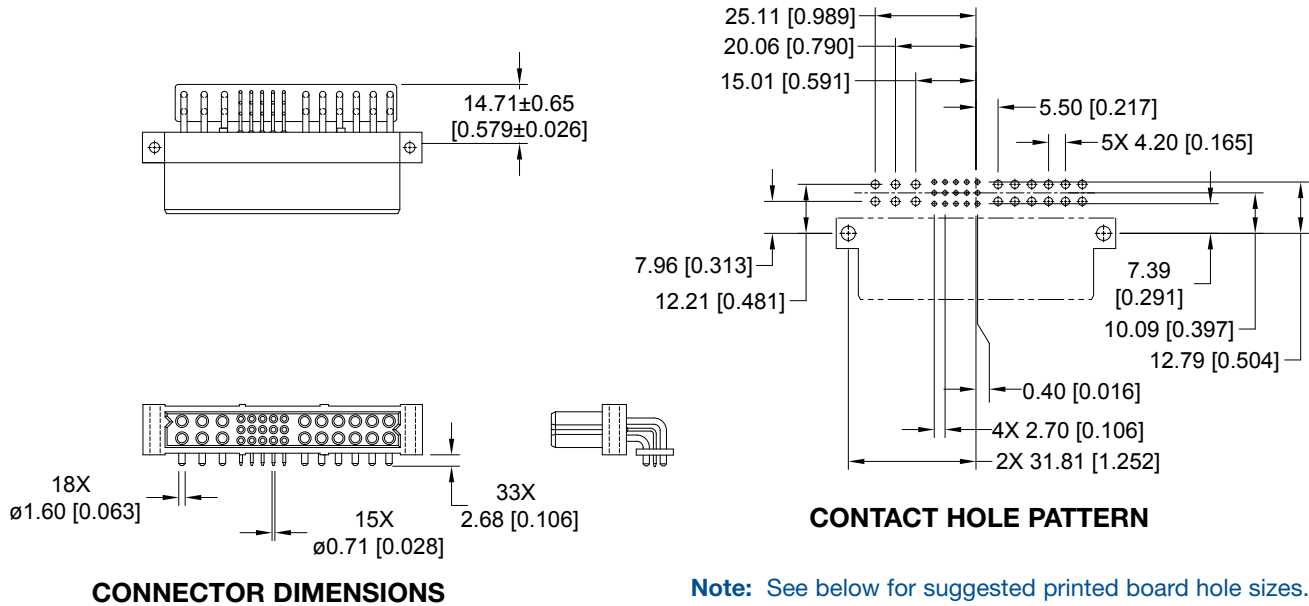

**FEMALE RIGHT ANGLE (90°) BOARD MOUNT CONNECTORS
CODE 4**

PART NUMBER FOR INVERTED TERMINATION

PCIM33W18RF400A1

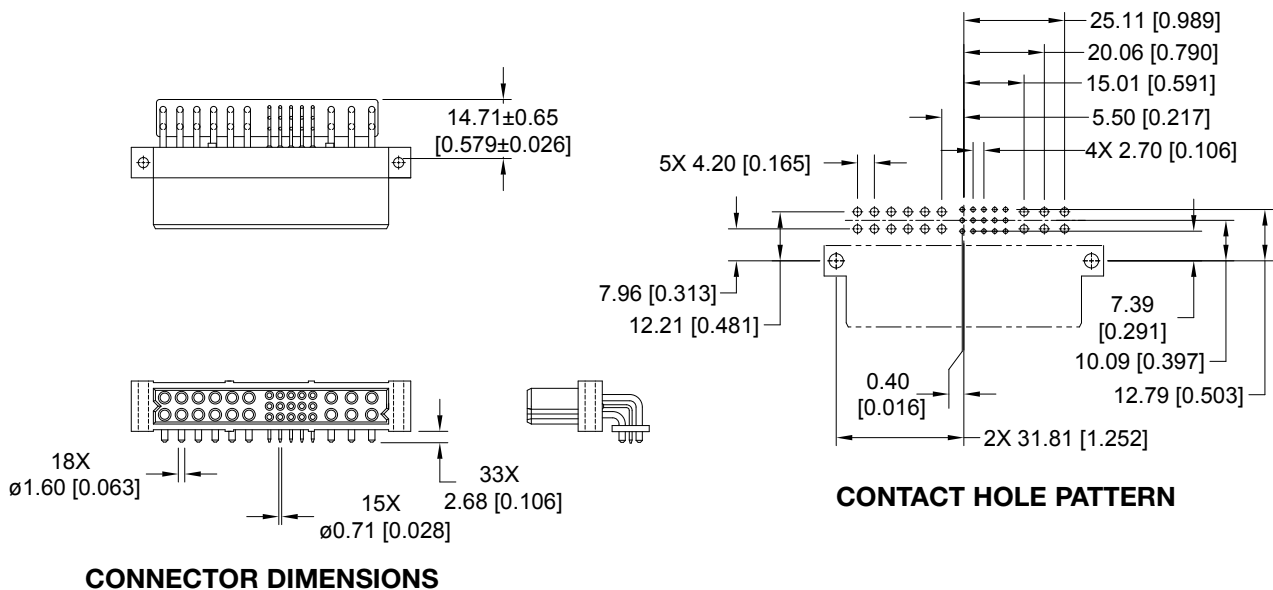

SUGGESTED PRINTED BOARD HOLE SIZES:

- Suggest $\varnothing 1.14$ [0.045] holes for size 22 contact holes.
- Suggest $\varnothing 2.03$ [0.080] holes for size 16 contact holes.
- Suggest $\varnothing 3.56 \pm 0.08$ [0.140 ± 0.003] holes for connector mounting holes.



RIGHT ANGLE (90°) BOARD MOUNT CONNECTOR, FEMALE

FEMALE RIGHT ANGLE (90°) BOARD MOUNT CONNECTOR CODE 4

STANDARD PART NUMBER
PCIM34W13F400A1

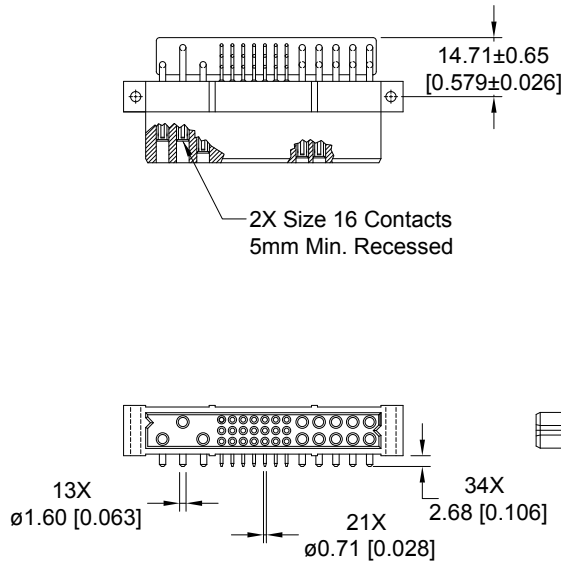

CONNECTOR DIMENSIONS

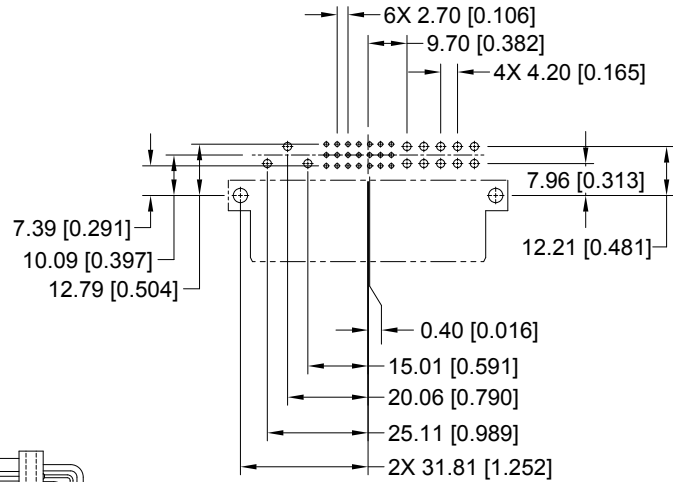

CONTACT HOLE PATTERN

Note: See below for suggested printed board hole sizes.

FEMALE RIGHT ANGLE (90°) BOARD MOUNT CONNECTOR CODE 4

PART NUMBER FOR INVERTED TERMINATION
PCIM34W13RF400A1

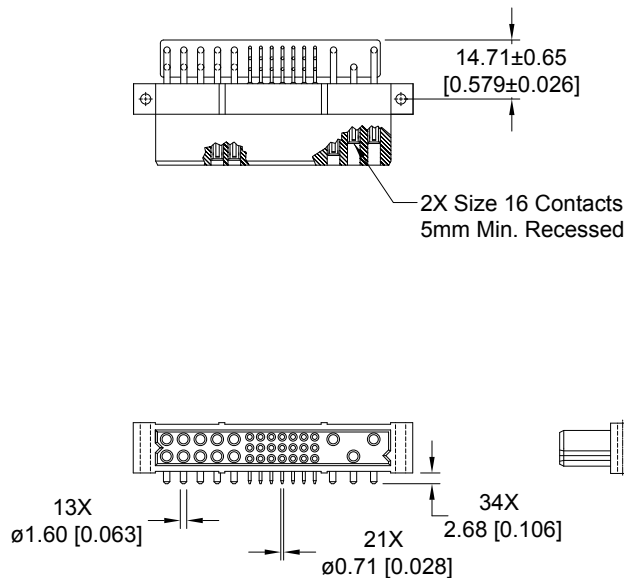

CONNECTOR DIMENSIONS

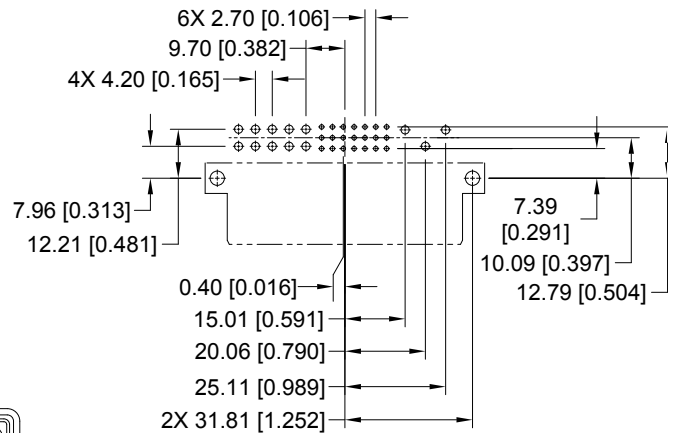

CONTACT HOLE PATTERN

SUGGESTED PRINTED BOARD HOLE SIZES:

Suggest Ø1.14 [0.045] holes for size 22 contact holes.

Suggest Ø2.03 [0.080] holes for size 16 contact holes.

Suggest Ø3.56±0.08 [0.140±0.003] holes for connector mounting holes.

**FEMALE RIGHT ANGLE (90°) BOARD MOUNT CONNECTOR
CODE 4**

**STANDARD PART NUMBER
PCIM37W16F400A1**

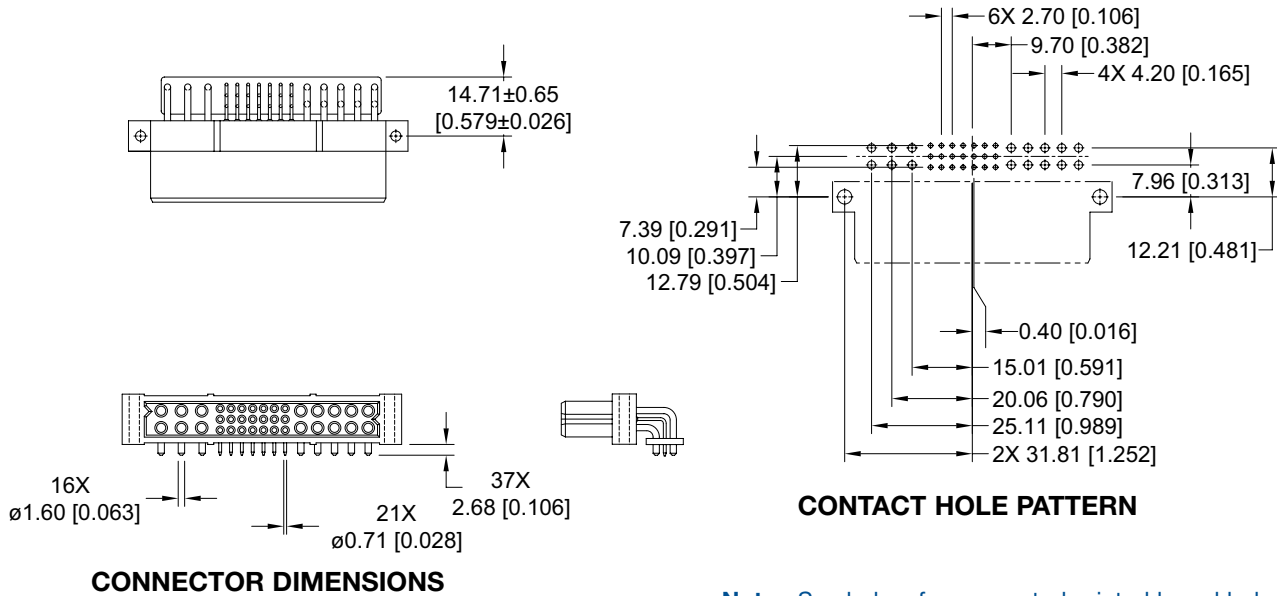

Note: See below for suggested printed board hole sizes.

**FEMALE RIGHT ANGLE (90°) BOARD MOUNT CONNECTOR
CODE 4**

**PART NUMBER FOR INVERTED TERMINATION
PCIM37W16RF400A1**

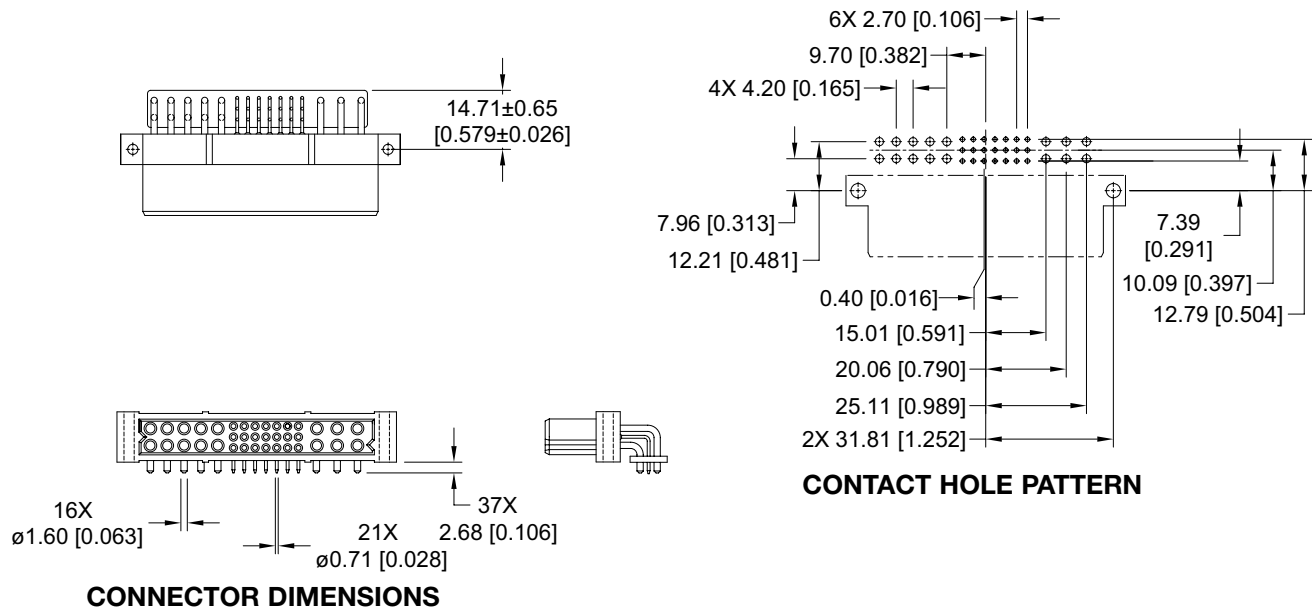

SUGGESTED PRINTED BOARD HOLE SIZES:

- Suggest Ø1.14 [0.045] holes for size 22 contact holes.
- Suggest Ø2.03 [0.080] holes for size 16 contact holes.
- Suggest Ø3.56±0.08 [0.140±0.003] holes for connector mounting holes.



RIGHT ANGLE (90°) BOARD MOUNT CONNECTOR, MALE

MALE RIGHT ANGLE (90°) BOARD MOUNT CONNECTOR CODE 4

STANDARD PART NUMBER
PCIM30W15M400A1

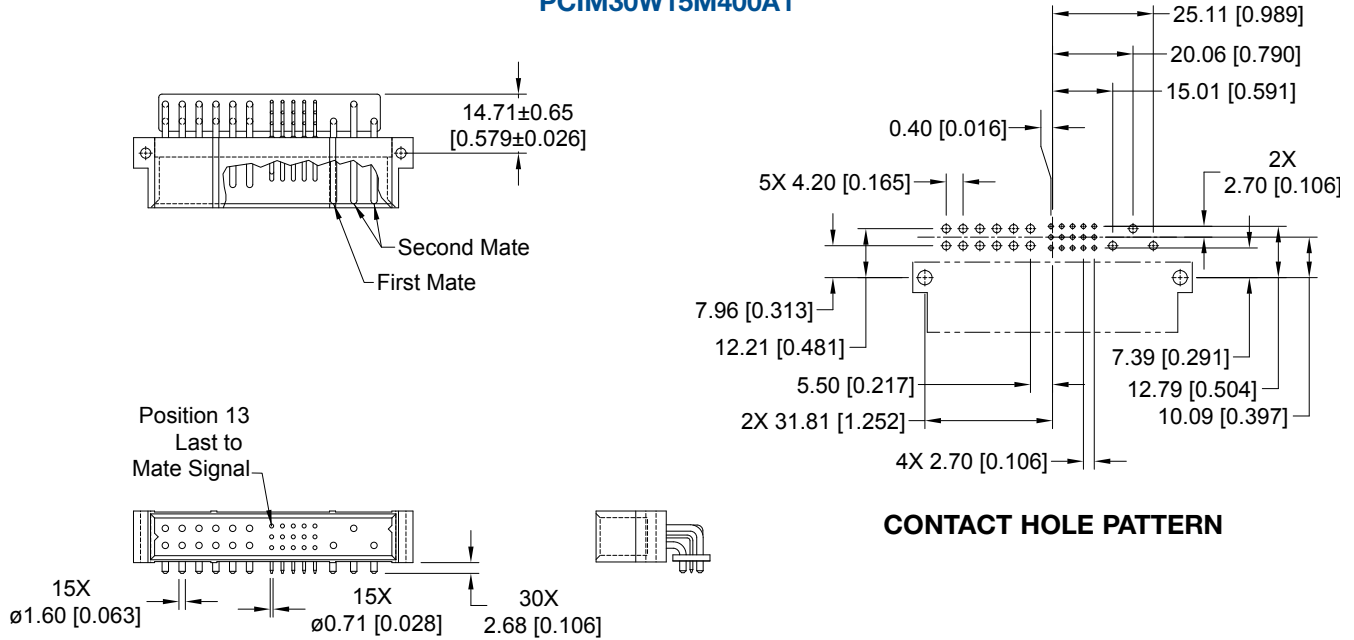

Note: See below for suggested printed board hole sizes.

MALE RIGHT ANGLE (90°) BOARD MOUNT CONNECTOR CODE 4

PART NUMBER FOR INVERTED TERMINATION
PCIM30W15RM400A1

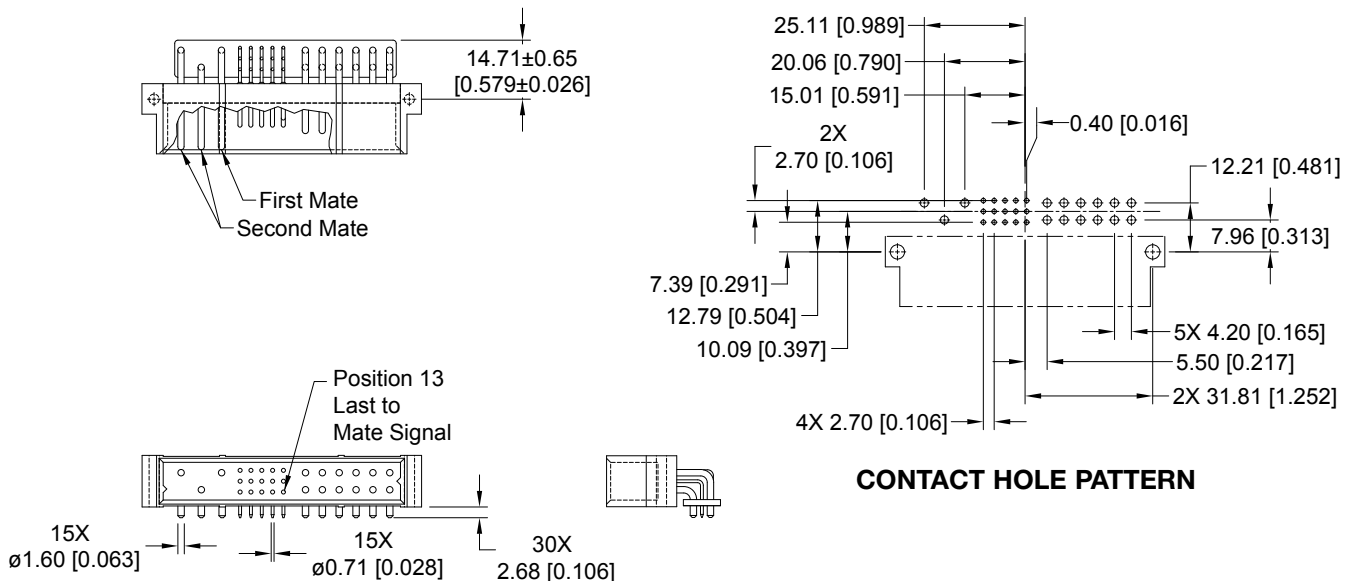

SUGGESTED PRINTED BOARD HOLE SIZES:

Suggest Ø1.14 [0.045] holes for size 22 contact holes.

Suggest Ø2.03 [0.080] holes for size 16 contact holes.

Suggest Ø3.56±0.08 [0.140±0.003] holes for connector mounting holes.

**MALE RIGHT ANGLE (90°) BOARD MOUNT CONNECTOR
CODE 4**

**STANDARD PART NUMBER:
PCIM33W18M400A1**

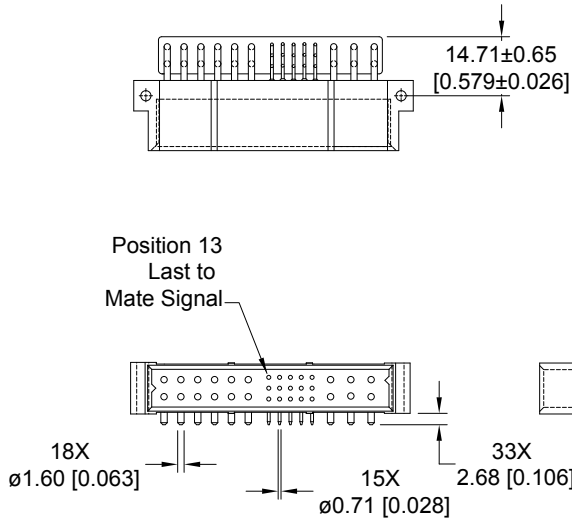

CONNECTOR DIMENSIONS

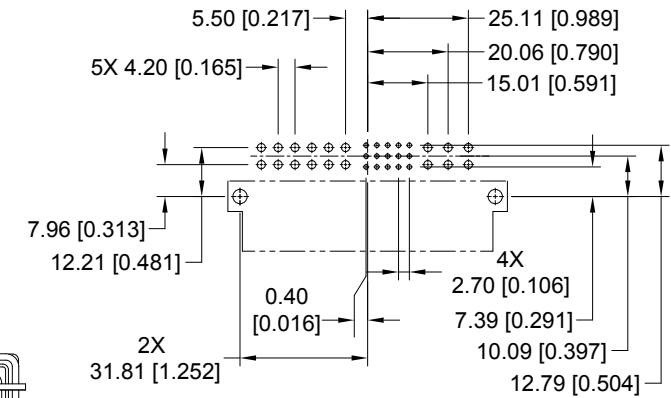

CONTACT HOLE PATTERN

Note: See below for suggested printed board hole sizes.

**MALE RIGHT ANGLE (90°) BOARD MOUNT CONNECTOR
CODE 4**

**PART NUMBER FOR INVERTED TERMINATION
PCIM33W18RM400A1**

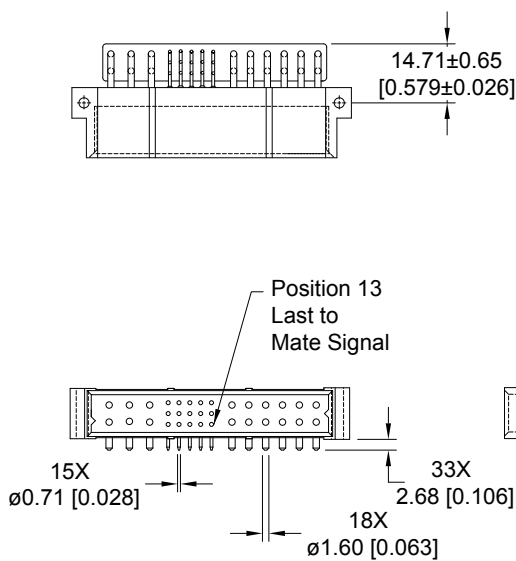

CONNECTOR DIMENSIONS

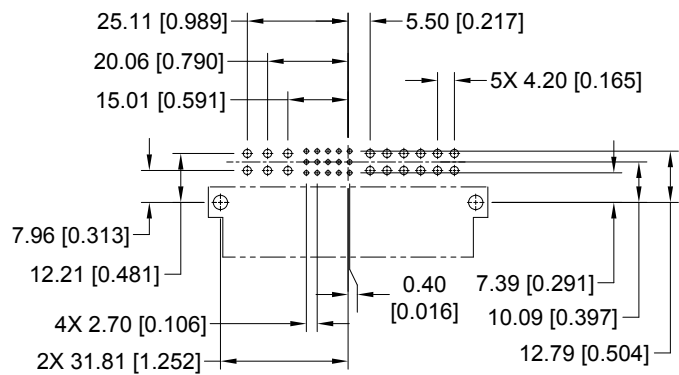

CONTACT HOLE PATTERN

SUGGESTED PRINTED BOARD HOLE SIZES:

Suggest $\text{Ø}1.14$ [0.045] holes for size 22 contact holes.
Suggest $\text{Ø}2.03$ [0.080] holes for size 16 contact holes.
Suggest $\text{Ø}3.56\pm0.08$ [0.140±0.003] holes for connector mounting holes.



RIGHT ANGLE (90°) BOARD MOUNT CONNECTOR, MALE

MALE RIGHT ANGLE (90°) BOARD MOUNT CONNECTOR CODE 4

STANDARD PART NUMBER:
PCIM34W13M400A1

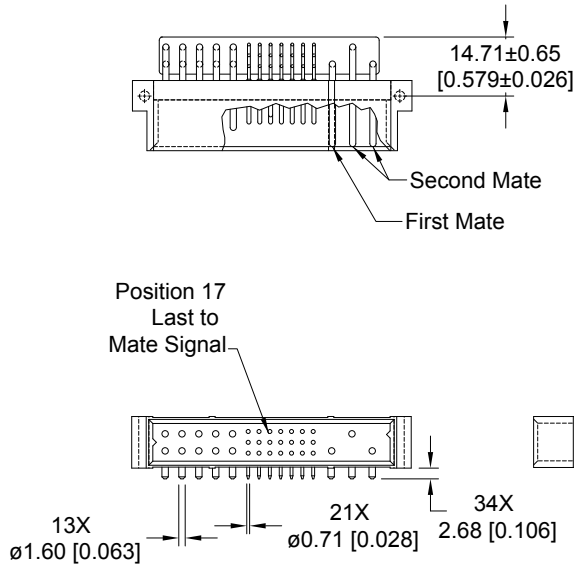

CONNECTOR DIMENSIONS

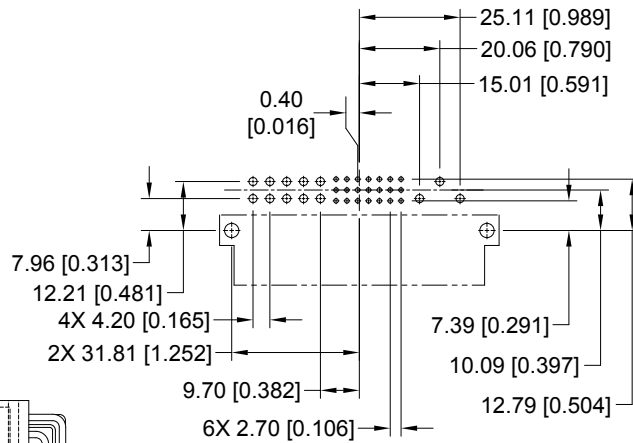

CONTACT HOLE PATTERN

Note: See below for suggested printed board hole sizes.

MALE RIGHT ANGLE (90°) BOARD MOUNT CONNECTOR CODE 4

PART NUMBER FOR INVERTED TERMINATION:
PCIM34W13RM400A1

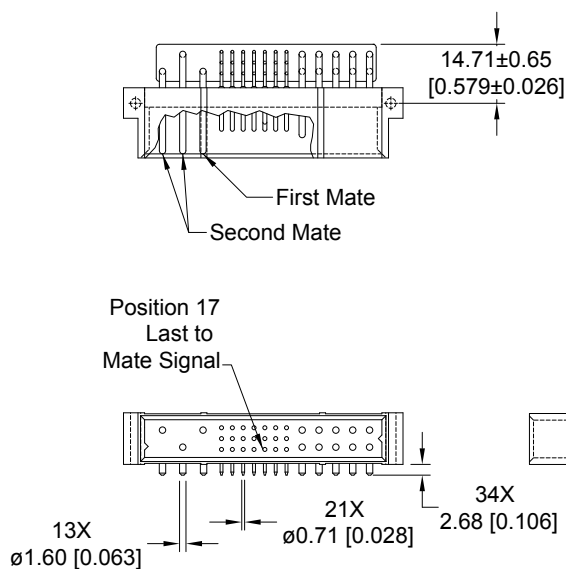

CONNECTOR DIMENSIONS

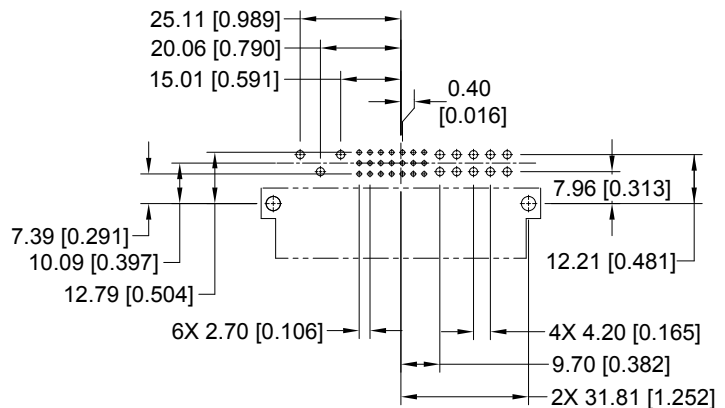

CONTACT HOLE PATTERN

SUGGESTED PRINTED BOARD HOLE SIZES:

- Suggest Ø1.14 [0.045] holes for size 22 contact holes.
- Suggest Ø2.03 [0.080] holes for size 16 contact holes.
- Suggest Ø3.56±0.08 [0.140±0.003] holes for connector mounting holes.

**MALE RIGHT ANGLE (90°) BOARD MOUNT CONNECTOR
CODE 4**

**STANDARD PART NUMBER
PCIM37W16M400A1**

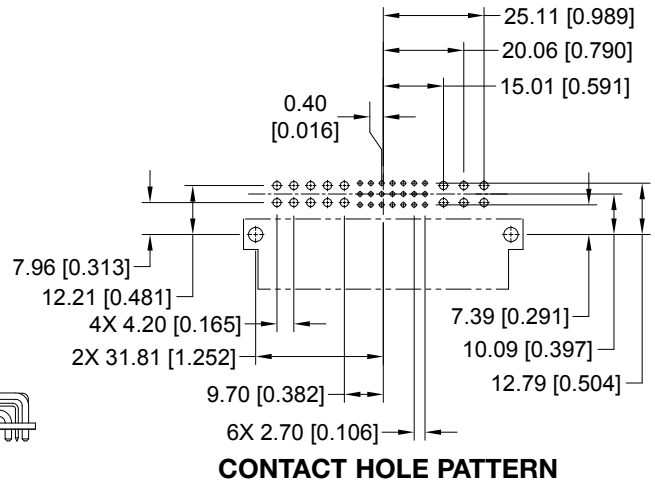
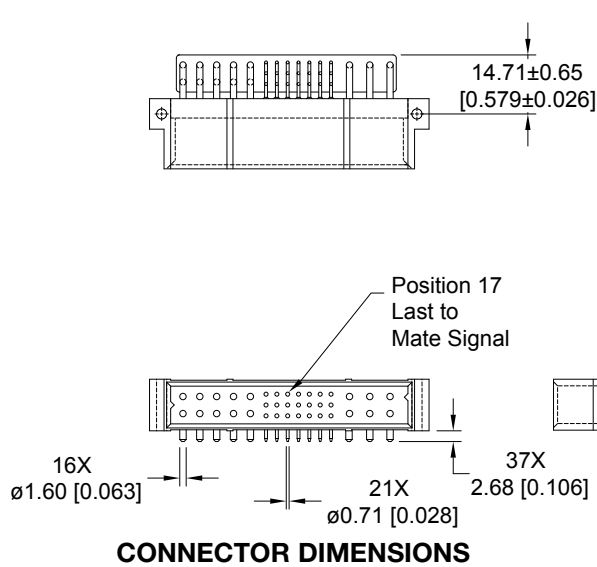

Note: See below for suggested printed board hole sizes.

**MALE RIGHT ANGLE (90°) BOARD MOUNT CONNECTOR
CODE 4**

**PART NUMBER FOR INVERTED TERMINATION
PCIM37W16RM400A1**

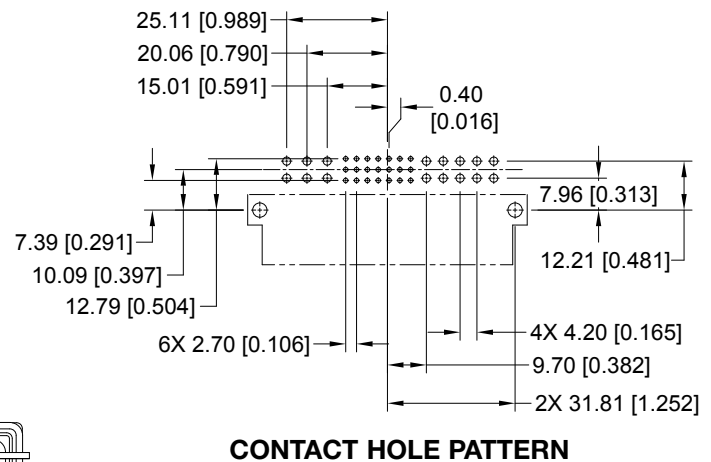
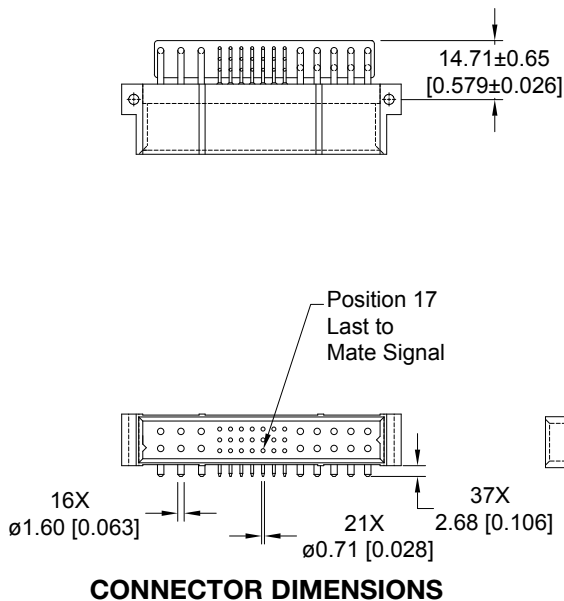

SUGGESTED PRINTED BOARD HOLE SIZES:

- Suggest Ø1.14 [0.045] holes for size 22 contact holes.
- Suggest Ø2.03 [0.080] holes for size 16 contact holes.
- Suggest Ø3.56±0.08 [0.140±0.003] holes for connector mounting holes.



FEMALE PANEL MOUNT CRIMP CONTACT CONNECTOR CODE 8

CONTACTS ARE NOT SUPPLIED WITH CONNECTOR AND MUST BE ORDERED SEPARATELY

STANDARD PART NUMBER
PCIM30W15F8000

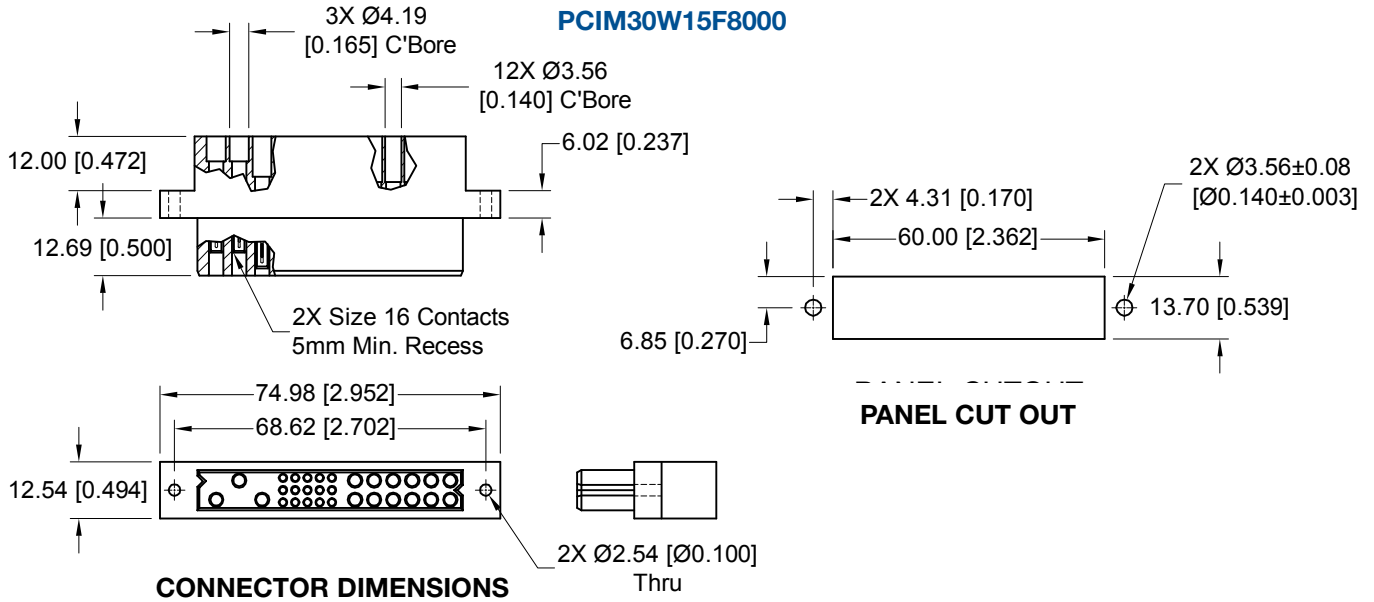

FEMALE PANEL MOUNT CRIMP CONTACT CONNECTOR CODE 8

CONTACTS ARE NOT SUPPLIED WITH CONNECTOR AND MUST BE ORDERED SEPARATELY

STANDARD PART NUMBER
PCIM33W18F8000

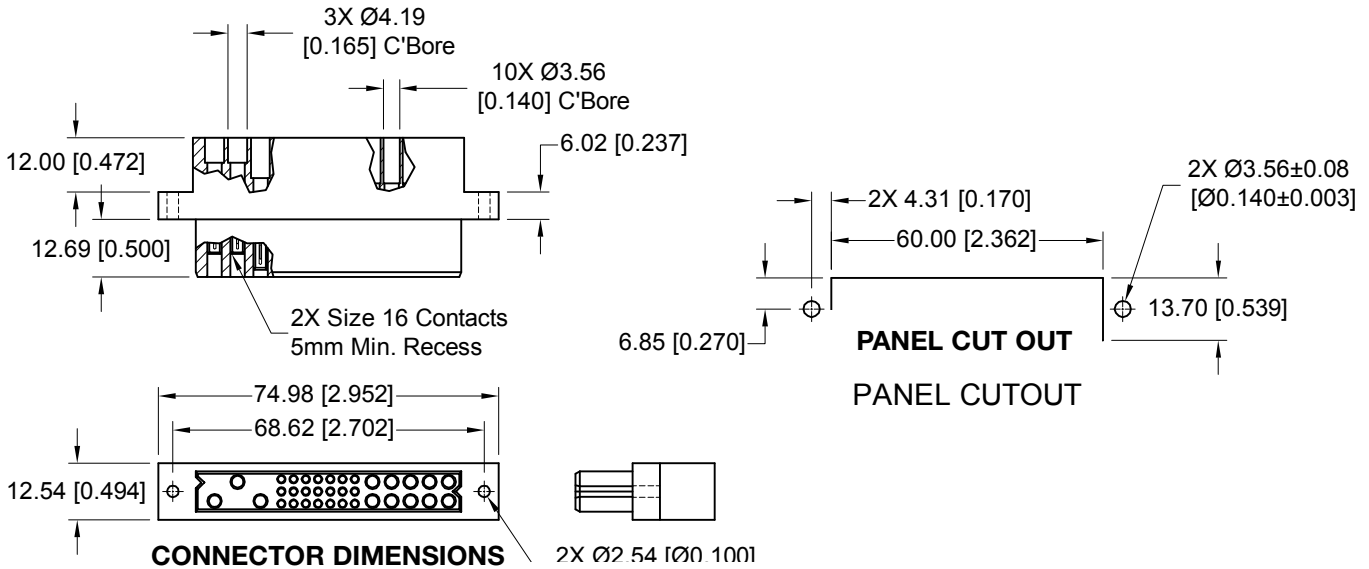

For information regarding removable contacts, see Removable Contact section, pages 102-103.

**FEMALE PANEL MOUNT CRIMP CONTACT CONNECTOR
CODE 8**

CONTACTS ARE NOT SUPPLIED WITH CONNECTOR AND MUST BE ORDERED SEPARATELY

STANDARD PART NUMBER

PCIM34W13F8000

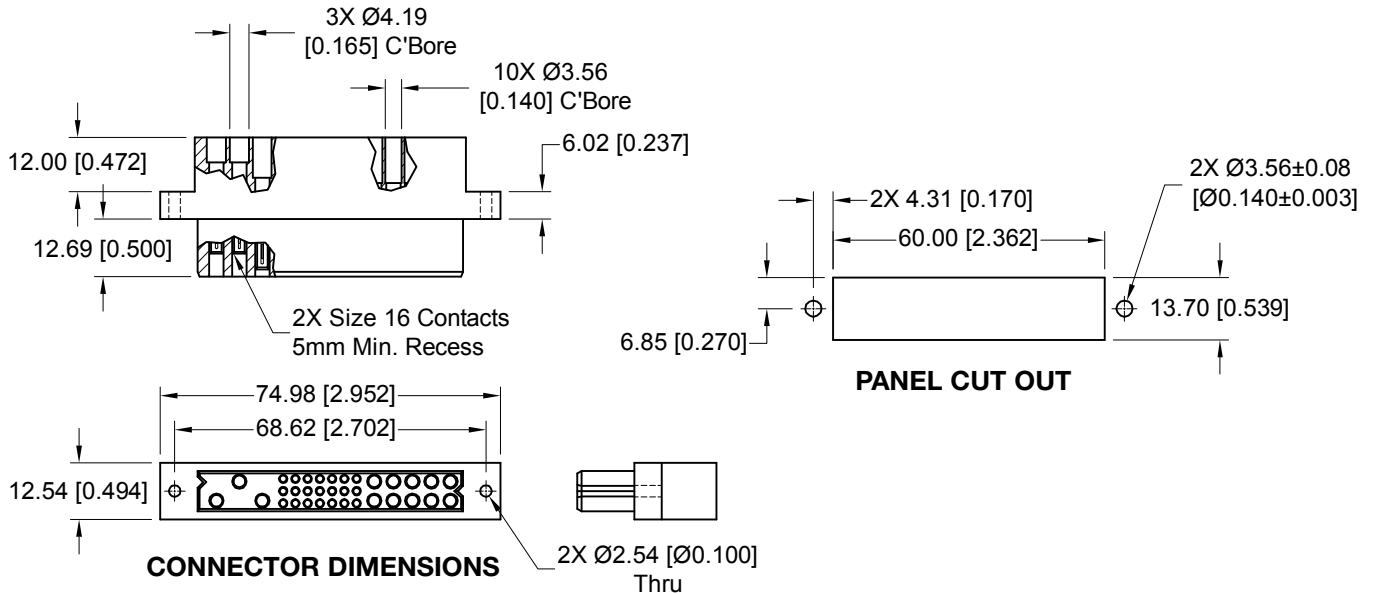

**FEMALE PANEL MOUNT CRIMP CONTACT CONNECTOR
CODE 8**

CONTACTS ARE NOT SUPPLIED WITH CONNECTOR AND MUST BE ORDERED SEPARATELY

STANDARD PART NUMBER

PCIM37W16F8000

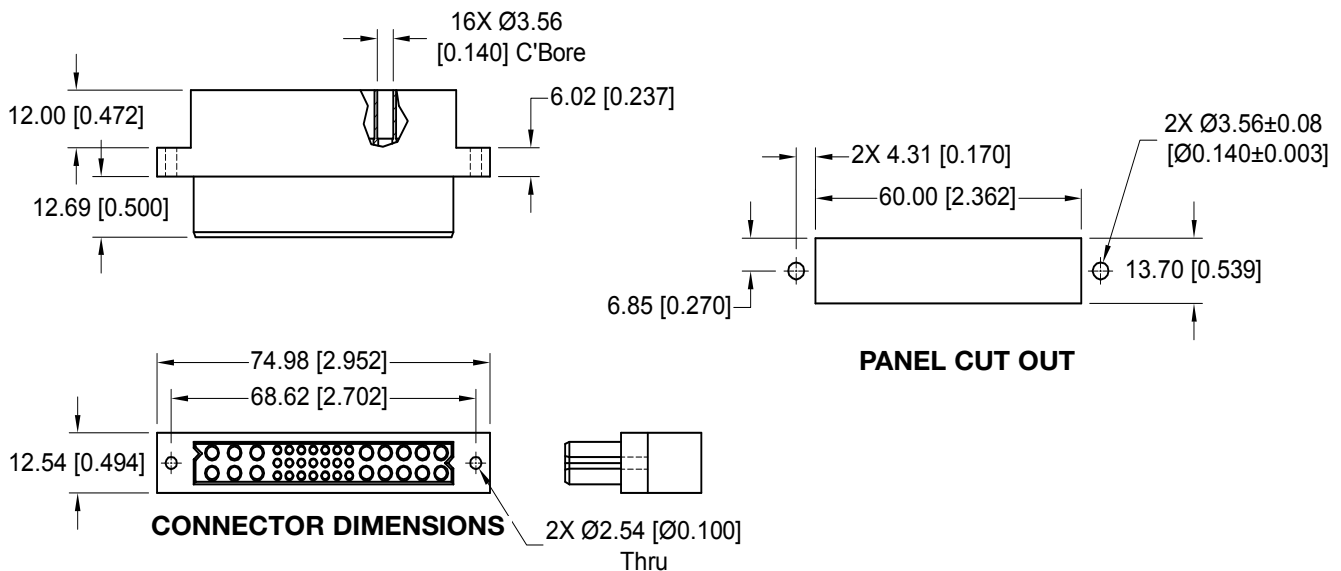

For information regarding removable contacts, see Removable Contact section, pages 102-103.



COMPLIANT PRESS-FIT BOARD MOUNT CONNECTOR, FEMALE

FEMALE COMPLIANT PRESS-FIT CONNECTOR CODE 93 OR 94

STANDARD PART NUMBER
PCIM30W15F9300A1
PCIM30W15F9400A1

Positronic recommends the practice of using mounting hardware to secure connector to printed circuit board.

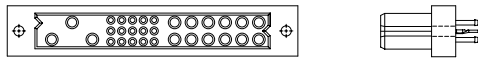
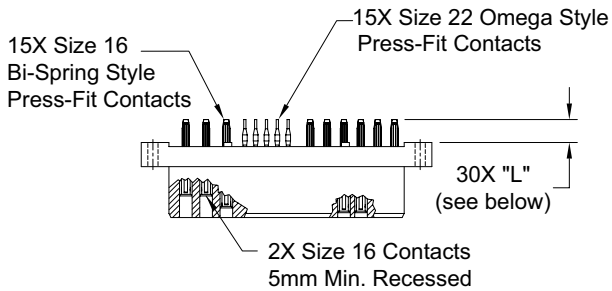

CONNECTOR DIMENSIONS

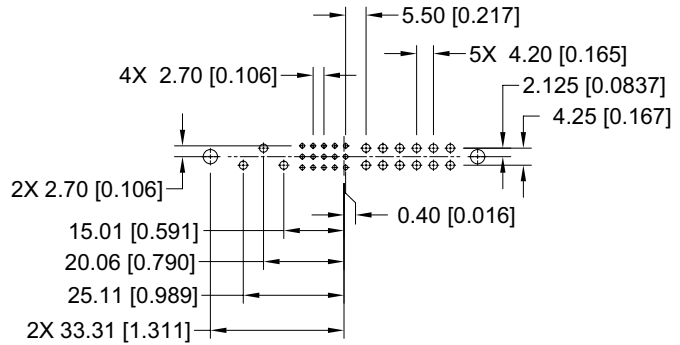

CONTACT HOLE PATTERN

CONTACT TAIL LENGTH		
Code	"L" Length	Board Thickness
93	5.72 [0.225]	2.29 to 4.45 [0.090 to 0.175]
94	7.04 [0.277]	4.45 min. [0.175 min.]

Note: See below for suggested printed board hole sizes, press-fit connector installation tools, and mounting screw options.

FEMALE COMPLIANT PRESS-FIT CONNECTOR CODE 93 OR 94

STANDARD PART NUMBER
PCIM33W18F9300A1
PCIM33W18F9400A1

Positronic recommends the practice of using mounting hardware to secure connector to printed circuit board.

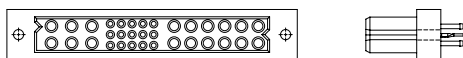
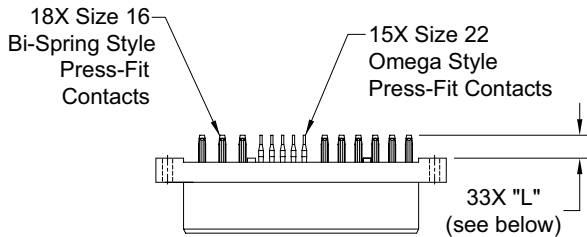

CONNECTOR DIMENSIONS

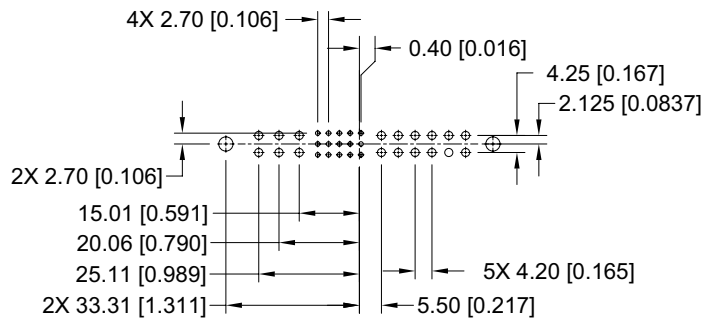

CONTACT HOLE PATTERN

CONTACT TAIL LENGTH		
Code	"L" Length	Board Thickness
93	5.72 [0.225]	2.29 to 4.45 [0.090 to 0.175]
94	7.04 [0.277]	4.45 min. [0.175 min.]

SUGGESTED PRINTED BOARD HOLE SIZES:

Suggest $\varnothing 3.56 \pm 0.08$ [0.140 \pm 0.003] holes for connector mounting holes.

NOTE: See page 105 for suggested printed board drill hole sizes, recommended plating and finished hole sizes for compliant contact termination positions.

For press-fit connector installation tools, see pages 105-106.

For mounting screw options, see page 105.



FEMALE COMPLIANT PRESS-FIT CONNECTOR WITH A.C. PASS-THROUGH CODE 93 OR 94 WITH MOS* -246.10

CRIMP CONTACTS ARE NOT SUPPLIED WITH CONNECTOR AND MUST BE ORDERED SEPARATELY

* For MOS descriptions,
see chart on pages 107-108.

LOW PROFILE PART NUMBER
PCIM33W18F9300A1-246.10
PCIM33W18F9400A1-246.10

Positronic recommends the practice
of using mounting hardware to secure
connector to printed circuit board.

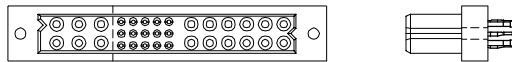
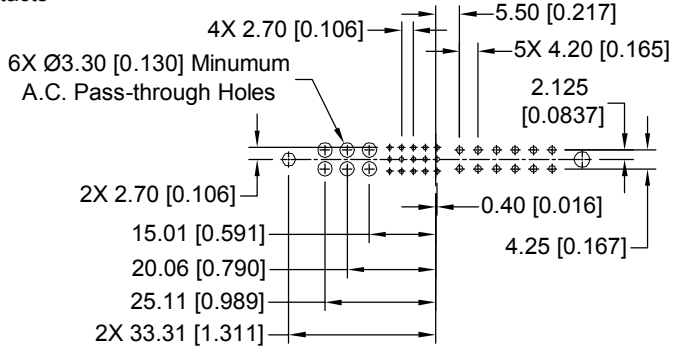
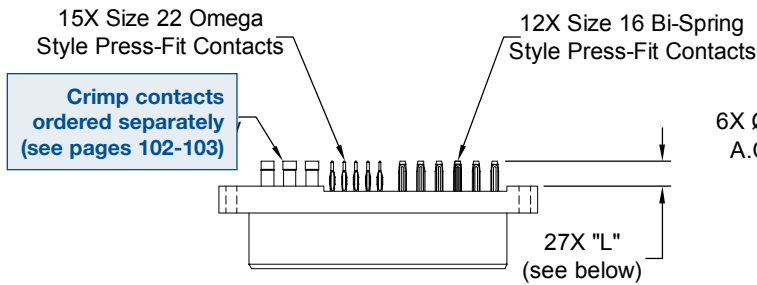

CONNECTOR DIMENSIONS

CONTACT HOLE PATTERN

CONTACT TAIL LENGTH		
Code	"L" Length	Board Thickness
93	5.72 [0.225]	2.29 to 4.45 [0.090 to 0.175]
94	7.04 [0.277]	4.45 min. [0.175 min.]

Note: See below for suggested printed board hole sizes, press-fit connector installation tools, and mounting screw options.

FEMALE COMPLIANT PRESS-FIT CONNECTOR CODE 93 OR 94

STANDARD PART NUMBER
PCIM34W13F9300A1
PCIM34W13F9400A1

Positronic recommends the practice
of using mounting hardware to secure
connector to printed circuit board.

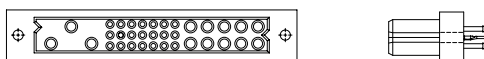
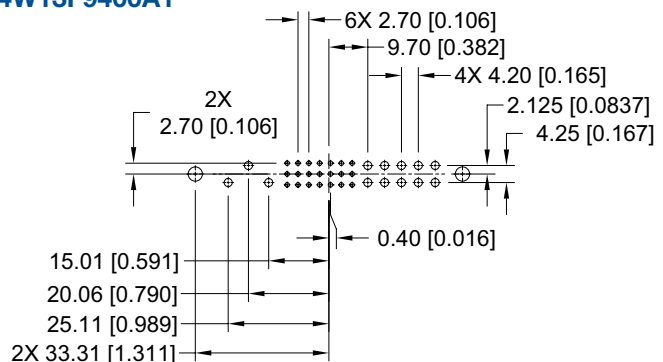
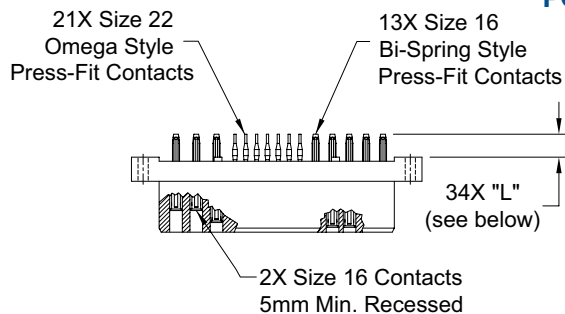

CONNECTOR DIMENSIONS

CONTACT HOLE PATTERN

CONTACT TAIL LENGTH		
Code	"L" Length	Board Thickness
93	5.72 [0.225]	2.29 to 4.45 [0.090 to 0.175]
94	7.04 [0.277]	4.45 min. [0.175 min.]

SUGGESTED PRINTED BOARD HOLE SIZES:

Suggest $\text{Ø}3.56 \pm 0.08$ [0.140 ± 0.003] holes for connector mounting holes.

NOTE: See page 105 for suggested printed board drill hole sizes, recommended plating and finished hole sizes for compliant contact termination positions.

For press-fit connector installation tools, see pages 105-106.

For mounting screw options, see page 105.

DIMENSIONS ARE IN MILLIMETERS [INCHES].
ALL DIMENSIONS ARE SUBJECT TO CHANGE.



Positronic
connectpositronic.com

COMPLIANT PRESS-FIT BOARD MOUNT CONNECTOR, FEMALE

Compact
Power
Connectors

FEMALE COMPLIANT PRESS-FIT CONNECTOR CODE 93 OR 94

STANDARD PART NUMBER

PCIM37W16F9300A1

PCIM37W16F9400A1

Positronic recommends the practice of using mounting hardware to secure connector to printed circuit board.

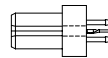
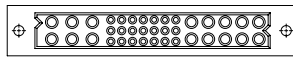
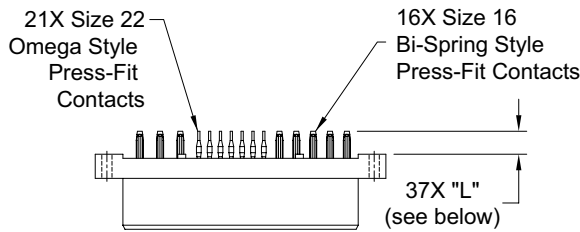

CONNECTOR DIMENSIONS

CONTACT TAIL LENGTH		
Code	"L" Length	Board Thickness
93	5.72 [0.225]	2.29 to 4.45 [0.090 to 0.175]
94	7.04 [0.277]	4.45 min. [0.175 min.]

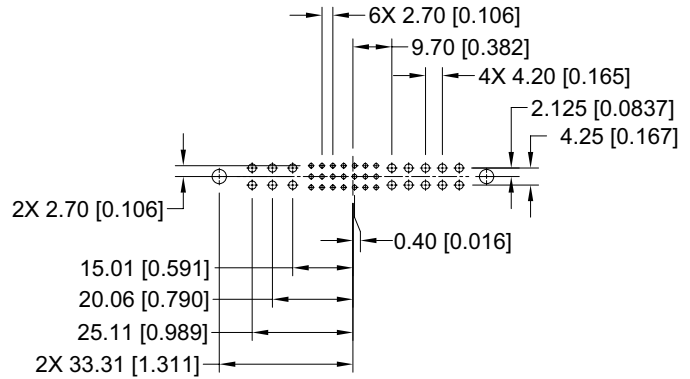

CONTACT HOLE PATTERN

SUGGESTED PRINTED BOARD HOLE SIZES:

Suggest $\varnothing 3.56 \pm 0.08$ [0.140 \pm 0.003] holes for connector mounting holes.

NOTE: See page 105 for suggested printed board drill hole sizes, recommended plating and finished hole sizes for compliant contact termination positions.

For press-fit connector installation tools, see pages 105-106.

For mounting screw options, see page 105.



MALE COMPLIANT PRESS-FIT CONNECTOR CODE 93 OR 94

STANDARD PART NUMBER

PCIM30W15M9300A1

PCIM30W15M9400A1

Positronic recommends the practice of using mounting hardware to secure connector to printed circuit board.

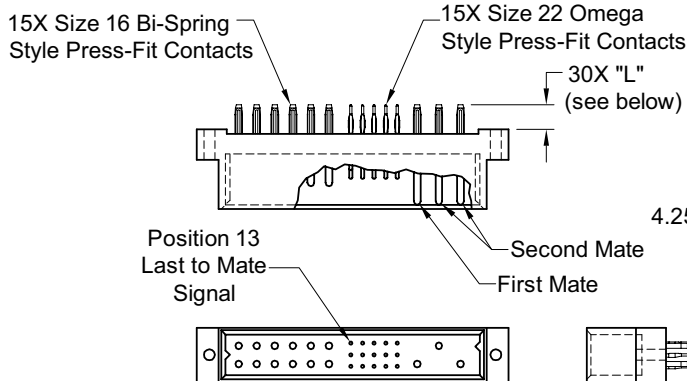

CONNECTOR DIMENSIONS

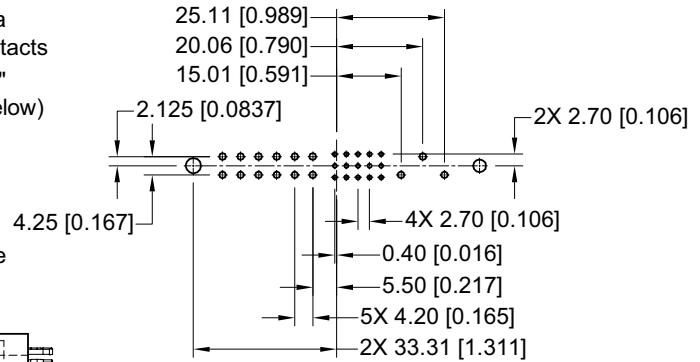

CONTACT HOLE PATTERN

CONTACT TAIL LENGTH		
Code	"L" Length	Board Thickness
93	5.72 [0.225]	2.29 to 4.45 [0.090 to 0.175]
94	7.04 [0.277]	4.45 min. [0.175 min.]

Note: See below for suggested printed board hole sizes, press-fit connector installation tools, and mounting screw options.



MALE COMPLIANT PRESS-FIT CONNECTOR CODE 93 OR 94

STANDARD PART NUMBER

PCIM33W18M9300A1

PCIM33W18M9400A1

Positronic recommends the practice of using mounting hardware to secure connector to printed circuit board.

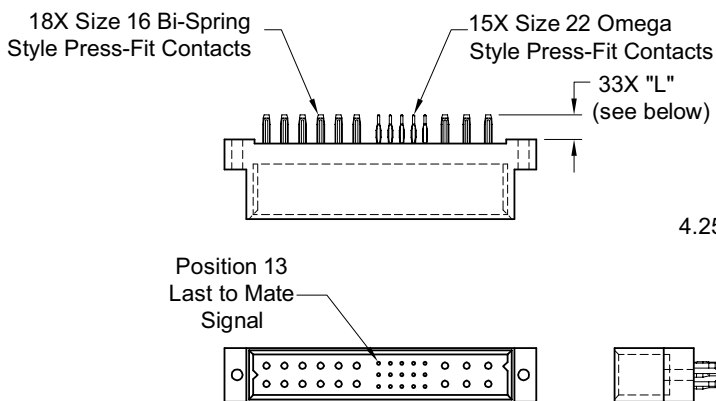

CONNECTOR DIMENSIONS

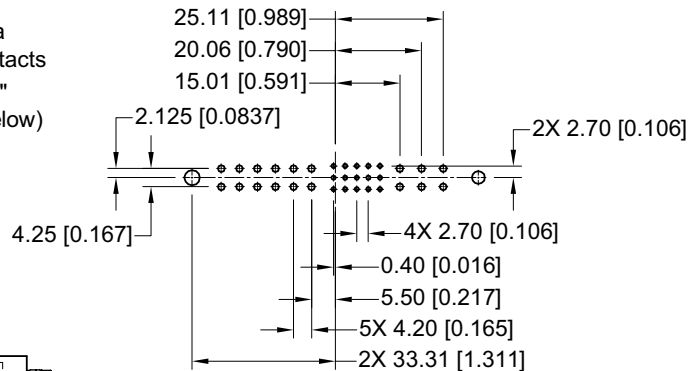

CONTACT HOLE PATTERN

SUGGESTED PRINTED BOARD HOLE SIZES:

Suggest $\varnothing 3.56 \pm 0.08$ [0.140 \pm 0.003] holes for connector mounting holes.

NOTE: See page 105 for suggested printed board drill hole sizes, recommended plating and finished hole sizes for compliant contact termination positions.

For press-fit connector installation tools, see pages 105-106.

For mounting screw options, see page 105.

CONTACT TAIL LENGTH		
Code	"L" Length	Board Thickness
93	5.72 [0.225]	2.29 to 4.45 [0.090 to 0.175]
94	7.04 [0.277]	4.45 min. [0.175 min.]

DIMENSIONS ARE IN MILLIMETERS [INCHES].
ALL DIMENSIONS ARE SUBJECT TO CHANGE. 68



COMPLIANT PRESS-FIT BOARD MOUNT CONNECTOR, MALE

MALE COMPLIANT PRESS-FIT CONNECTOR CODE 93 OR 94

STANDARD PART NUMBER
PCIM34W13M9300A1
PCIM34W13M9400A1

Positronic recommends the practice of using mounting hardware to secure connector to printed circuit board.

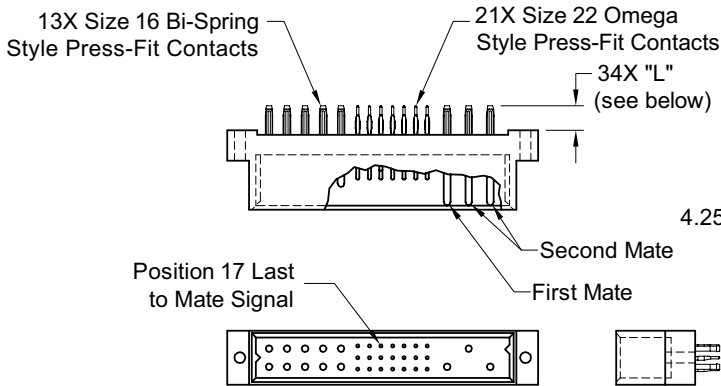

CONNECTOR DIMENSIONS

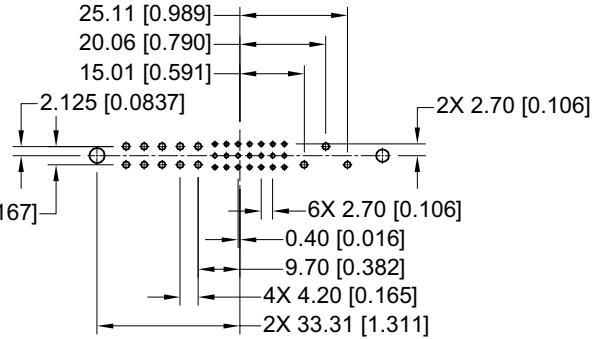

CONTACT HOLE PATTERN

Note: See below for suggested printed board hole sizes, press-fit connector installation tools, and mounting screw options.

CONTACT TAIL LENGTH		
Code	"L" Length	Board Thickness
93	5.72 [0.225]	2.29 to 4.45 [0.090 to 0.175]
94	7.04 [0.277]	4.45 min. [0.175 min.]

MALE COMPLIANT PRESS-FIT CONNECTOR CODE 93 OR 94

STANDARD PART NUMBER
PCIM37W16M9300A1
PCIM37W16M9400A1

Positronic recommends the practice of using mounting hardware to secure connector to printed circuit board.

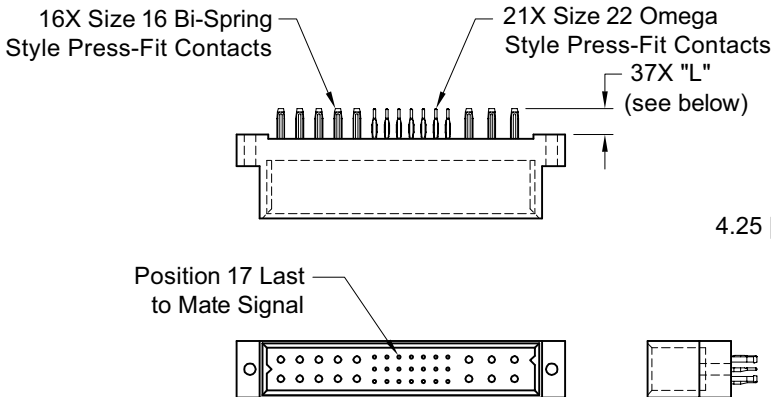

CONNECTOR DIMENSIONS

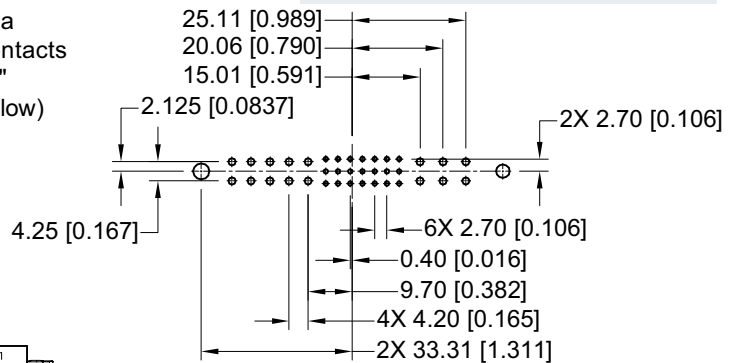

CONTACT HOLE PATTERN

CONTACT TAIL LENGTH		
Code	"L" Length	Board Thickness
93	5.72 [0.225]	2.29 to 4.45 [0.090 to 0.175]
94	7.04 [0.277]	4.45 min. [0.175 min.]

SUGGESTED PRINTED BOARD HOLE SIZES:

Suggest $\varnothing 3.56 \pm 0.08$ [0.140 \pm 0.003] holes for connector mounting holes.

NOTE: See page 105 for suggested printed board drill hole sizes, recommended plating and finished hole sizes for compliant contact termination positions.

For press-fit connector installation tools, see pages 105-106.

For mounting screw options, see page 105.



ORDERING INFORMATION - CODE NUMBERING SYSTEM

Specify Complete Connector By Selecting An Option From Step 1 Through 7

STEP	1	2	3	4	5	6	7	8	9
EXAMPLE	PCIM	34W13	F	93	0	0	A1	/AA	

STEP 1 - BASIC SERIES

PCIM - PCIM Series

STEP 2 - CONNECTOR VARIANTS

- 30W15 - 15 size 16 contacts and 15 size 22 contacts
- 30W15R - 15 size 16 contacts and 15 size 22 contacts. Inverted termination style, use with contact type "4"
- 33W18 - 18 size 16 contacts and 15 size 22 contacts
- 33W18R - 18 size 16 contacts and 15 size 22 contacts. Inverted termination style, use with contact type "4"
- 34W13 - 13 size 16 contacts and 21 size 22 contacts
- 34W13R - 13 size 16 contacts and 21 size 22 contacts. Inverted termination style, use with contact type "4"
- 37W16 - 16 size 16 contacts and 21 size 22 contacts
- 37W16R - 16 size 16 contacts and 21 size 22 contacts. Inverted termination style, use with contact type "4"

STEP 3 - CONNECTOR GENDER

- F - Female
- M - Male

STEP 4 - CONTACT TERMINATION TYPE

- 3 - Solder, Straight Printed Board Mount with 4.50 [0.177] tail extension for connection system 1.
- 4 - Solder, Right Angle (90°) Printed Board Mount with 2.68 [0.106] tail extension for connection systems 1 and 4.
- 8 - Contacts must be ordered separately for Panel Mount Cable Connectors, connection system 3, see pages 102-103. Female connector only.
- 93 - Press-Fit, Compliant Termination size 16 and size 22 Straight Printed Board Mount for use with board thicknesses of 2.29 to 4.45 [0.090 to 0.175]. Connection system 1.
- 94 - Press-Fit, Compliant Termination size 16 and size 22 Straight Printed Board Mount for use with board thickness of 4.45 minimum [0.175 minimum]. Connection system 1.

STEP 9 - SPECIAL OPTIONS

FOR LISTING OF SPECIAL OPTIONS, SEE SPECIAL OPTIONS APPENDIX ON PAGES 107-108.

STEP 8 - ENVIRONMENTAL COMPLIANCE OPTIONS

/AA - Compliant per EU Directive 2002/95/EC (RoHS)

NOTE: If compliance to environmental legislation is not required, this step will not be used. Example: PCIM34W13F9300A1

STEP 7 - CONTACT PLATING FOR PRINTED BOARD TYPE CONNECTORS

- 0 - Crimp contacts ordered separately
- A1 - Gold flash over nickel on mating end and termination end.
- A2 - Gold flash over nickel on mating end and 5.00µ [0.00020 inch] tin-lead solder coat on termination end. Not available with code 93 or code 94 in step 4.
- C1 - 0.76µ [0.000030 inch] gold over nickel on mating end and termination end.
- C2 - 0.76µ [0.000030 inch] gold over nickel on mating end and 5.00µ [0.00020 inch] tin-lead solder coat on termination end. Not available with code 93 or code 94 in step 4.
- D1 - 1.27µ [0.000050 inch] gold over nickel on mating end and termination end.
- D2 - 11.27µ [0.000050 inch] gold over nickel on mating end and 5.00µ [0.00020 inch] tin-lead solder coat on termination end. Not available with code 93 or code 94 in step 4.

STEP 6 - HOODS

- 0 - Not applicable

STEP 5 - MOUNTING STYLE

- 0 - Standard Option
- See page 105 for mounting screw options.

NOTE: If you would like a 2D drawing or 3D model, once you've made your connector selection, please visit www.connectpositronic.com. If you can't find your specific part number on our web site, contact Technical Sales to have one created.

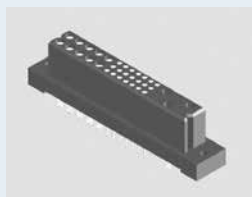
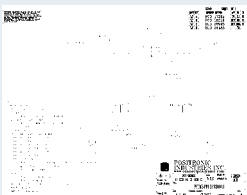



The PCIB Series encompasses all of the features of the PCIH Series in a smaller package. Reliability, high current capacity and many system management connections make the PCIB Series ideal for use in telecom, computer, information systems and industrial applications.

PCIB SERIES CONTACT VARIANTS

FACE VIEW OF MALE AND REAR VIEW OF FEMALE

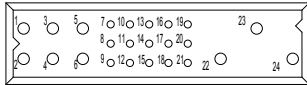

PCIB24W9 VARIANT

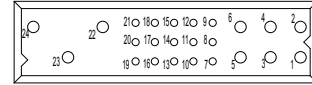

PCIB24W9R VARIANT (Inverted Termination)

9 Size 16 Power Contacts and 15 Size 22 Signal Contacts

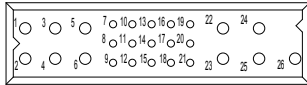

PCIB26W11 VARIANT

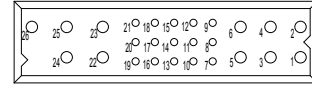

PCIB26W11R VARIANT (Inverted Termination)

11 Size 16 Power Contacts and 15 Size 22 Signal Contacts





MATERIALS AND FINISHES:

Insulator:	Glass-filled polyester, UL 94V-0, blue color.
Contacts:	Size 16 contacts: High conductivity precision-machined copper alloy. Size 22 contacts: Precision-machined copper alloy.
Plating:	Gold flash over nickel. Other plating options available, refer to Step 7 on page 89.
Mounting Screws:	Steel, zinc plated.
Jackscrews:	Stainless steel, passivated.

ELECTRICAL CHARACTERISTICS:

PCIB Contact Current Ratings, per UL 1977

See Temperature Rise Curves on page 5 for details.

PCIB24W9:

Size 16 Power Contacts: Positions 22, 23, and 24:	45 amperes continuous, all contacts under load.
Positions 1 through 6:	35 amperes continuous, all contacts under load.
Size 22 Signal Contacts:	3 amperes nominal rating.

PCIB26W11:

Size 16 Power Contacts:	34 amperes continuous, all contacts under load.
Size 22 Signal Contacts:	3 amperes nominal rating.

Initial Contact Resistance:

Size 16 Contact:	0.0007 ohms maximum.
Size 22 Contact:	0.004 ohms maximum. Per IEC 512-2, Test 2b.

Insulator Resistance:	5 G ohms per IEC 512-2, Test 3a.
------------------------------	----------------------------------

Voltage Proof:

PCIB24W9:

Contacts 22, 23 and 24:	3,000 V r.m.s.
Contacts 1 through 6:	1,500 V r.m.s.
Contacts 7 through 21:	1,000 V r.m.s.

PCIB26W11:

Contacts 1 through 6 and 22 through 26:	1,500 V r.m.s.
Contacts 7 through 21:	1,000 V r.m.s.

Creepage and Clearance

Distance; minimum:

PCIB24W9:

Contact 24 to Contact 22:	3.2mm [0.126 inch]
Contact 23 to Contact 22:	3.2mm [0.126 inch]
Contact 24 to Signal Contacts:	6.4mm [0.252 inch]
Contact 23 to Signal Contacts:	6.4mm [0.252 inch]
Contact 24 to Contact 23:	2.5mm [0.098 inch]
Contact 22 to Signal Contacts:	2.0mm [0.079 inch]

PCIB26W11:

Contact 22 to Signal Contacts:	2.0mm [0.079 inch]
--------------------------------	--------------------

Working Voltage:

PCIB24W9:

Contacts 22, 23 and 24:	1,000 V r.m.s.
Contacts 1 through 6:	500 V r.m.s.
Contacts 7 through 21:	333 V r.m.s.

PCIB26W11:

Contacts 1 through 6 and 22 through 26:	500 V r.m.s.
Contacts 7 through 21:	333 V r.m.s.

MECHANICAL CHARACTERISTICS:

Blind Mating System:	Male and female connector bodies provide "lead-in" for 1.3 mm [0.050 inch] diametral misalignment.
Polarization:	Provided by connector body design.

Removable Contacts:	Install contact from rear of insulator; release from front of insulator. Size 16 and 22 female contacts feature "Closed Entry" design for highest reliability.
----------------------------	--

Removable Contact Retention in Connector Body:

Size 16 Contacts:	67 N [15 lbs.]
Size 22 Contacts:	27 N [6 lbs.]

Fixed Contacts:	Printed board terminations, both straight and right angle (90°). Size 16 female contacts feature "Closed Entry" design. Size 22 feature rugged "Open Entry" contact design. "Closed Entry" contacts available, consult Technical Sales.
------------------------	---

Fixed Contact Retention in Connector Body:

Size 16 Contacts:	45 N [10 lbs.]
Size 22 Contacts:	27 N [6 lbs.]

Resistance to Solder Heat:	260°C [500°F] for 10 seconds duration per IEC 512-6, Test 12e, 25-watt soldering iron.
-----------------------------------	--

Sequential Contact Mating System:

PCIB24W9:	First mate contact 22 and last mate contact position 7.
PCIB26W11:	Last mate contact position 7.

Consult Technical Sales for customer specified sequential mating.

Safety "Recessed in Insulator" Contacts:

The following size 16 contacts are recessed 5.00 mm [0.197 inch] below the face of the female connector insulator per safety requirements. Contact positions 23 and 24. None

**PCIB24W9:
PCIB26W11:**

Compliant Terminations:	Size 16 and 22 contacts are available with compliant contact terminations. Average insertion and extraction forces of size 16 contacts are 22N (5 lbs.) per contact.
--------------------------------	--

Printed Board Mounting:	Mounting holes provided in connector body for printed board mounting. Self-tapping screws are available.
--------------------------------	--

Mechanical Operations:	250 couplings, minimum.
-------------------------------	-------------------------

CLIMATIC CHARACTERISTICS:

Working Temperature:	-55°C to +125°C.
-----------------------------	------------------

**U.L. Recognized File #E49351
CSA Recognized File #LR54219**

**DIMENSIONS ARE IN MILLIMETERS [INCHES].
ALL DIMENSIONS ARE SUBJECT TO CHANGE.**



PCIB CONNECTOR OUTLINE DIMENSIONS

RIGHT ANGLE (90°) BOARD MOUNT CONNECTOR

FEMALE CONNECTOR

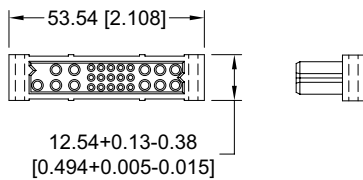
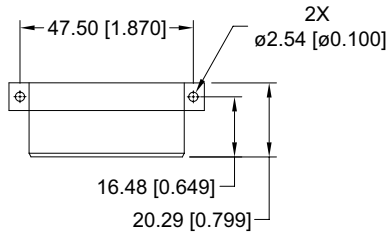

MALE CONNECTOR

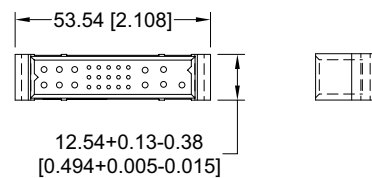
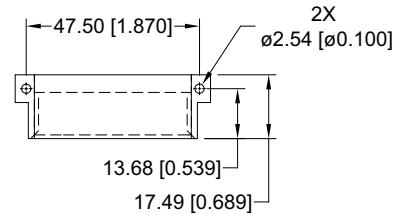

STRAIGHT BOARD MOUNT CONNECTOR

FEMALE CONNECTOR

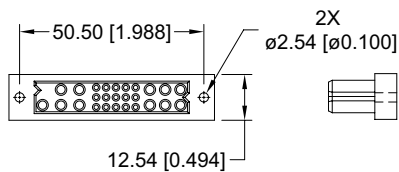
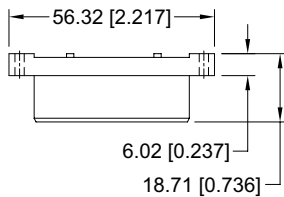

MALE CONNECTOR

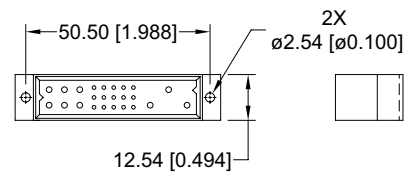
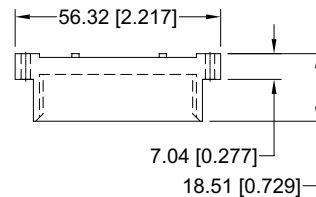

PCIB CONNECTOR MATING DIMENSIONS (FULLY MATED)

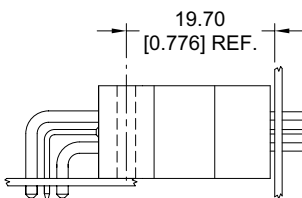

Right Angle (90°) Board
Mount Male to Straight
Board Mount or Panel
Mount Female

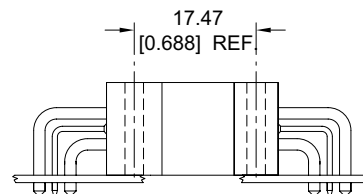

Right Angle (90°)
Board Mount Male to
Right Angle (90°)
Board Mount Female

FEMALE STRAIGHT SOLDER CONNECTOR CODE 3

STANDARD PART NUMBER
PCIB24W9F300A1

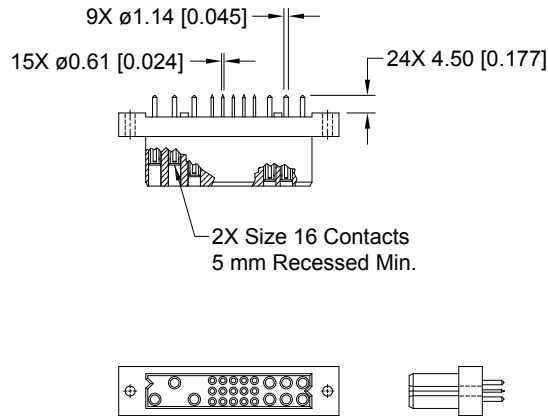

CONNECTOR DIMENSIONS

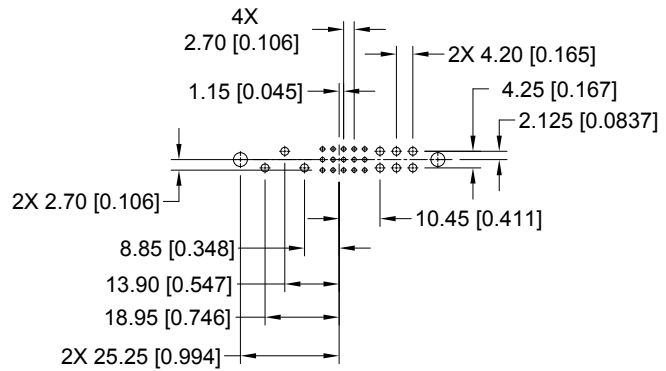

CONTACT HOLE PATTERN

Note: See below for suggested printed board hole sizes.

FEMALE STRAIGHT SOLDER CONNECTOR WITH A.C. PASS-THROUGH CODE 3 WITH MOS* -246.5

CRIMP CONTACTS ARE NOT SUPPLIED WITH CONNECTOR AND MUST BE ORDERED SEPARATELY

LOW PROFILE PART NUMBER
PCIB24W9F300A1-246.5

* For MOS descriptions,
see chart on pages 107-108.

Crimp contacts
ordered separately
(see pages 102-103)

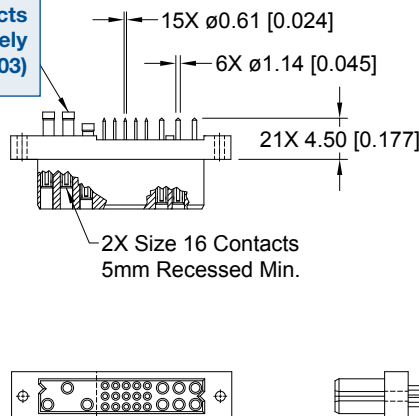

CONNECTOR DIMENSIONS

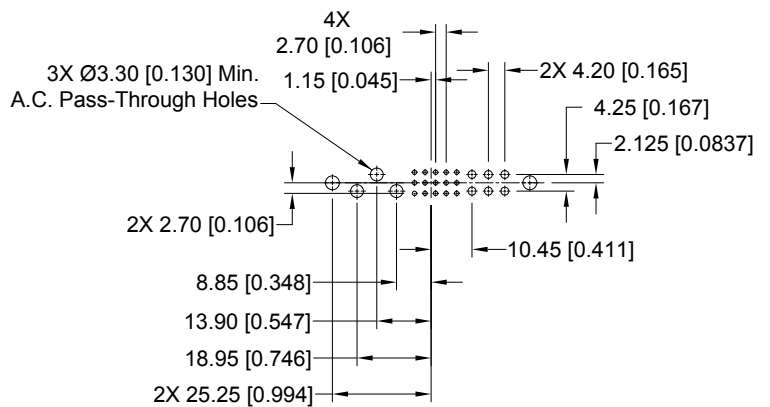

CONTACT HOLE PATTERN

SUGGESTED PRINTED BOARD HOLE SIZES:

Suggest $\text{Ø}1.00$ [0.039] holes for size 22 contact holes.
Suggest $\text{Ø}1.60$ [0.063] holes for size 16 contact holes.
Suggest $\text{Ø}3.56\pm 0.08$ [0.140 \pm 0.003] holes for connector mounting holes.

DIMENSIONS ARE IN MILLIMETERS [INCHES].
ALL DIMENSIONS ARE SUBJECT TO CHANGE.



STRAIGHT SOLDER CONNECTOR, FEMALE

FEMALE STRAIGHT SOLDER CONNECTOR CODE 3

STANDARD PART NUMBER
PCIB26W11F300A1

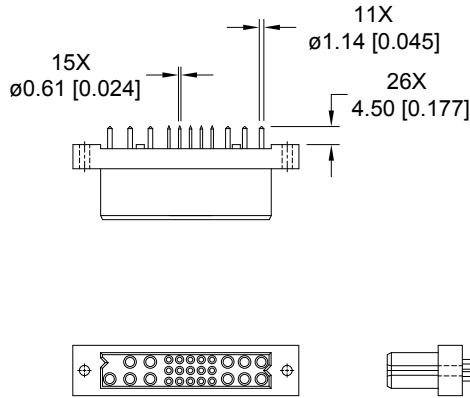

CONNECTOR DIMENSIONS

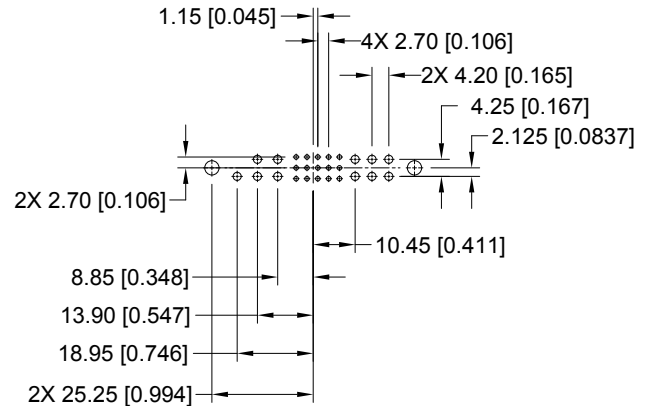

CONTACT HOLE PATTERN

Note: See below for suggested printed board hole sizes.

FEMALE STRAIGHT SOLDER CONNECTOR WITH A.C. PASS-THROUGH CODE 3 WITH MOS* -246.6

CRIMP CONTACTS ARE NOT SUPPLIED WITH CONNECTOR AND MUST BE ORDERED SEPARATELY

LOW PROFILE PART NUMBER
PCIB26W11F300A1-246.6

* For MOS descriptions,
see chart on pages 107-108.

Crimp contacts
ordered separately
(see pages 102-103)

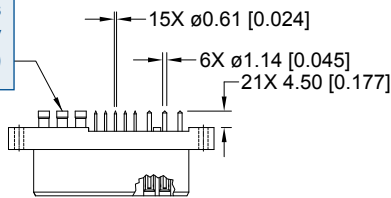

CONNECTOR DIMENSIONS

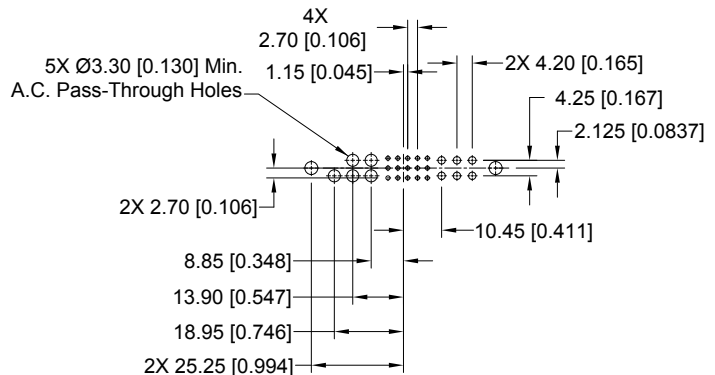

CONTACT HOLE PATTERN

SUGGESTED PRINTED BOARD HOLE SIZES:

Suggest $\varnothing 1.00$ [0.039] holes for size 22 contact holes.

Suggest $\varnothing 1.60$ [0.063] holes for size 16 contact holes.

Suggest $\varnothing 3.56 \pm 0.08$ [0.140 \pm 0.003] holes for connector mounting holes.

**MALE STRAIGHT SOLDER CONNECTOR
CODE 3**

**STANDARD PART NUMBER
PCIB24W9M300A1**

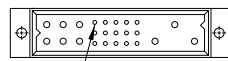
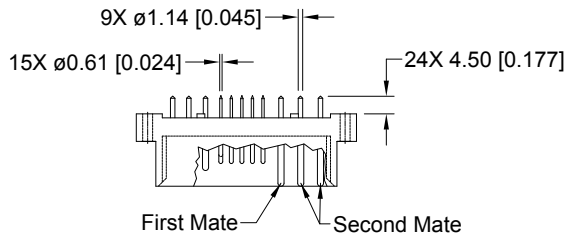

Position 7
Last to
Mate Signal

CONNECTOR DIMENSIONS

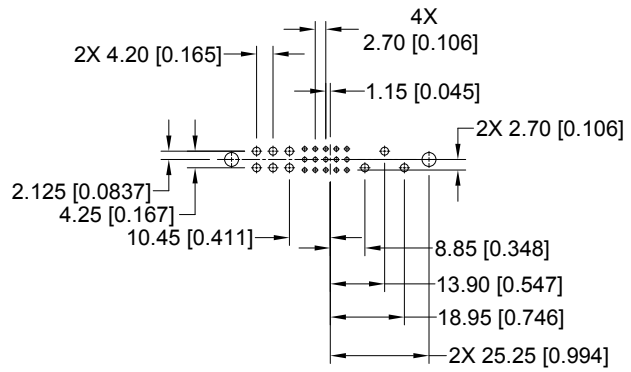

CONTACT HOLE PATTERN

Note: See below for suggested printed board hole sizes.

**MALE STRAIGHT SOLDER CONNECTOR
CODE 3**

**STANDARD PART NUMBER
PCIB26W11M300A1**

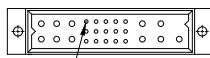
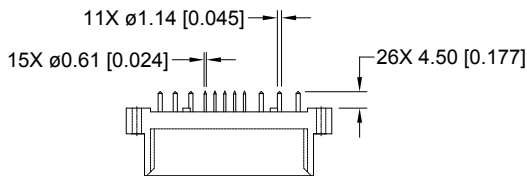

Position 7
Last to
Mate Signal

CONNECTOR DIMENSIONS

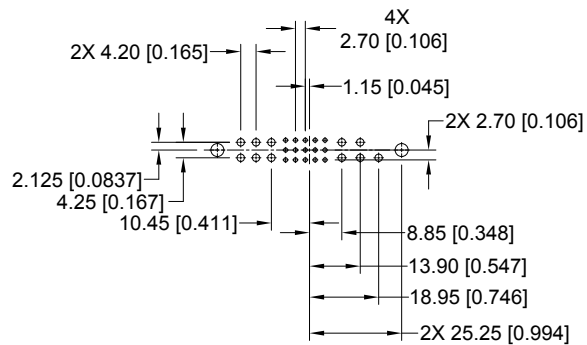

CONTACT HOLE PATTERN

SUGGESTED PRINTED BOARD HOLE SIZES:

Suggest $\varnothing 1.14$ [0.045] holes for size 22 contact holes.
Suggest $\varnothing 2.03$ [0.080] holes for size 16 contact holes.
Suggest $\varnothing 3.56 \pm 0.08$ [0.140 \pm 0.003] holes for connector mounting holes.

**DIMENSIONS ARE IN MILLIMETERS [INCHES].
ALL DIMENSIONS ARE SUBJECT TO CHANGE.**



Positronic
connectpositronic.com

STRAIGHT SOLDER CONNECTOR, MALE

Compact
Power
Connectors

MALE STRAIGHT SOLDER CONNECTOR WITH JACKSCREW SYSTEM CODE 3 WITH MOS* -444.0

OTHER JACKSCREW LENGTH OPTIONS AVAILABLE, CONTACT TECHNICAL SALES FOR DETAILS

STANDARD PART NUMBER
PCIB26W11M300A1-444.0

* For MOS descriptions,
see chart on pages 107-108.

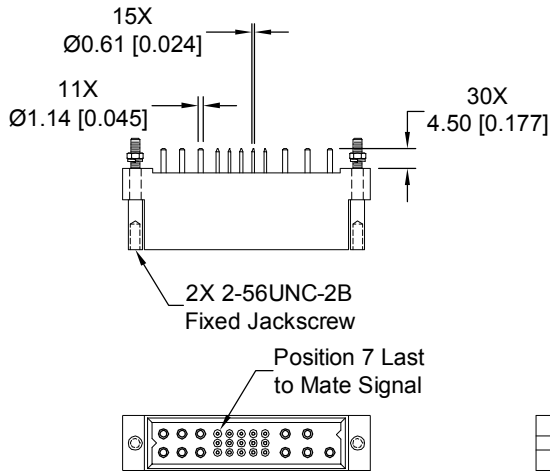

CONNECTOR DIMENSIONS

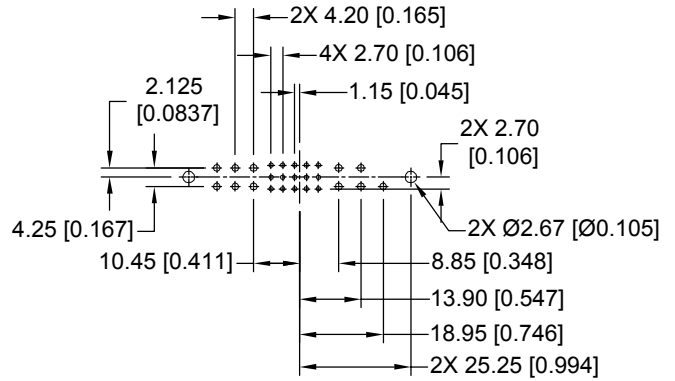

CONTACT HOLE PATTERN

SUGGESTED PRINTED BOARD HOLE SIZES:

Suggest Ø1.14 [0.045] holes for size 22 contact holes.

Suggest Ø2.03 [0.080] holes for size 16 contact holes.

Suggest Ø3.56±0.08 [0.140±0.003] holes for connector mounting holes.

**FEMALE RIGHT ANGLE (90°) BOARD MOUNT CONNECTOR
CODE 4**

**STANDARD PART NUMBER
PCIB24W9F400A1**

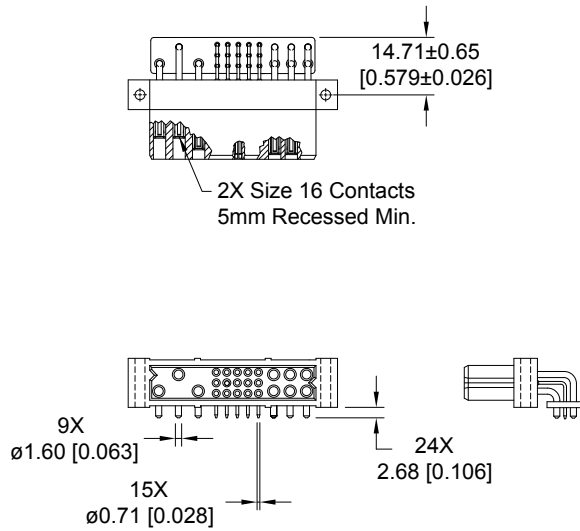

CONNECTOR DIMENSIONS

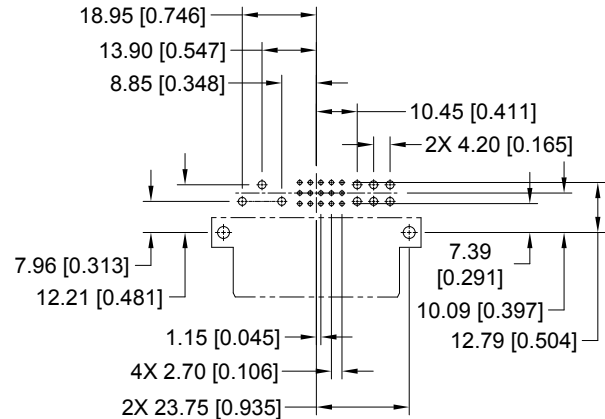

CONTACT HOLE PATTERN

Note: See below for suggested printed board hole sizes.

**FEMALE RIGHT ANGLE (90°) BOARD MOUNT CONNECTOR
CODE 4**

**PART NUMBER FOR INVERTED TERMINATION
PCIB24W9RF400A1**

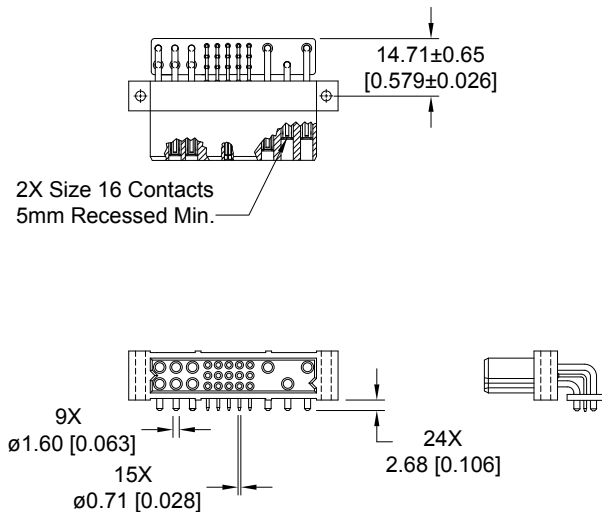

CONNECTOR DIMENSIONS

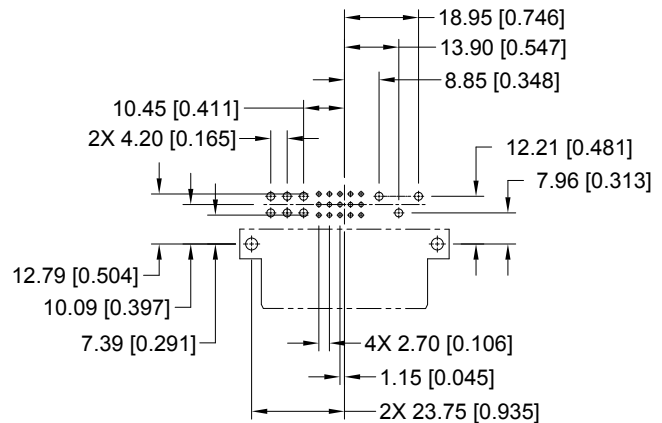

CONTACT HOLE PATTERN

SUGGESTED PRINTED BOARD HOLE SIZES:

- Suggest Ø1.14 [0.045] holes for size 22 contact holes.
- Suggest Ø2.03 [0.080] holes for size 16 contact holes.
- Suggest Ø3.56±0.08 [0.140±0.003] holes for connector mounting holes.

**DIMENSIONS ARE IN MILLIMETERS [INCHES].
ALL DIMENSIONS ARE SUBJECT TO CHANGE.**



Positronic
connectpositronic.com

RIGHT ANGLE (90°) BOARD MOUNT CONNECTOR, FEMALE

Compact
Power
Connectors

FEMALE RIGHT ANGLE (90°) BOARD MOUNT CONNECTOR WITH A.C. PASS-THROUGH CODE 4 WITH MOS* -422.0

CRIMP CONTACTS ARE NOT SUPPLIED WITH CONNECTOR AND MUST BE ORDERED SEPARATELY

LOW PROFILE PART NUMBER
PCIB24W9F400A1-422.0

Crimp contacts
ordered separately
(see pages 102-103)

* For MOS descriptions,
see chart on pages 107-108.

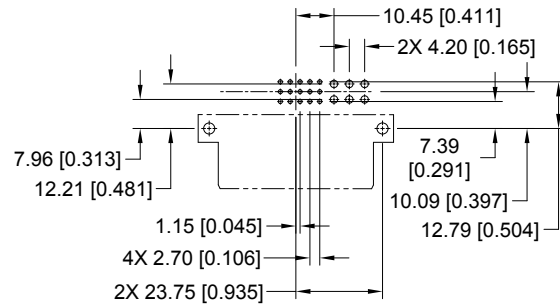
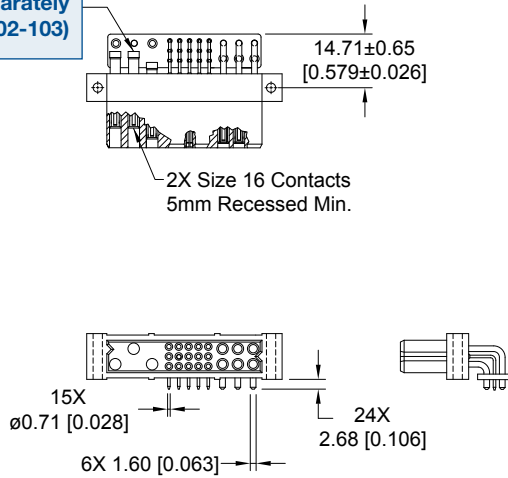

CONTACT HOLE PATTERN

CONNECTOR DIMENSIONS

SUGGESTED PRINTED BOARD HOLE SIZES:

- Suggest ∅1.14 [0.045] holes for size 22 contact holes.
- Suggest ∅2.03 [0.080] holes for size 16 contact holes.
- Suggest ∅3.56±0.08 [0.140±0.003] holes for connector mounting holes.

**FEMALE RIGHT ANGLE (90°) BOARD MOUNT CONNECTOR
CODE 4**

**STANDARD PART NUMBER
PCIB26W11F400A1**

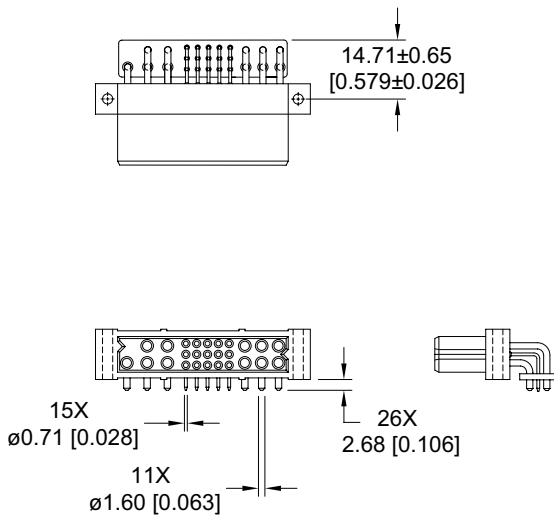

CONNECTOR DIMENSIONS

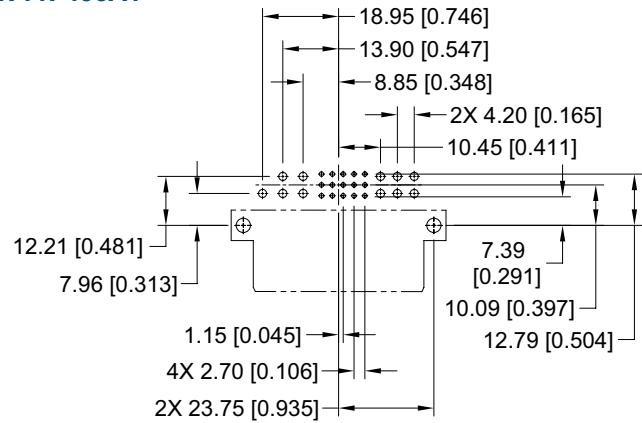

CONTACT HOLE PATTERN

Note: See below for suggested printed board hole sizes.

**FEMALE RIGHT ANGLE (90°) BOARD MOUNT CONNECTOR
CODE 4**

**PART NUMBER FOR INVERTED TERMINATION
PCIB26W11RF400A1**

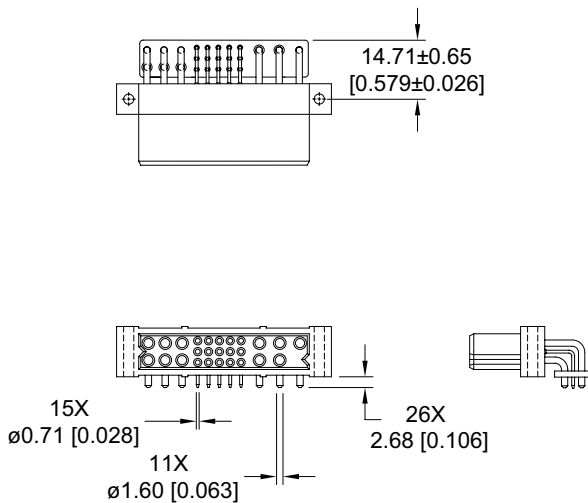

CONNECTOR DIMENSIONS

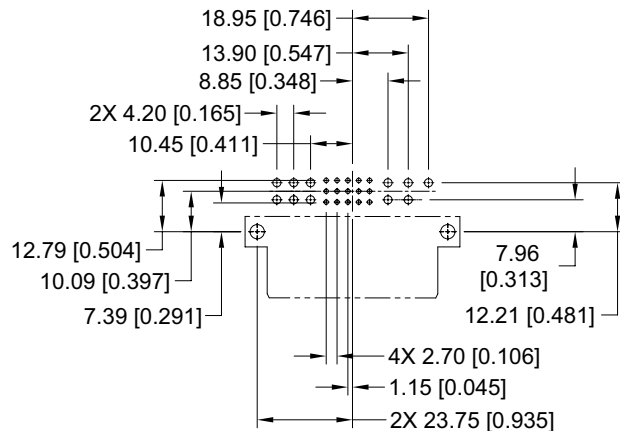

CONTACT HOLE PATTERN

SUGGESTED PRINTED BOARD HOLE SIZES:

- Suggest Ø1.14 [0.045] holes for size 22 contact holes.
- Suggest Ø2.03 [0.080] holes for size 16 contact holes.
- Suggest Ø3.56±0.08 [0.140±0.003] holes for connector mounting holes.

**DIMENSIONS ARE IN MILLIMETERS [INCHES].
ALL DIMENSIONS ARE SUBJECT TO CHANGE.**



MALE RIGHT ANGLE (90°) BOARD MOUNT CONNECTOR CODE 4

STANDARD PART NUMBER
PCIB24W9M400A1

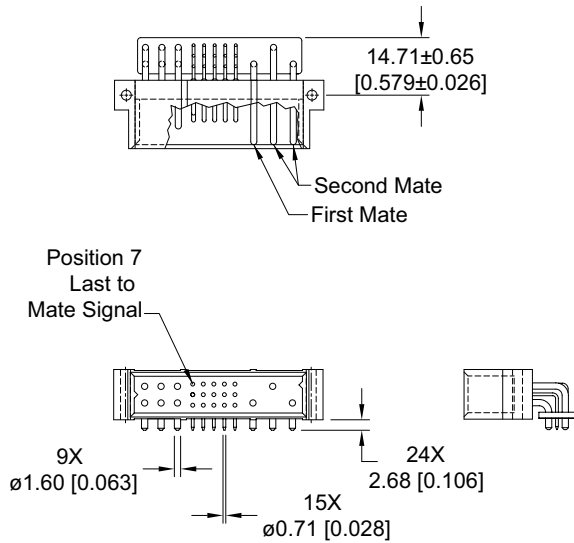

CONNECTOR DIMENSIONS

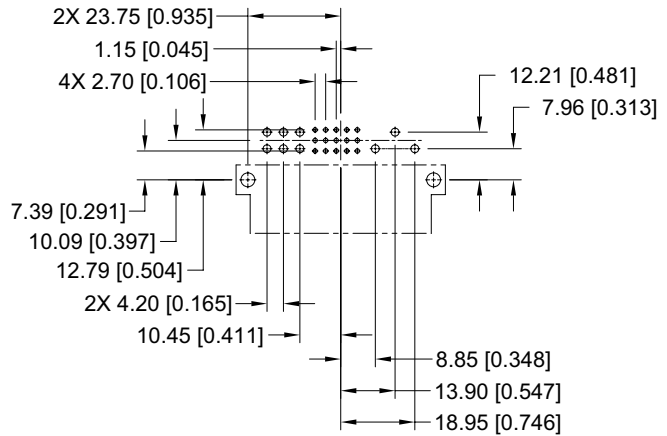

CONTACT HOLE PATTERN

Note: See below for suggested printed board hole sizes.

MALE RIGHT ANGLE (90°) BOARD MOUNT CONNECTOR CODE 4

PART NUMBER FOR INVERTED TERMINATION
PCIB24W9RM400A1

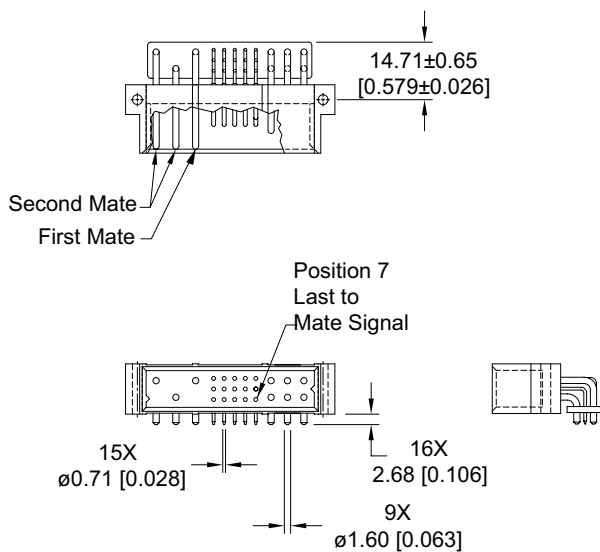

CONNECTOR DIMENSIONS

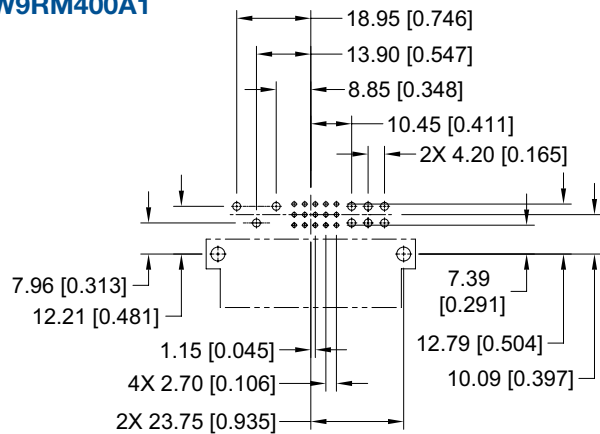

CONTACT HOLE PATTERN

SUGGESTED PRINTED BOARD HOLE SIZES:

Suggest $\varnothing 1.14$ [0.045] holes for size 22 contact holes.

Suggest $\varnothing 2.03$ [0.080] holes for size 16 contact holes.

Suggest $\varnothing 3.56 \pm 0.08$ [0.140 ± 0.003] holes for connector mounting holes.

MALE RIGHT ANGLE (90°) BOARD MOUNT CONNECTOR
CODE 4

STANDARD PART NUMBER
PCIB26W11M400A1

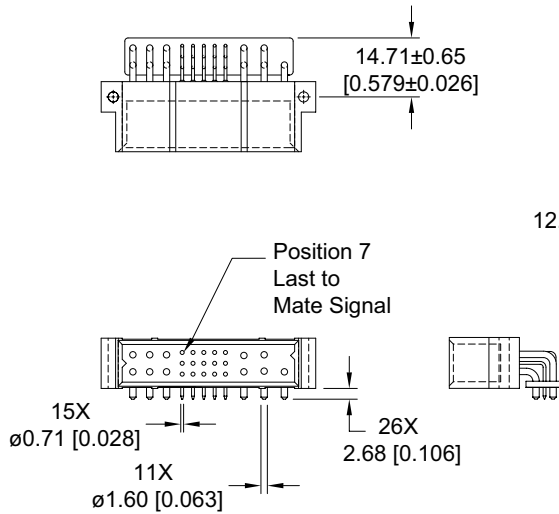

CONNECTOR DIMENSIONS

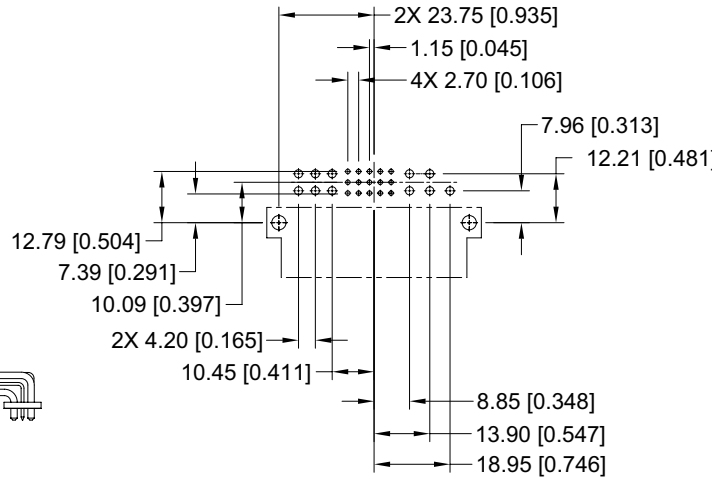

CONTACT HOLE PATTERN

Note: See below for suggested printed board hole sizes.

MALE RIGHT ANGLE (90°) BOARD MOUNT CONNECTOR
CODE 4

PART NUMBER FOR INVERTED TERMINATION
PCIB26W11RM400A1

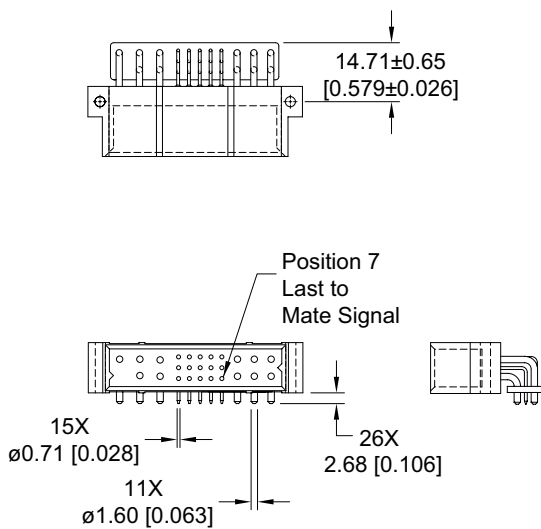

CONNECTOR DIMENSIONS

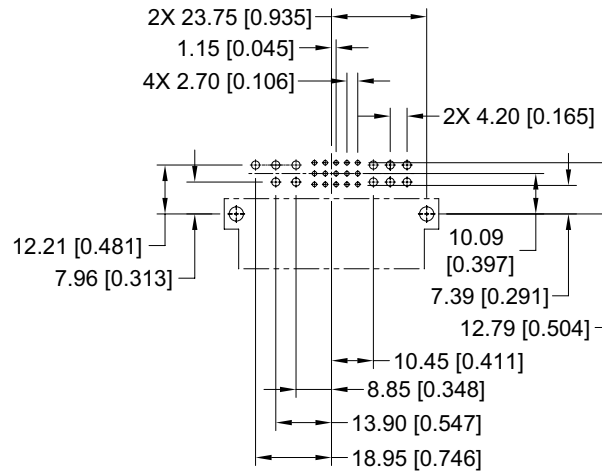

CONTACT HOLE PATTERN

SUGGESTED PRINTED BOARD HOLE SIZES:

- Suggest Ø1.14 [0.045] holes for size 22 contact holes.
- Suggest Ø2.03 [0.080] holes for size 16 contact holes.
- Suggest Ø3.56±0.08 [0.140±0.003] holes for connector mounting holes.

DIMENSIONS ARE IN MILLIMETERS [INCHES].
ALL DIMENSIONS ARE SUBJECT TO CHANGE.



FEMALE PANEL MOUNT CRIMP CONTACT CONNECTOR CODE 8

CONTACTS ARE NOT SUPPLIED WITH CONNECTOR AND MUST BE ORDERED SEPARATELY

STANDARD PART NUMBER

PCIB24W9F8000

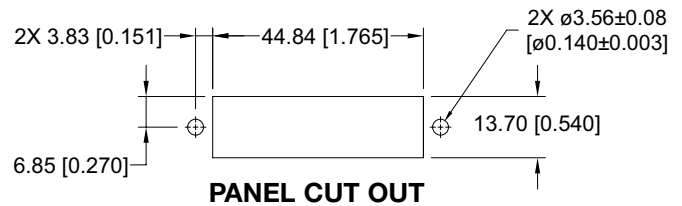
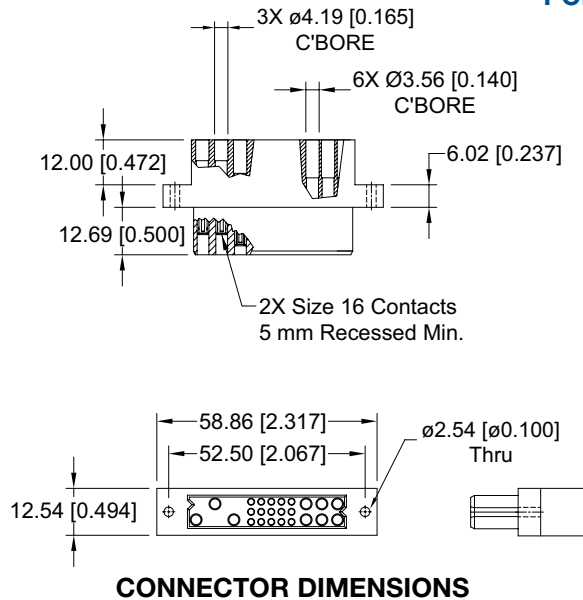

FEMALE PANEL MOUNT CRIMP CONTACT CONNECTOR CODE 8

CONTACTS ARE NOT SUPPLIED WITH CONNECTOR AND MUST BE ORDERED SEPARATELY

STANDARD PART NUMBER

PCIB26W11F8000

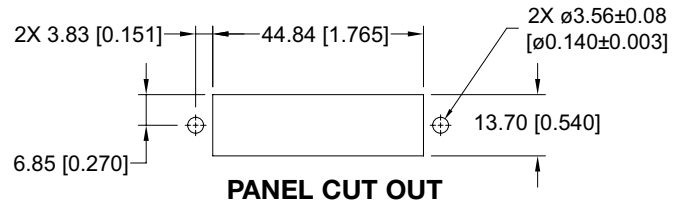
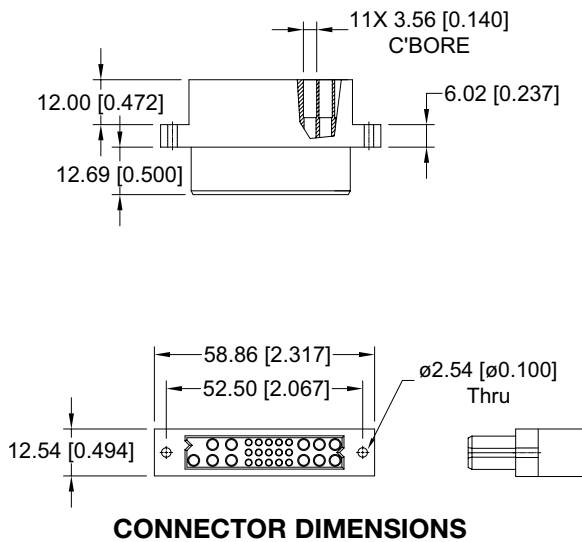

For information regarding removable contacts, see Removable Contact section, pages 102-103.

**FEMALE PANEL MOUNT CRIMP CONTACT CONNECTOR WITH JACKSCREW SYSTEM
CODE 8 WITH MOS* -443.0**

CONTACTS ARE NOT SUPPLIED WITH CONNECTOR AND MUST BE ORDERED SEPARATELY

**STANDARD PART NUMBER
PCIB26W11F8000-443.0**

* For MOS descriptions,
see chart on pages 107-108.

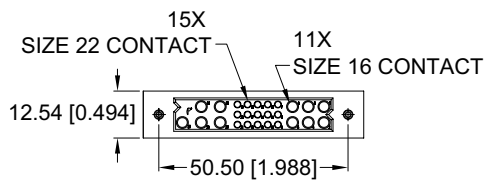
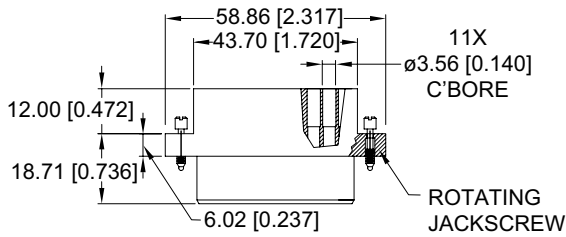

CONNECTOR DIMENSIONS

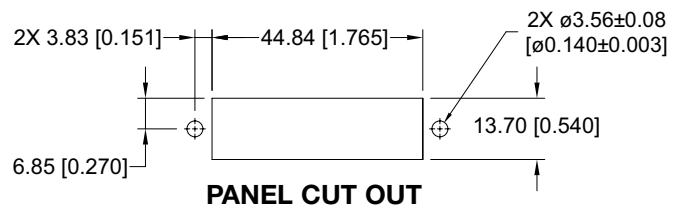

PANEL CUT OUT

For information regarding removable contacts, see Removable Contact section, pages 102-103.



COMPLIANT PRESS-FIT BOARD MOUNT CONNECTOR, FEMALE

FEMALE COMPLIANT PRESS-FIT CONNECTORS CODE 93 or 94

STANDARD PART NUMBER
PCIB24W9F9300A1
PCIB24W9F9400A1

Positronic recommends the practice of using mounting hardware to secure connector to printed circuit board.

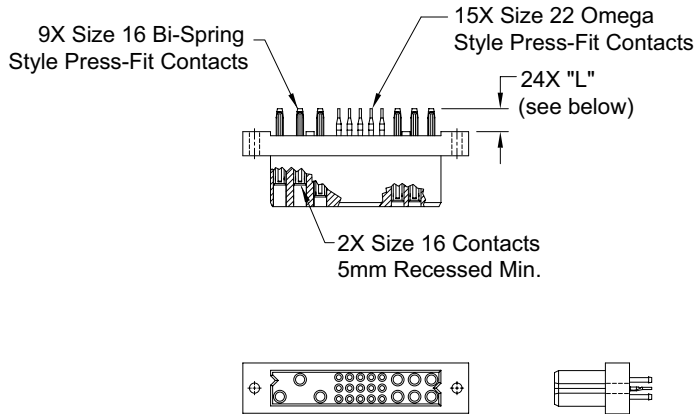

CONNECTOR DIMENSIONS

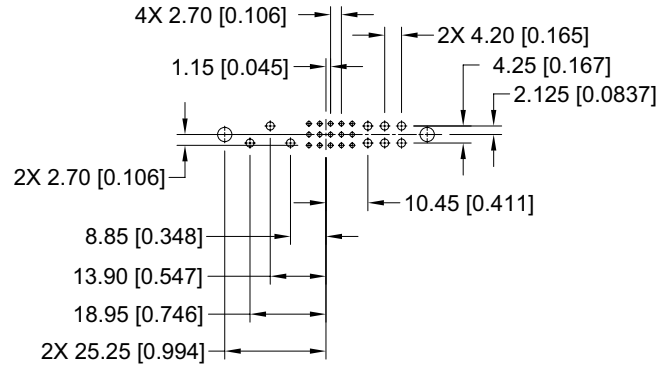

CONTACT HOLE PATTERN

CONTACT TAIL LENGTH		
Code	"L" Length	Board Thickness
93	5.72 [0.225]	2.29 to 4.45 [0.090 to 0.175]
94	7.04 [0.277]	4.45 min. [0.175 min.]

Note: See below for suggested printed board hole sizes, press-fit connector installation tools, and mounting screw options.

FEMALE COMPLIANT PRESS-FIT CONNECTORS WITH A.C. PASS-THROUGH CODE 93 OR 94 WITH MOS* -246.5

CRIMP CONTACTS ARE NOT SUPPLIED WITH CONNECTOR AND MUST BE ORDERED SEPARATELY

* For MOS descriptions, see chart on pages 107-108.

LOW PROFILE PART NUMBER
PCIB24W9F9300A1-246.5
PCIB24W9F9400A1-246.5

Positronic recommends the practice of using mounting hardware to secure connector to printed circuit board.

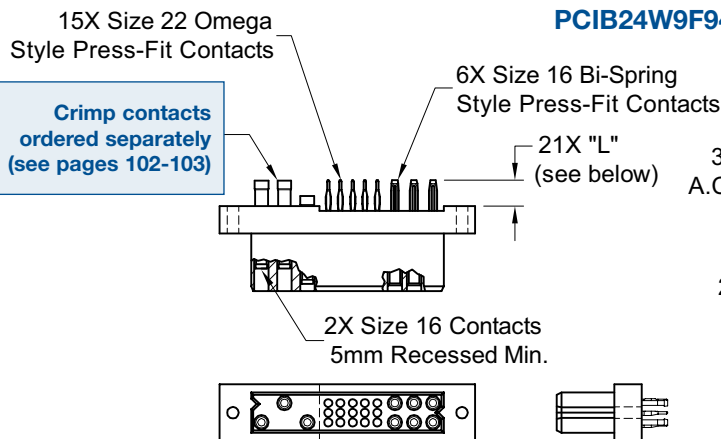

CONNECTOR DIMENSIONS

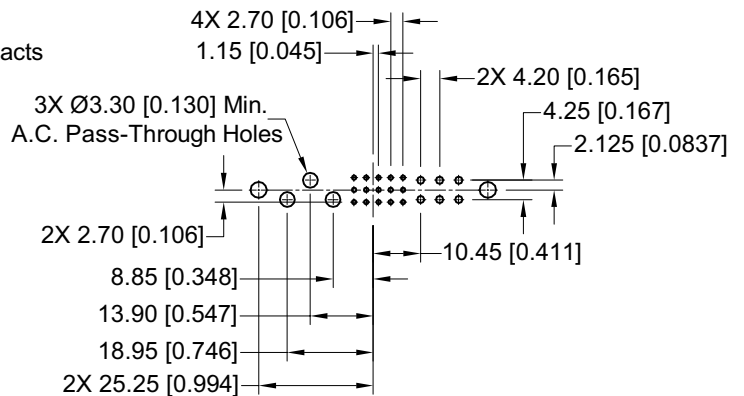

CONTACT HOLE PATTERN

CONTACT TAIL LENGTH		
Code	"L" Length	Board Thickness
93	5.72 [0.225]	2.29 to 4.45 [0.090 to 0.175]
94	7.04 [0.277]	4.45 min. [0.175 min.]

SUGGESTED PRINTED BOARD HOLE SIZES:

Suggest $\text{Ø}3.56\pm0.08$ [0.140±0.003] holes for connector mounting holes.

NOTE: See page 105 for suggested printed board drill hole sizes, recommended plating and finished hole sizes for compliant contact termination positions.

For press-fit connector installation tools, see pages 105-106.

For mounting screw options, see page 105.



FEMALE COMPLIANT PRESS-FIT CONNECTOR CODE 93 or 94

STANDARD PART NUMBER
PCIB26W11F9300A1
PCIB26W11F9400A1

Positronic recommends the practice of using mounting hardware to secure connector to printed circuit board.

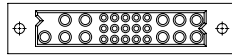
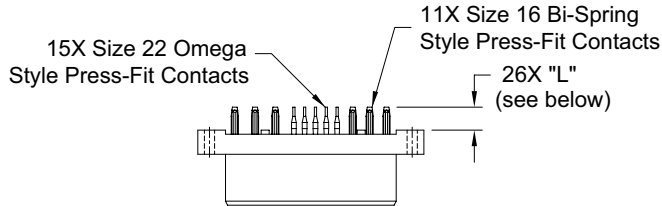

CONNECTOR DIMENSIONS

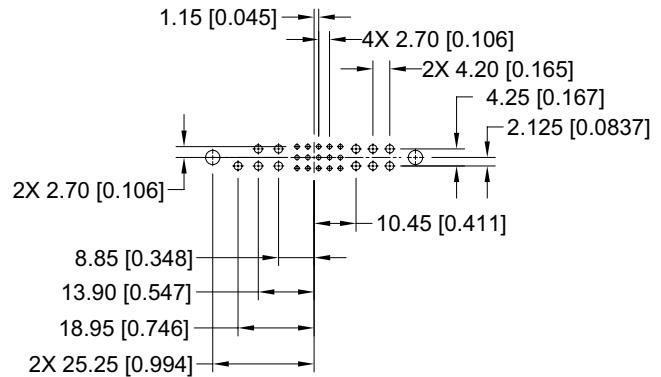

CONTACT HOLE PATTERN

CONTACT TAIL LENGTH		
Code	"L" Length	Board Thickness
93	5.72 [0.225]	2.29 to 4.45 [0.090 to 0.175]
94	7.04 [0.277]	4.45 min. [0.175 min.]

Note: See below for suggested printed board hole sizes, press-fit connector installation tools, and mounting screw options.

FEMALE COMPLIANT PRESS-FIT CONNECTOR WITH A.C. PASS-THROUGH CODE 93 or 94 WITH MOS* -246.6

CRIMP CONTACTS ARE NOT SUPPLIED WITH CONNECTOR AND MUST BE ORDERED SEPARATELY

* For MOS descriptions, see chart on pages 107-108.

LOW PROFILE PART NUMBER
PCIB26W11F9300A1-246.6
PCIB26W11F9400A1-246.6

Positronic recommends the practice of using mounting hardware to secure connector to printed circuit board.

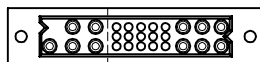
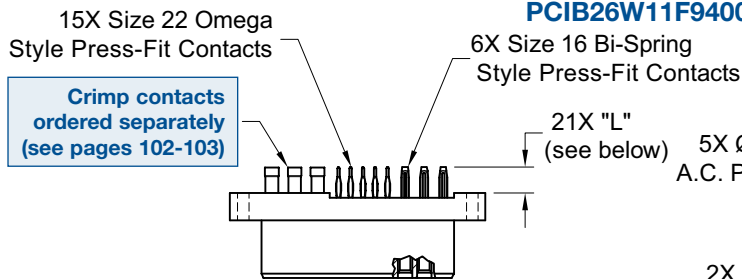

CONNECTOR DIMENSIONS

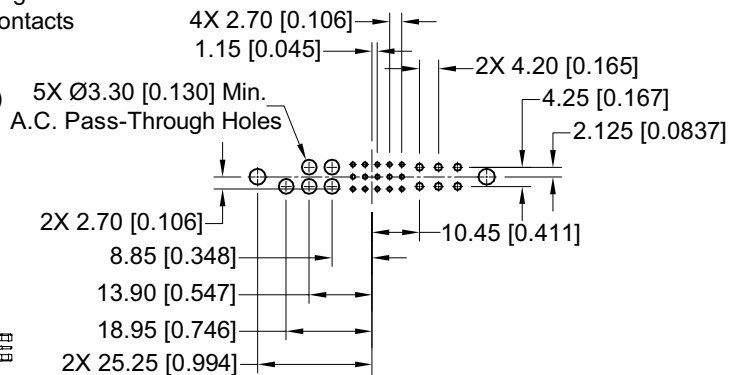

CONTACT HOLE PATTERN

SUGGESTED PRINTED BOARD HOLE SIZES:

Suggest $\varnothing 3.56 \pm 0.08$ [0.140 ± 0.003] holes for connector mounting holes.

NOTE: See page 105 for suggested printed board drill hole sizes, recommended plating and finished hole sizes for compliant contact termination positions.

For press-fit connector installation tools, see pages 105-106.

For mounting screw options, see page 105.

CONTACT TAIL LENGTH		
Code	"L" Length	Board Thickness
93	5.72 [0.225]	2.29 to 4.45 [0.090 to 0.175]
94	7.04 [0.277]	4.45 min. [0.175 min.]

DIMENSIONS ARE IN MILLIMETERS [INCHES].
ALL DIMENSIONS ARE SUBJECT TO CHANGE.



COMPLIANT PRESS-FIT BOARD MOUNT CONNECTOR, MALE

MALE COMPLIANT PRESS-FIT CONNECTOR CODE 93 or 94

STANDARD PART NUMBER
PCIB24W9M9300A1
PCIB24W9M9400A1

Positronic recommends the practice of using mounting hardware to secure connector to printed circuit board.

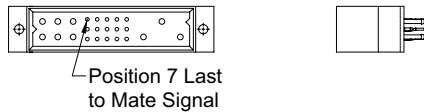
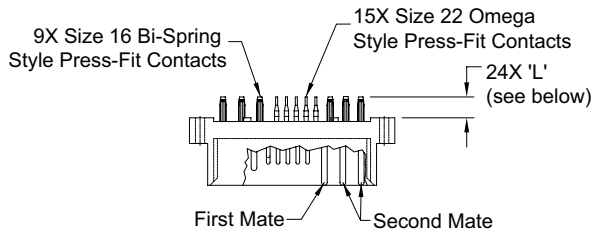

CONNECTOR DIMENSIONS

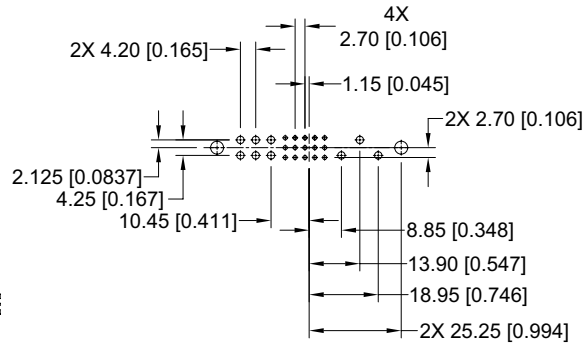

CONTACT HOLE PATTERN

Note: See below for suggested printed board hole sizes, press-fit connector installation tools, and mounting screw options.

CONTACT TAIL LENGTH		
Code	"L" Length	Board Thickness
93	5.72 [0.225]	2.29 to 4.45 [0.090 to 0.175]
94	7.04 [0.277]	4.45 min. [0.175 min.]

MALE COMPLIANT PRESS-FIT CONNECTOR CODE 93 or 94

STANDARD PART NUMBER
PCIB26W11M9300A1
PCIB26W11M9400A1

Positronic recommends the practice of using mounting hardware to secure connector to printed circuit board.

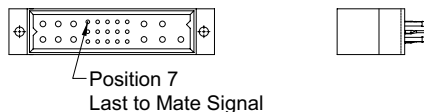
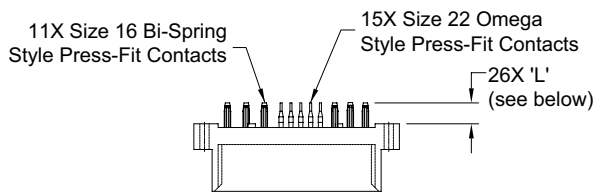

CONNECTOR DIMENSIONS

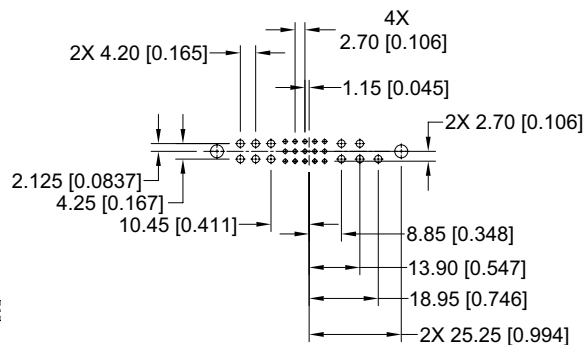

CONTACT HOLE PATTERN

CONTACT TAIL LENGTH		
Code	"L" Length	Board Thickness
93	5.72 [0.225]	2.29 to 4.45 [0.090 to 0.175]
94	7.04 [0.277]	4.45 min. [0.175 min.]

SUGGESTED PRINTED BOARD HOLE SIZES:

Suggest $\varnothing 3.56 \pm 0.08$ [0.140 \pm 0.003] holes for connector mounting holes.

NOTE: See page 105 for suggested printed board drill hole sizes, recommended plating and finished hole sizes for compliant contact termination positions.

For press-fit connector installation tools, see pages 105-106.

For mounting screw options, see page 105.



**MALE COMPLIANT PRESS-FIT CONNECTOR WITH JACKSCREW SYSTEM
CODE 93 OR 94 WITH MOS* -444.0**

OTHER JACKSCREW LENGTH OPTIONS AVAILABLE, CONTACT TECHNICAL SALES FOR DETAILS

STANDARD PART NUMBER
PCIB26W11M9300A1-444.0
PCIB26W11M9400A1-444.0

* For MOS descriptions,
see chart on pages 107-108.

Positronic recommends the practice
of using mounting hardware to secure
connector to printed circuit board.

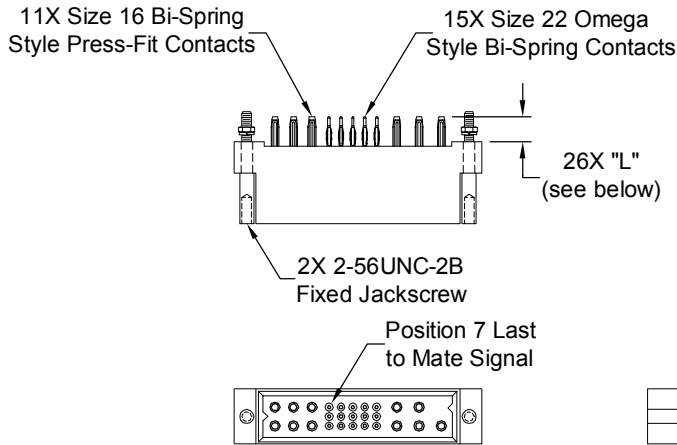

CONNECTOR DIMENSIONS

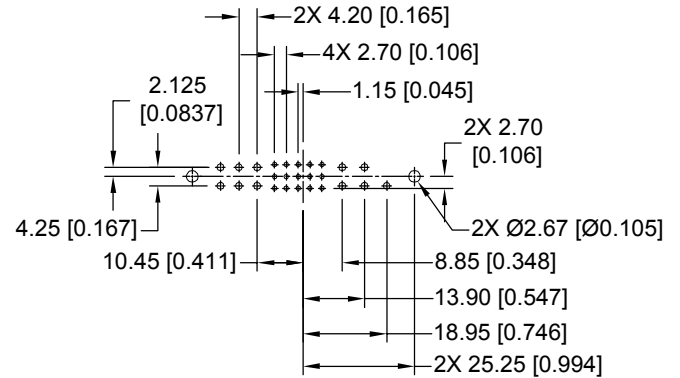

CONTACT HOLE PATTERN

SUGGESTED PRINTED BOARD HOLE SIZES:

Suggest $\text{Ø}3.56\pm0.08$ [0.140±0.003] holes for connector mounting holes.

NOTE: See page 105 for suggested printed board drill hole sizes, recommended plating and finished hole sizes for compliant contact termination positions.

For press-fit connector installation tools, see pages 105-106.

For mounting screw options, see page 105.

CONTACT TAIL LENGTH

Code	"L" Length	Board Thickness
93	5.72 [0.225]	2.29 to 4.45 [0.090 to 0.175]
94	7.04 [0.277]	4.45 min. [0.175 min.]



ORDERING INFORMATION - CODE NUMBERING SYSTEM

Specify Complete Connector By Selecting An Option From Step 1 Through 7

STEP	1	2	3	4	5	6	7	8	9
EXAMPLE	PCIB	26W11	F	93	0	0	A1	/AA	

STEP 1 - BASIC SERIES

PCIB - PCIB Series

STEP 2 - CONNECTOR VARIANTS

- 24W9 - 9 size 16 contacts and 15 size 22 contacts
- 24W9R - 9 size 16 contacts and 15 size 22 contacts. Inverted termination style, use with contact type "4"
- 26W11 - 11 size 16 contacts and 15 size 22 contacts
- 26W11R - 11 size 16 contacts and 15 size 22 contacts. Inverted termination style, use with contact type "4"

STEP 3 - CONNECTOR GENDER

- F - Female
- M - Male

STEP 4 - CONTACT TERMINATION TYPE

- 3 - Solder, Straight Printed Board Mount with 4.50 [0.177] tail extension for connection system 1.
- 4 - Solder, Right Angle (90°) Printed Board Mount with 2.68 [0.106] tail extension for connection systems 1 and 4.
- 8 - Contacts must be ordered separately for Panel Mount Cable Connectors, connection system 3, see pages 102-103. Female connector only.
- 93 - Press-Fit, Compliant Termination size 16 and size 22 Straight Printed Board Mount for use with board thicknesses of 2.29 to 4.45 [0.090 to 0.175]. Connection system 1.
- 94 - Press-Fit, Compliant Termination size 16 and size 22 Straight Printed Board Mount for use with board thickness of 4.45 minimum [0.175 minimum]. Connection system 1.

STEP 5 - MOUNTING STYLE

- 0 - Standard Option

See page 105 for mounting screw options.

STEP 6 - HOODS

- 0 - Not applicable

STEP 9 - SPECIAL OPTIONS

FOR LISTING OF SPECIAL OPTIONS,
SEE SPECIAL OPTIONS APPENDIX
ON PAGES 111 AND 112.

STEP 8 - ENVIRONMENTAL COMPLIANCE OPTIONS

- /AA - RoHS Compliant

NOTE: If compliance to environmental legislation is not required, this step will not be used.
Example: PCIB26W11F9300A1

STEP 7 - CONTACT PLATING FOR PRINTED BOARD TYPE CONNECTORS

- 0 - Crimp contacts ordered separately
- A1 - Gold flash over nickel on mating end and termination end.
- A2 - Gold flash over nickel on mating end and 5.00µ [0.00020 inch] tin-lead solder coat on termination end. Not available with code 93 or code 94 in step 4.
- C1 - 0.76µ [0.000030 inch] gold over nickel on mating end and termination end.
- C2 - 0.76µ [0.000030 inch] gold over nickel on mating end and 5.00µ [0.00020 inch] tin-lead solder coat on termination end. Not available with code 93 or code 94 in step 4.
- D1 - 1.27µ [0.000050 inch] gold over nickel on mating end and termination end.
- D2 - 11.27µ [0.000050 inch] gold over nickel on mating end and 5.00µ [0.00020 inch] tin-lead solder coat on termination end. Not available with code 93 or code 94 in step 4.

NOTE: If you would like a 2D drawing or 3D model, once you've made your connector selection, please visit www.connectpositronic.com. If you can't find your specific part number on our web site, contact Technical Sales to have one created.

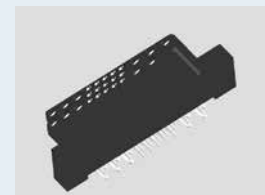
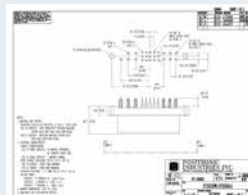

The PCIC Series encompasses all of the features of the PCIH Series in a **1U** package. Reliability, high current capacity and many system management connections make the PCIC Series ideal for use in telecom, computer, information systems and industrial applications.

PCIC SERIES CONTACT VARIANTS

FACE VIEW OF MALE AND REAR VIEW OF FEMALE

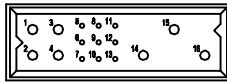

PCIC16W7 VARIANT

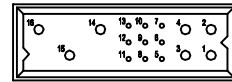

PCIC16W7R VARIANT (Inverted Termination)

7 Size 16 Power Contacts and 9 Size 22 Signal Contacts

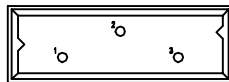

PCIC3W3 VARIANT

CREEPAGE AND CLEARANCE FOR
HIGH VOLTAGE APPLICATIONS

3 Size 16 Power Contacts





Positronic Industries
connectpositronic.com

TECHNICAL CHARACTERISTICS

Compact
Power
Connectors

MATERIALS AND FINISHES:

Insulator:	Glass-filled polyester, UL 94V-0, blue color.
Contacts:	Size 16 contacts: High conductivity precision-machined copper alloy. Size 22 contacts: Precision-machined copper alloy.
Plating:	Gold flash over nickel. Other plating options available, refer to Step 7 on page 101.
Mounting Screws:	Steel, zinc plated.
Jackscrows:	Stainless steel, passivated.

ELECTRICAL CHARACTERISTICS:

PCIC Contact Current Ratings, per UL 1977

See *Temperature Rise Curves* on page 6 for details.

PCIC3W3:

Size 16 Power Contacts:	32 amperes continuous, all contacts under load.
-------------------------	---

PCIC16W7:

Size 16 Power Contacts: Positions 14, 15, and 16:	40 amperes continuous, all contacts under load.
Positions 1 through 4:	30 amperes continuous, all contacts under load.
Size 22 Signal Contacts:	3 amperes nominal rating.

Initial Contact Resistance:

Size 16 Contact:	0.0007 ohms maximum.
Size 22 Contact:	0.005 ohms maximum. Per IEC 512-2, Test 2b.

Insulator Resistance:

5 G ohms per IEC 512-2, Test 3a.

Voltage Proof:

PCIC3W3: 5,000 V r.m.s.

PCIC16W7:

Contacts 14, 15, and 16:	3,000 V r.m.s.
Contacts 1 through 4:	1,500 V r.m.s.
Contacts 5 through 13:	1,000 V r.m.s.

Creepage and Clearance

Distance; minimum:

PCIC3W3: 7.23mm [0.285 inch]

PCIC16W7:

Contact 16 to Contact 14:	3.2mm [0.126 inch]
Contact 15 to Contact 14:	3.2mm [0.126 inch]
Contact 16 to Signal Contacts:	6.4mm [0.252 inch]
Contact 15 to Signal Contacts:	6.4mm [0.252 inch]
Contact 16 to Contact 15:	2.5mm [0.098 inch]
Contact 14 to Signal Contacts:	2.0mm [0.079 inch]

Working Voltage:

PCIC3W3: 2,000 V r.m.s.

PCIC16W7:

Contacts 14, 15 and 16:	1,000 V r.m.s.
Contacts 1 through 4:	500 V r.m.s.
Contacts 5 through 13:	333 V r.m.s.

MECHANICAL CHARACTERISTICS:

Blind Mating System:

Male and female connector bodies provide "lead-in" for 1.3mm [0.050 inch] diametral misalignment.

Polarization:

Provided by connector body design.

Removable Contacts:

Install contact from rear of insulator; release from front of insulator. Size 16 and 22 female contacts feature 0. "Closed Entry" design for highest reliability.

Removable Contact Retention in Connector Body:

Size 16 Contacts:

67 N [15 lbs.]

Size 22 Contacts:

27 N [6 lbs.]

Fixed Contacts:

Printed board terminations, both straight and right angle (90°). Size 16 female contacts feature "Closed Entry" design. Size 22 feature rugged "Open Entry" contact design. "Closed Entry" contacts available, consult Technical Sales.

Fixed Contact Retention in Connector Body:

Size 16 Contacts:

45 N [10 lbs.]

Size 22 Contacts:

27 N [6 lbs.]

Resistance to Solder Heat:

260°C [500°F] for 10 seconds duration per IEC 512-6, Test 12e, 25-watt soldering iron.

Sequential Contact Mating System:

PCIC16W7:

First mate contact 14 and last mate contact position 5.

Consult Technical Sales for customer specified sequential mating.

Safety "Recessed in Insulator" Contacts:

The following size 16 contacts are recessed 5mm [0.197 inch] below the face of the female connector insulator per safety requirements.

PCIC16W7:

Contact positions 15 and 16.

Compliant Terminations:

Size 16 and 22 contacts are available with Compliant Contact Terminations. Average insertion and extraction forces of size 16 contacts are 22N (5 lbs.) per contact.

Printed Board Mounting:

Mounting holes provided in connector body for printed board mounting. Self-tapping screws are available.

Mechanical Operations:

250 couplings, minimum.

CLIMATIC CHARACTERISTICS:

Working Temperature:

-55°C to +125°C.

U.L. Recognized File #E49351*1
CSA Recognized File #LR54219*1

*1 U.L. and CNR recognition for PCIC3W3 is pending, consult Technical Sales.

PCIC CONNECTOR OUTLINE DIMENSIONS

RIGHT ANGLE (90°) BOARD MOUNT CONNECTOR

FEMALE CONNECTOR

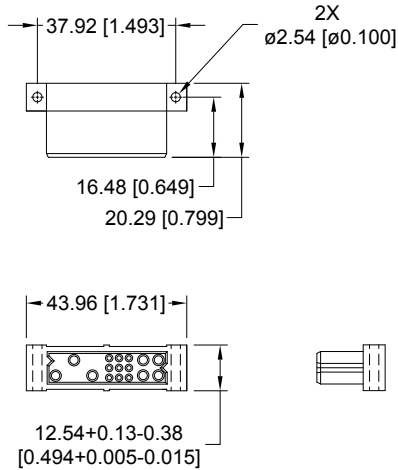

MALE CONNECTOR

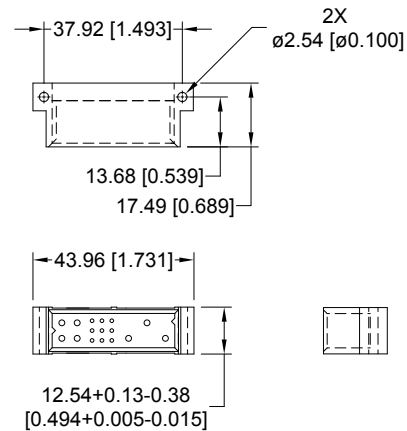

STRAIGHT BOARD MOUNT CONNECTOR

FEMALE CONNECTOR

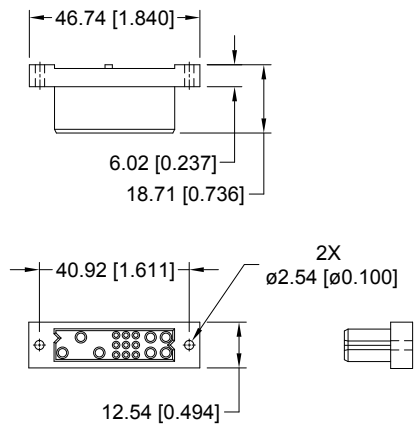

MALE CONNECTOR

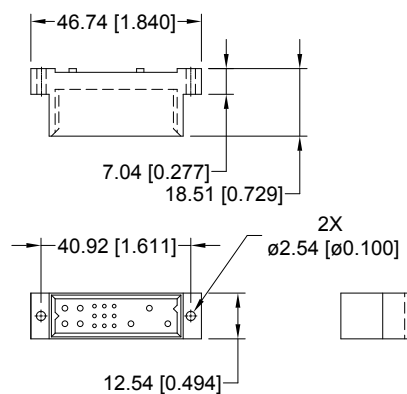

PCIC CONNECTOR MATING DIMENSIONS (FULLY MATED)

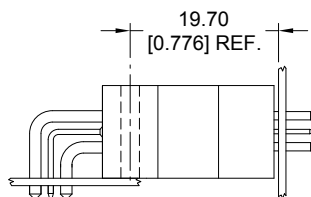

Right Angle (90°) Board
Mount Male to Straight
Board Mount or Panel
Mount Female

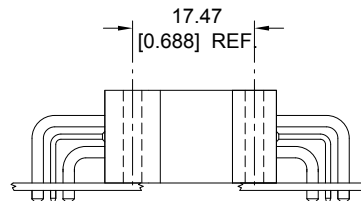

Right Angle (90°)
Board Mount Male to
Right Angle (90°)
Board Mount Female



STRAIGHT SOLDER CONNECTOR, FEMALE

FEMALE STRAIGHT SOLDER CONNECTOR CODE 3

STANDARD PART NUMBER
PCIC16W7F300A1

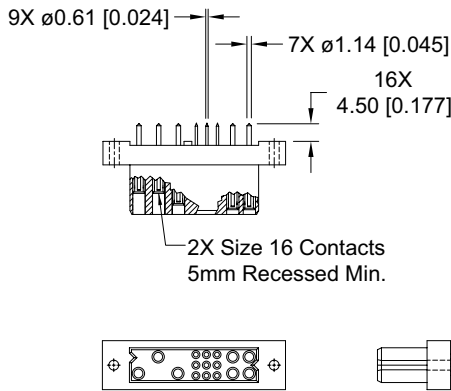

CONNECTOR DIMENSIONS

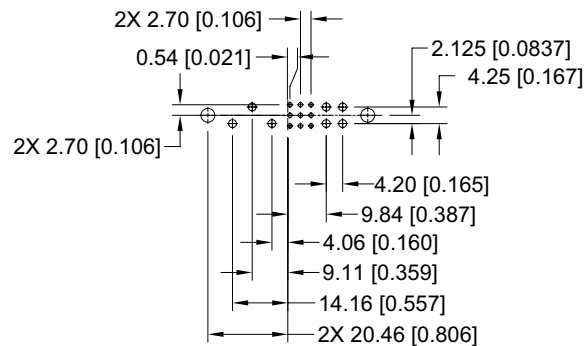

CONTACT HOLE PATTERN

Note: See below for suggested printed board hole sizes.

FEMALE STRAIGHT SOLDER CONNECTOR WITH A.C. PASS-THROUGH CODE 3 WITH MOS* -246.2

CRIMP CONTACTS ARE NOT SUPPLIED WITH CONNECTOR AND MUST BE ORDERED SEPARATELY

LOW PROFILE PART NUMBER
PCIC16W7F300A1-246.2

* For MOS descriptions,
see chart on pages 107-108.

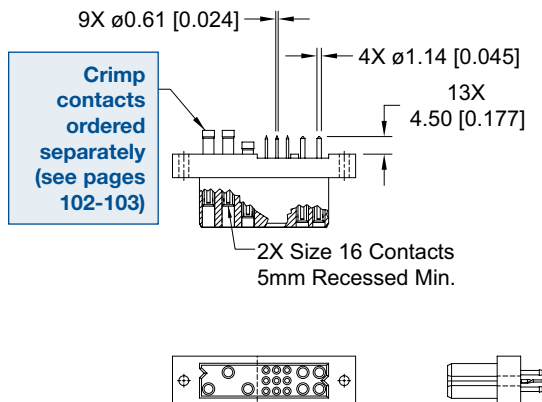

CONNECTOR DIMENSIONS

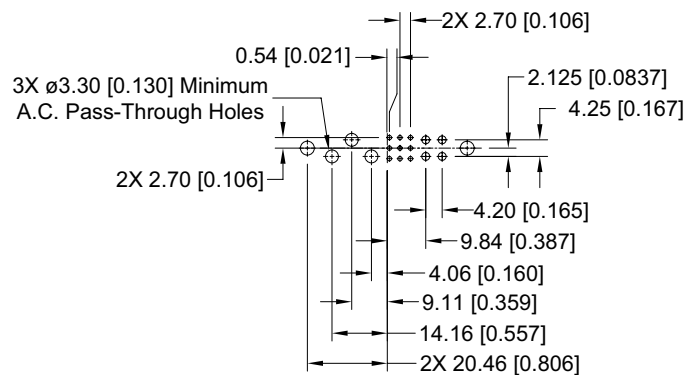

CONTACT HOLE PATTERN

SUGGESTED PRINTED BOARD HOLE SIZES:

Suggest $\phi 1.00$ [0.039] holes for size 22 contact holes.

Suggest $\phi 1.60$ [0.063] holes for size 16 contact holes.

Suggest $\phi 3.56 \pm 0.08$ [0.140 \pm 0.003] holes for connector mounting holes.

**MALE STRAIGHT SOLDER CONNECTOR
CODE 3**

**STANDARD PART NUMBER
PCIC16W7M300A1**

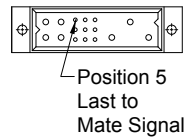
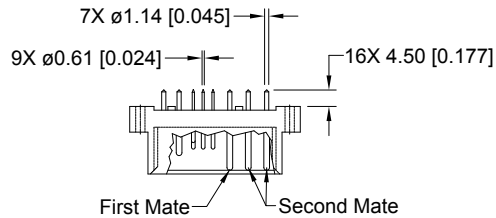

CONNECTOR DIMENSIONS

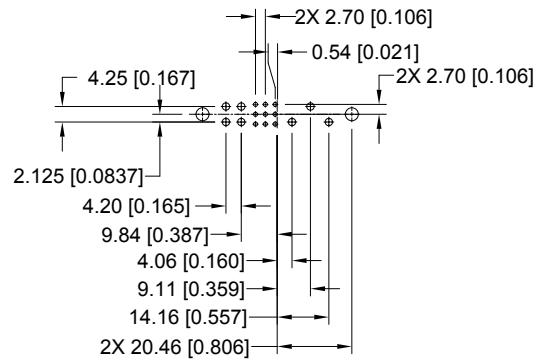

CONTACT HOLE PATTERN

Note: See below for suggested printed board hole sizes.

**MALE STRAIGHT SOLDER CONNECTOR WITH JACKSCREW SYSTEM
CODE 3 WITH MOS*1 -443.2**

**STANDARD PART NUMBER
PCIC3W3M300A1-443.2**

**1 For MOS descriptions,
see chart on pages 107-108.*

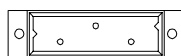
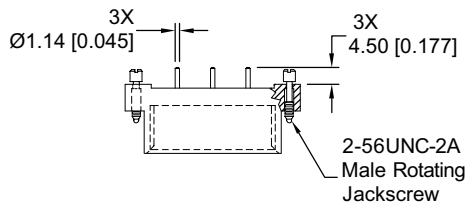

CONNECTOR DIMENSIONS

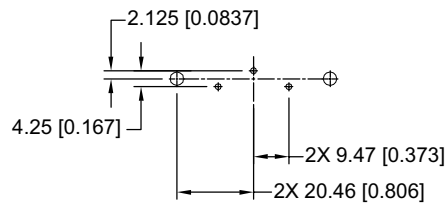

CONTACT HOLE PATTERN

SUGGESTED PRINTED BOARD HOLE SIZES:

Suggest Ø1.00 [0.039] holes for size 22 contact holes.
Suggest Ø1.60 [0.063] holes for size 16 contact holes.
Suggest Ø3.56±0.08 [0.140±0.003] holes for connector mounting holes.



Positronic Industries
connectpositronic.com

RIGHT ANGLE (90°) BOARD MOUNT CONNECTOR, FEMALE

Compact
Power
Connectors

PCIC SERIES

FEMALE RIGHT ANGLE (90°) BOARD MOUNT CONNECTOR CODE 4

STANDARD PART NUMBER
PCIC16W7F400A1

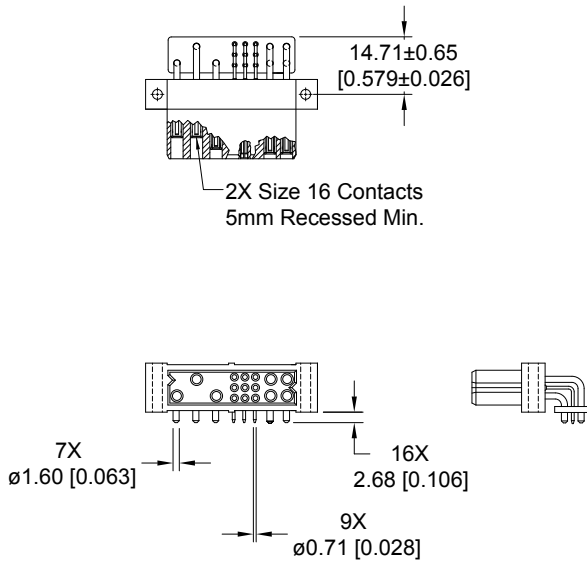

CONNECTOR DIMENSIONS

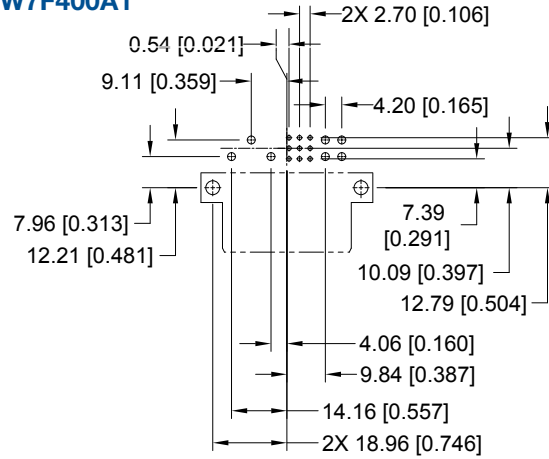

CONTACT HOLE PATTERN

Note: See below for suggested printed board hole sizes.

FEMALE RIGHT ANGLE (90°) BOARD MOUNT CONNECTOR CODE 4

PART NUMBER FOR INVERTED TERMINATION
PCIC16W7RF400A1

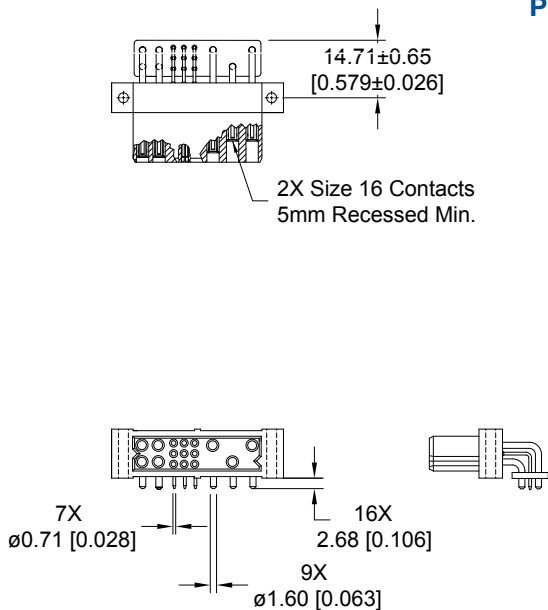

CONNECTOR DIMENSIONS

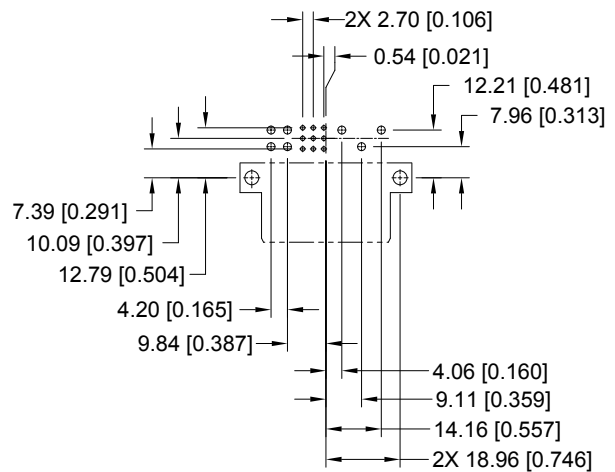

CONTACT HOLE PATTERN

SUGGESTED PRINTED BOARD HOLE SIZES:

Suggest Ø1.14 [0.045] holes for size 22 contact holes.

Suggest Ø2.03 [0.080] holes for size 16 contact holes.

Suggest Ø3.56±0.08 [0.140±0.003] holes for connector mounting holes.

**MALE RIGHT ANGLE (90°) BOARD MOUNT CONNECTOR
CODE 4**

**STANDARD PART NUMBER
PCIC16W7M400A1**

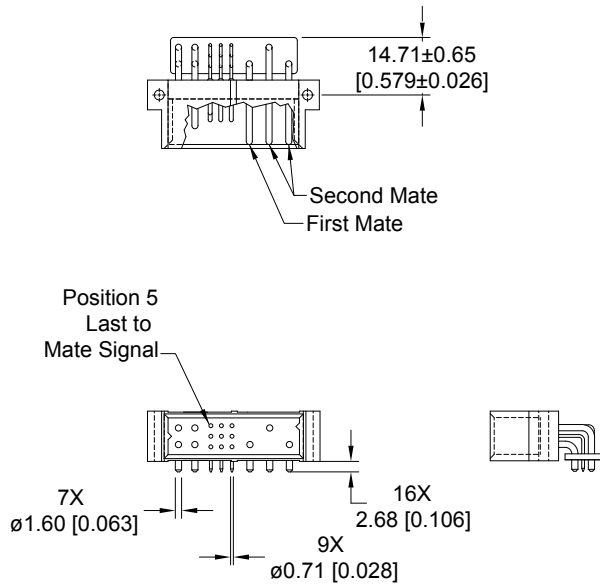

CONNECTOR DIMENSIONS

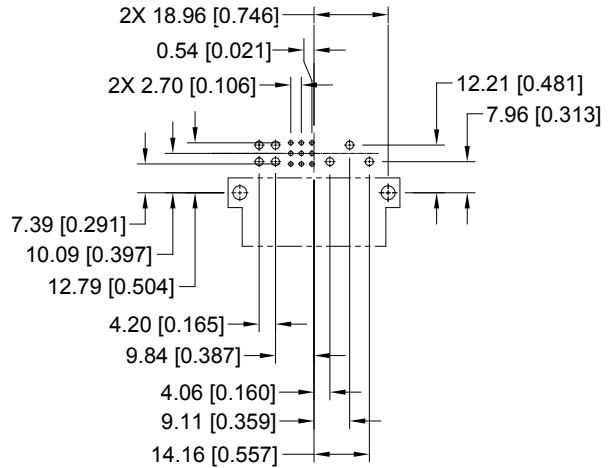

CONTACT HOLE PATTERN

Note: See below for suggested printed board hole sizes.

**MALE RIGHT ANGLE (90°) BOARD MOUNT CONNECTOR
CODE 4**

**PART NUMBER FOR INVERTED TERMINATION
PCIC16W7RM400A1**

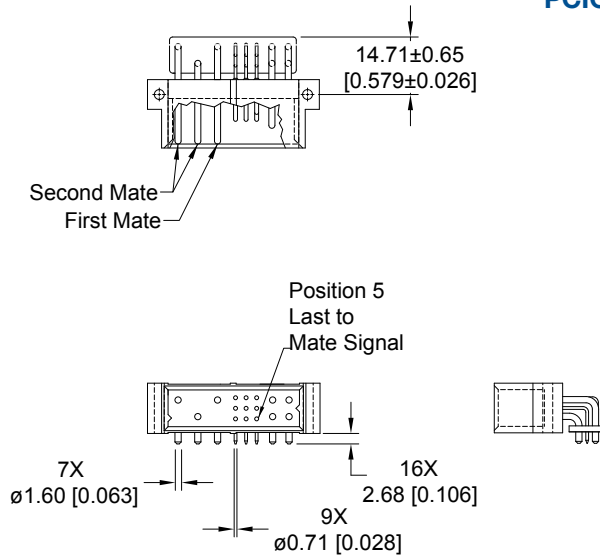

CONNECTOR DIMENSIONS

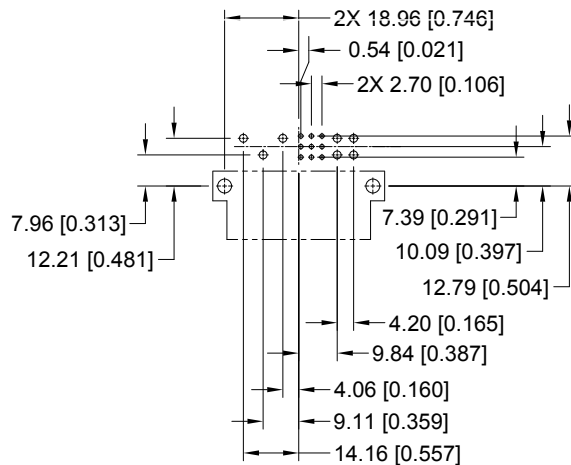

CONTACT HOLE PATTERN

SUGGESTED PRINTED BOARD HOLE SIZES:

- Suggest Ø1.14 [0.045] holes for size 22 contact holes.
- Suggest Ø2.03 [0.080] holes for size 16 contact holes.
- Suggest Ø3.56±0.08 [0.140±0.003] holes for connector mounting holes.



Positronic Industries
connectpositronic.com

PANEL MOUNT CONNECTOR. FEMALE

Compact
Power
Connectors

FEMALE PANEL MOUNT CRIMP CONTACT CONNECTOR CODE 8

CONTACTS ARE NOT SUPPLIED WITH CONNECTOR AND MUST BE ORDERED SEPARATELY

STANDARD PART NUMBER

PCIC16W7F8000

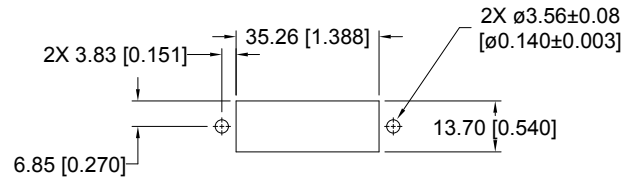
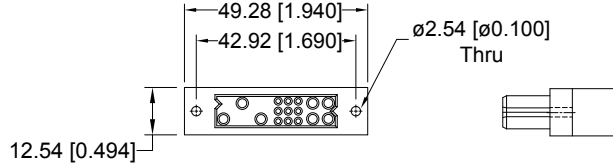
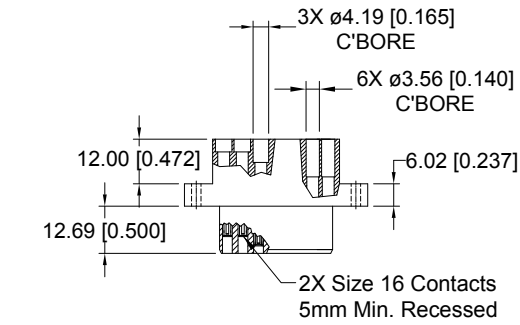

PANEL CUT OUT

CONNECTOR DIMENSIONS

For information regarding removable contacts, see Removable Contact section, pages 102-103.



FEMALE COMPLIANT PRESS-FIT CONNECTOR CODE 93 OR 94

STANDARD PART NUMBER
PCIC16W7F9300A1
PCIC16W7F9400A1

Positronic recommends the practice of using mounting hardware to secure connector to printed circuit board.

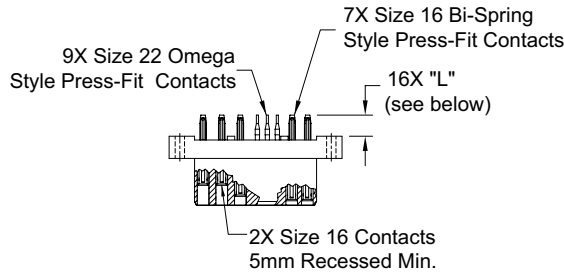

CONNECTOR DIMENSIONS

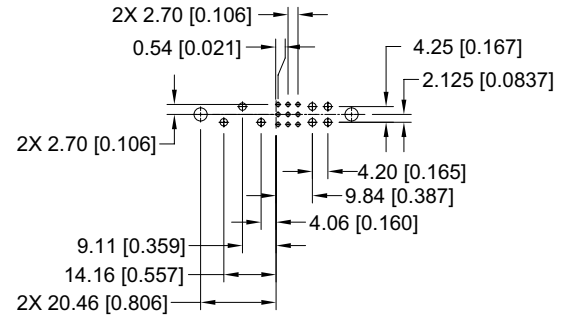

CONTACT HOLE PATTERN

CONTACT TAIL LENGTH

Code	"L" Length	Board Thickness
93	5.72 [0.225]	2.29 to 4.45 [0.090 to 0.175]
94	7.04 [0.277]	4.45 min. [0.175 min.]

Note: See below for suggested printed board hole sizes, press-fit connector installation tools, and mounting screw options.

FEMALE COMPLIANT PRESS-FIT CONNECTOR WITH A.C. PASS-THROUGH CODE 93 OR 94 WITH MOS*1 -246.2

CRIMP CONTACTS ARE NOT SUPPLIED WITH CONNECTOR AND MUST BE ORDERED SEPARATELY

LOW PROFILE PART NUMBER
PCIC16W7F9300A1-246.2
PCIC16W7F9400A1-246.2

*1 For MOS descriptions, see chart on pages 107-108.

Positronic recommends the practice of using mounting hardware to secure connector to printed circuit board.

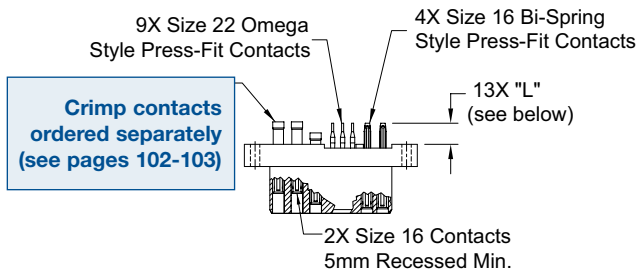

CONNECTOR DIMENSIONS

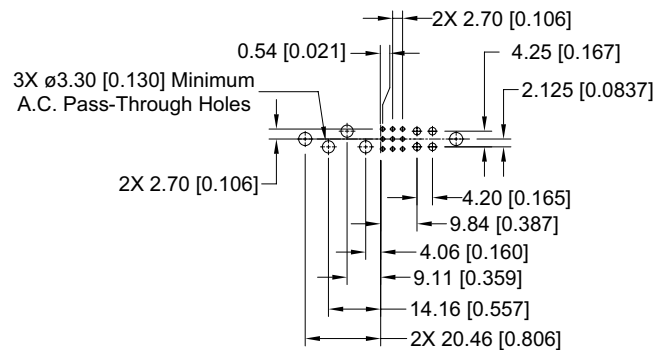

CONTACT HOLE PATTERN

CONTACT TAIL LENGTH

Code	"L" Length	Board Thickness
93	5.72 [0.225]	2.29 to 4.45 [0.090 to 0.175]
94	7.04 [0.277]	4.45 min. [0.175 min.]

SUGGESTED PRINTED BOARD HOLE SIZES:

Suggest $\varnothing 3.56 \pm 0.08$ [0.140 \pm 0.003] holes for connector mounting holes.

NOTE: See page 105 for suggested printed board drill hole sizes, recommended plating and finished hole sizes for compliant contact termination positions.

For press-fit connector installation tools, see pages 105-106.

For mounting screw options, see page 105.



Positronic Industries
connectpositronic.com

COMPLIANT PRESS-FIT BOARD MOUNT CONNECTOR, FEMALE

Compact
Power
Connectors

FEMALE COMPLIANT PRESS-FIT CONNECTOR WITH JACKSCREW SYSTEM CODE 93 OR 94 WITH MOS*1 -444.2

STANDARD PART NUMBER

PCIC3W3F9300A1-444.2

PCIC3W3F9400A1-444.2

*1 For MOS descriptions,
see chart on pages 107-108.

Positronic recommends the practice
of using mounting hardware to secure
connector to printed circuit board.

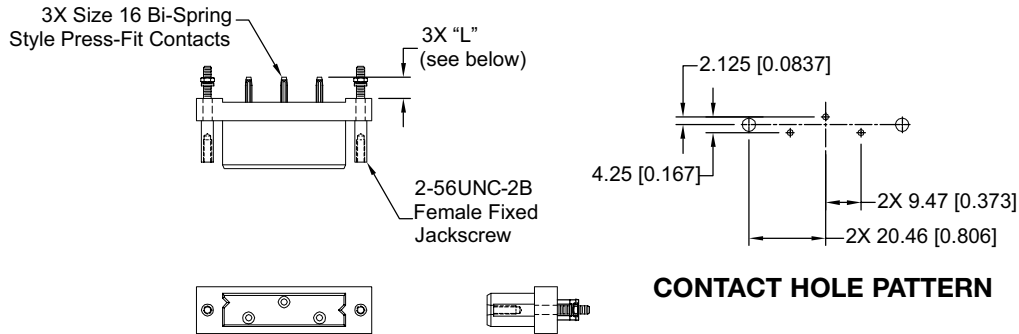

CONNECTOR DIMENSIONS

CONTACT HOLE PATTERN

CONTACT TAIL LENGTH		
Code	"L" Length	Board Thickness
93	5.72 [0.225]	2.29 to 4.45 [0.090 to 0.175]
94	7.04 [0.277]	4.45 min. [0.175 min.]

SUGGESTED PRINTED BOARD HOLE SIZES:

Suggest $\varnothing 3.56 \pm 0.08$ [0.140 \pm 0.003] holes for connector mounting holes.

NOTE: See page 105 for suggested printed board drill hole sizes, recommended plating and finished hole sizes for compliant contact termination positions.

For press-fit connector installation tools, see pages 105-106.

For mounting screw options, see page 105.

MALE COMPLIANT PRESS-FIT CONNECTOR
CODE 93 OR 94

STANDARD PART NUMBER

PCIC16W7M9300A1

PCIC16W7M9400A11

Positronic recommends the practice of using mounting hardware to secure connector to printed circuit board.

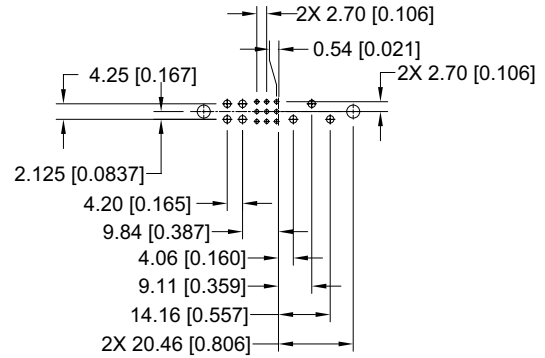
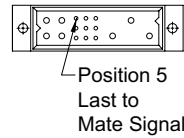
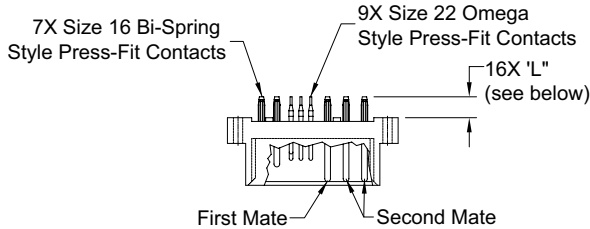

CONTACT HOLE PATTERN

CONNECTOR DIMENSIONS

CONTACT TAIL LENGTH		
Code	"L" Length	Board Thickness
93	5.72 [0.225]	2.29 to 4.45 [0.090 to 0.175]
94	7.04 [0.277]	4.45 min. [0.175 min.]

SUGGESTED PRINTED BOARD HOLE SIZES:

Suggest $\varnothing 3.56 \pm 0.08$ [0.140 \pm 0.003] holes for connector mounting holes.

NOTE: See page 105 for suggested printed board drill hole sizes, recommended plating and finished hole sizes for compliant contact termination positions.

For press-fit connector installation tools, see pages 105-106.

For mounting screw options, see page 105.



ORDERING INFORMATION - CODE NUMBERING SYSTEM

Specify Complete Connector By Selecting An Option From Step 1 Through 7

STEP	1	2	3	4	5	6	7	8	9
EXAMPLE	PCIC	16W7	F	93	0	0	A1	/AA	

STEP 1 - BASIC SERIES

PCIC - PCIC Series

STEP 2 - CONNECTOR VARIANTS

- 16W7 - 7 size 16 contacts and 9 size 22 contacts
- 16W7R - 7 size 16 contacts and 9 size 22 contacts. Inverted termination style, use with contact type "4".
- *13W3 - 3 size 16 contacts

STEP 3 - CONNECTOR GENDER

- F - Female
- M - Male

STEP 4 - CONTACT TERMINATION TYPE

- 3 - Solder, Straight Printed Board Mount with 4.50 [0.177] tail extension for connection systems 1 and 2.
- 4 - Solder, Right Angle (90°) Printed Board Mount with 2.68 [0.106] tail extension for connection systems 1 and 4.
- 8 - Contacts must be ordered separately for Panel Mount Cable Connectors, connection system 3, see pages 102-103. Female connector only.
- 93 - Press-Fit, Compliant Termination size 16 and size 22 Straight Printed Board Mount for use with board thicknesses of 2.29 to 4.45 [0.090 to 0.175]. Connection system 1.
- 94 - Press-Fit, Compliant Termination size 16 and size 22 Straight Printed Board Mount for use with board thickness of 4.45 minimum [0.175 minimum]. Connection systems 1 and 2.

STEP 5 - MOUNTING STYLE

- 0 - Standard Option
- See page 105 for mounting screw options.

STEP 6 - HOODS

- 0 - Not applicable

*1 PCIC3W3 variant only available in these part numbers: PCIC3W3F9300A1-444.2 and PCIC3W3M300A1-443.2. Consult Technical Sales for other options to this variant.

STEP 9 - SPECIAL OPTIONS

FOR LISTING OF SPECIAL OPTIONS, SEE SPECIAL OPTIONS APPENDIX ON PAGES 107 AND 108.

STEP 8 - ENVIRONMENTAL COMPLIANCE OPTIONS

- /AA - RoHS Compliant

NOTE: If compliance to environmental legislation is not required, this step will not be used.
Example: PCIC16W7F9300A1

STEP 7 - CONTACT PLATING FOR PRINTED BOARD TYPE CONNECTORS

- 0 - Crimp contacts ordered separately
- A1 - Gold flash over nickel on mating end and termination end.
- A2 - Gold flash over nickel on mating end and 5.00µ [0.00020 inch] tin-lead solder coat on termination end. Not available with code 93 or code 94 in step 4.
- C1 - 0.76µ [0.000030 inch] gold over nickel on mating end and termination end.
- C2 - 0.76µ [0.000030 inch] gold over nickel on mating end and 5.00µ [0.00020 inch] tin-lead solder coat on termination end. Not available with code 93 or code 94 in step 4.
- D1 - 1.27µ [0.000050 inch] gold over nickel on mating end and termination end.
- D2 - 11.27µ [0.000050 inch] gold over nickel on mating end and 5.00µ [0.00020 inch] tin-lead solder coat on termination end. Not available with code 93 or code 94 in step 4.

NOTE: If you would like a 2D drawing or 3D model, once you've made your connector selection, please visit www.connectpositronic.com. If you can't find your specific part number on our web site, contact Technical Sales to have one created.

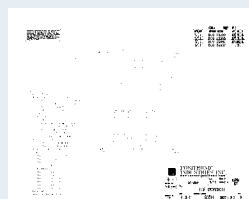



REMOVABLE CONTACT TECHNICAL CHARACTERISTICS

SIZE 22 REMOVABLE CONTACT

MATERIALS AND FINISHES:

Precision machined copper alloy with gold flash over nickel. Other finishes are available, see optional finishes for -14 and -15.

MECHANICAL CHARACTERISTICS:

Insert contact to rear face of insulator, release from front face of insulator. Female contact feature "Closed Entry" design for highest reliability.

ELECTRICAL CHARACTERISTICS:

Contact Current Rating: 3 amperes nominal.
Initial Contact Resistance: 0.004 ohms max. per IEC 512-2, test 2b.

SIZE 20 REMOVABLE CONTACT

MATERIALS AND FINISHES:

Precision machined copper alloy with gold flash over nickel. Other finishes are available, see optional finishes for -14 and -15.

MECHANICAL CHARACTERISTICS:

Insert contact to rear face of insulator, release from front face of insulator. Female contact feature "Closed Entry" design for highest reliability.

ELECTRICAL CHARACTERISTICS:

Contact Current Rating: 5 amperes nominal.
Initial Contact Resistance: 0.004 ohms max. per IEC 512-2, test 2b.

SIZE 16 REMOVABLE CONTACT

MATERIALS AND FINISHES:

HIGH CONDUCTIVITY: Tellurium copper, gold flash over nickel. Other finishes are available, see optional plating finishes for -14 and -15.

MECHANICAL CHARACTERISTICS:

Insert contact to rear face of insulator, release from front face of insulator. Female contact feature "Closed Entry" design for highest reliability.

ELECTRICAL CHARACTERISTICS:

Contact Current Rating: See Size 16 contact current ratings for individual variants:
PCIH - refer to page 13
PCIA - refer to page 38
PCIM - refer to pages 47-48
PCIB - refer to page 72
PCIC - refer to page 91
Initial Contact Resistance: 0.0007 ohms max. per IEC 512-2, test 2b.

OPTIONAL PLATING FINISHES

-14 0.000030 [0.76 μ] gold over nickel by adding "-14" suffix onto part number. *Example: FC720N2-14.*
-15 0.000050 inch [1.27 μ] gold over nickel by adding "-15". *Example: FC720N2-15.*

RoHS OPTIONS:

/AA Environmental Compliance Option (RoHS), compliant per EU Directive 2002/95/EC can be achieved by adding "/AA" suffix onto part number. *Examples: FC720N2/AA or for optional finishes use FC720N2/AA-14.*

REMOVABLE CRIMP CONTACT

FOR USE WITH PCIH, PCIA, PCIM, PCIB & PCIC SERIES PANEL MOUNT VERSION
CONTACTS MUST BE ORDERED SEPARATELY

SIZE 22

FEMALE CONTACT "CLOSED ENTRY" DESIGN

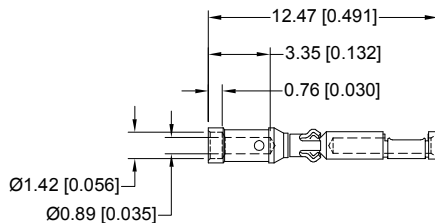

Part Number: FC422N8
Wire size 0.3 mm² [22 AWG]



What makes Positronic's new PosiBand® contact interface a significant improvement?

- Higher reliability in harsh environments and repeated mating cycles, and durability in blind mate applications
- More stable price over time
- No need to anneal PosiBand contacts eliminating possibility of incorrect annealing causing reliability problems on the mating end of the contact

For more information on PosiBand contacts, please contact Technical Sales.

For information regarding crimp tool and crimping tool techniques, see Application Tools section, pages 104-106.



REMOVABLE CONTACTS

REMOVABLE CRIMP CONTACT FOR USE WITH PCIH SERIES PANEL MOUNT VERSION CONTACTS MUST BE ORDERED SEPARATELY SIZE 20

FEMALE CONTACT "CLOSED ENTRY" DESIGN

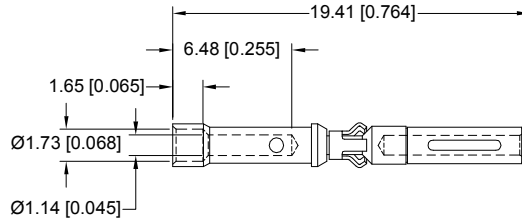

Part Number: **FC720N2**

Wire size 0.5-0.3-0.25 mm² [20-22-24 AWG]

REMOVABLE CRIMP CONTACT FOR USE WITH A.C. PASS-THROUGH AND PANEL MOUNT VERSIONS FOR PCIH, PCIA, PCIM, PCIB & PCIC SERIES CONNECTORS CONTACTS MUST BE ORDERED SEPARATELY SIZE 16

*FEMALE CONTACT*¹ "CLOSED ENTRY" DESIGN, L.S.A.

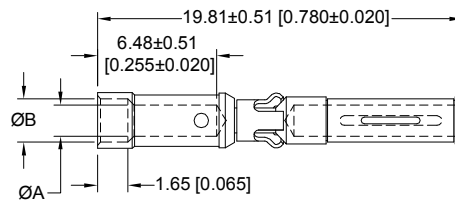

PART NUMBER	WIRE SIZE mm ² [AWG]	ØA	ØB
FC112N2S-1565.0	4.0 / [12]	2.49 [0.098]	n/a
To maintain current rating, FC112N2S-1565.0 must be used			
FC114N2-1565.0	2.5-1.5 / [14-16]	2.06 [0.081]	2.67 [0.105]
FC116N2-1565.0	1.5-1.0 / [16-18]	1.70 [0.067]	2.36 [0.093]
FC120N2-1565.0	0.5-0.3-0.25 / [20-22-24]	1.14 [0.045]	1.73 [0.068]

"S" in part number indicates high conductivity material.

These contact options do not feature high conductivity material and are for use with smaller than 12 awg wire. Contact resistance is 0.0016 ohms max. per IEC 512-2, test 2b.

*NOTE*¹: Female contacts feature Large Surface Area (L.S.A.) closed entry contact design which provides maximum mating surfaces between male and female contact and reduced contact resistance during operation.

For information regarding crimp tool and crimping tool techniques, see Application Tools section, pages 104-106.



A P P L I C A T I O N T O O L S S E C T I O N

PCIH / PCIA / PCIM / PCIB / PCIC connectors are offered with **removable**

crimp contacts. Positronic recognizes

the **importance of** supplying **application tooling**

to support our customers' use of our products.

Information on application tooling is

available on our web site at

<http://www.connectpositronic.com/tooling>

There you will find **downloadable PDF** cross reference

charts for removable and compliant press-in contacts. These charts

will **supply part numbers** for insertion, removal and crimping tools,

along with **information regarding use** of tools and techniques.





Positronic Industries
connectpositronic.com

COMPLIANT PRESS-FIT CONNECTORS PRINTED BOARD HOLE SIZES

Compact
Power
Connectors

SUGGESTED PRINTED BOARD HOLE SIZES FOR COMPLIANT PRESS-FIT CONNECTORS

Traditionally, tin-lead has been a popular plating for PBC holes. However, many PCB hole platings must now be RoHS Compliant. Positronic is pleased to offer **PCB HOLE SIZE FOR RoHS** PCB plating as shown below.

OMEGA & BI-SPRING COMPLIANT PRESS-FIT CONTACT HOLE				
BOARD TYPE	CONTACT SIZE / TYPE	RECOMMENDED DRILL HOLE SIZE	RECOMMENDED PLATING	FINISHED HOLE SIZES
TIN-LEAD SOLDER PCB	22 OMEGA	$\phi 1.150 \pm 0.025$ [$\phi 0.0453 \pm 0.0010$]	15 μ [0.0006] minimum solder over 25 μ [0.0010] min. copper	$\phi 1.000 + 0.090 - 0.060$ [$\phi 0.0394 + 0.0035 - 0.0024$]
	20 OMEGA	$\phi 1.150 \pm 0.025$ [$\phi 0.0453 \pm 0.0010$]		$\phi 1.000 + 0.090 - 0.060$ [$\phi 0.0394 + 0.0035 - 0.0024$]
	16 BI-SPRING	$\phi 1.750 \pm 0.025$ [$\phi 0.069 \pm 0.001$]		$\phi 1.600 + 0.090 - 0.060$ [$\phi 0.0630 + 0.0035 - 0.0024$]
RoHS PCB PLATING OPTIONS				
COPPER PCB	22 OMEGA	$\phi 1.19 \pm 0.025$ [$\phi 0.047 \pm 0.001$]	25 μ [0.0010] min. copper	$\phi 1.09 \pm 0.05$ [$\phi 0.043 \pm 0.002$]
	20 OMEGA	$\phi 1.19 \pm 0.025$ [$\phi 0.047 \pm 0.001$]		$\phi 1.09 \pm 0.05$ [$\phi 0.043 \pm 0.002$]
	16 BI-SPRING	$\phi 1.750 \pm 0.025$ [$\phi 0.069 \pm 0.001$]		$\phi 1.600 + 0.090 - 0.060$ [$\phi 0.0630 + 0.0035 - 0.0024$]
IMMERSION TIN PCB	22 OMEGA	$\phi 1.19 \pm 0.025$ [$\phi 0.047 \pm 0.001$]	0.85 \pm 0.15 μ [0.000033 \pm 0.000006] immersion tin over 25 μ [0.0010] min. copper	$\phi 1.09 \pm 0.05$ [$\phi 0.043 \pm 0.002$]
	20 OMEGA	$\phi 1.19 \pm 0.025$ [$\phi 0.047 \pm 0.001$]		$\phi 1.09 \pm 0.05$ [$\phi 0.043 \pm 0.002$]
	16 BI-SPRING	$\phi 1.750 \pm 0.025$ [$\phi 0.069 \pm 0.001$]		$\phi 1.600 + 0.090 - 0.060$ [$\phi 0.0630 + 0.0035 - 0.0024$]
IMMERSION SILVER PCB	22 OMEGA	$\phi 1.19 \pm 0.025$ [$\phi 0.047 \pm 0.001$]	0.34 \pm 0.17 μ [0.000013 \pm 0.000007] immersion silver over 25 μ [0.0010] min. copper	$\phi 1.09 \pm 0.05$ [$\phi 0.043 \pm 0.002$]
	20 OMEGA	$\phi 1.19 \pm 0.025$ [$\phi 0.047 \pm 0.001$]		$\phi 1.09 \pm 0.05$ [$\phi 0.043 \pm 0.002$]
	16 BI-SPRING	$\phi 1.750 \pm 0.025$ [$\phi 0.069 \pm 0.001$]		$\phi 1.600 + 0.090 - 0.060$ [$\phi 0.0630 + 0.0035 - 0.0024$]
ELECTROLESS NICKEL / IMMERSION GOLD PCB	22 OMEGA	$\phi 1.19 \pm 0.025$ [$\phi 0.047 \pm 0.001$]	0.05 μ [0.000002] min. immersion gold over 4.5 \pm 1.5 μ [0.000177 \pm 0.000059] electroless nickel per IPC-4552 over 25 μ [0.0010] min. copper	$\phi 1.09 \pm 0.05$ [$\phi 0.043 \pm 0.002$]
	20 OMEGA	$\phi 1.19 \pm 0.025$ [$\phi 0.047 \pm 0.001$]		$\phi 1.09 \pm 0.05$ [$\phi 0.043 \pm 0.002$]
	16 BI-SPRING	$\phi 1.750 \pm 0.025$ [$\phi 0.069 \pm 0.001$]		$\phi 1.600 + 0.090 - 0.060$ [$\phi 0.0630 + 0.0035 - 0.0024$]

Note: The PCIH38 variant contains size 16 and size 20 contacts. All other variants contain size 16 and size 22 contacts.

MOUNTING SCREWS

Stresses that occur during coupling and uncoupling of power supplies or through shock and vibration of systems can be transferred to backplanes or printed circuit boards through press-fit connector terminations. Avoid concern over electrical integrity of the connector to board interface by using mounting screws. Bellcore GR1217 details a preference for the use of mounting hardware and we recommend this practice.



ORDERING INFORMATION	
SCREW PART NUMBER	THREAD LENGTH
A2076-16-1-16	7.92+0.00-0.76 [0.312+0.000-0.030]
A2076-16-2-16	9.53+0.00-0.76 [0.375+0.000-0.030]
A2076-16-3-16	11.10+0.00-0.76 [0.437+0.000-0.030]
A2076-16-4-16	12.70+0.00-0.76 [0.500+0.000-0.030]

Screws are #4 self-tapping for plastic.

“Omega” Termination

utilized on signal contacts



“Bi-Spring” Termination

utilized on power contacts

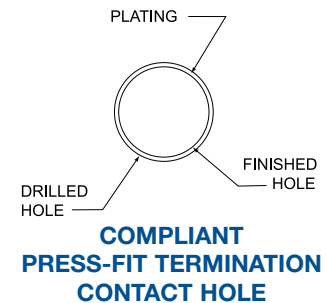

NOTE: For PCB plating compositions not shown, consult Technical Sales.

COMPLIANT PRESS-FIT USER INFORMATION

When properly used, Positronic Bi-Spring Power or Omega Signal Press-Fit terminations provide reliable service even under severe conditions.

Connectors utilizing this leading technology press-fit contact are easy to install:

1. Inexpensive installation tooling is available from Positronic, to choose the proper installation tool refer to page 106 for part number ordering information.
2. Insert the connector into the printed circuit board or backplane and seat connector fully.
3. Secure the connector to the printed circuit board or backplane using two self-tapping screws. The screws should be #4 self-tapping screws for plastic. Mounting screws can be ordered separately, see chart at the left.



COMPLIANT PRESS-FIT TERMINATION CONNECTOR INSTALLATION TOOLS

USE INDICATED POSITRONIC TOOLS FOR BEST RESULTS

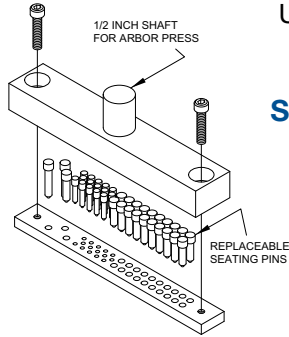

**SEATING
TOOL**

SUPPORT TOOL

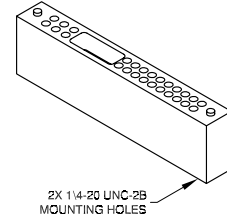

Positronic offers expert assistance in adapting application tooling to your manufacturing environment. Contact our application tooling specialist for assistance.

SERIES	CONNECTOR VARIANT	CONNECTOR SEATING TOOL WITH ARBOR PRESS SHAFT		CONNECTOR SEATING TOOL WITHOUT ARBOR PRESS SHAFT		REPLACEMENT PINS	CONNECTOR SUPPORT TOOL
		MALE	FEMALE	MALE	FEMALE	FEMALE	
PCIH	PCIH38	9513-300-13-41	9513-300-0-41	9513-300-33-41	9513-300-20-41	Positions 1 through 20: 855-347-2-0 Positions 21 through 35: 855-916-26-0 Position 36: 855-916-12-0 Positions 37 and 38: 855-916-11-0	9513-400-0-41
	PCIH47	9513-300-12-41	9513-300-3-41	9513-300-32-41	9513-300-23-41	Positions 1 through 20: 855-347-2-0 Positions 21 through 44: 855-916-19-0 Position 45: 855-916-12-0 Positions 46 and 47: 855-916-11-0	9513-400-0-41
	PCIH49W25 FEMALE -379.0 MALE -378.0	9513-300-12-41	9513-300-47-41	9513-300-32-41	9513-300-67-41	Positions 1 through 20: 855-347-2-0 Positions 21 through 44: 855-916-12-0 Position 45: 855-916-12-0 Positions 46 through 49: 855-916-11-0	9513-400-0-41
PCIA	PCIA60W36	9513-300-44-41	9513-300-9-41	9513-300-64-41	9513-300-29-41	Positions 1 through 30: 855-347-2-0 Positions 31 through 54: 855-916-19-0 Position 55 and 56: 855-916-12-0 Positions 57 through 60: 855-916-11-0	9513-400-2-41
PCIM	PCIM30W15	9513-300-52-41	9513-300-17-41	9513-300-72-41	9513-300-37-41	Positions 1 through 12: 855-347-2-0 Positions 13 through 27: 855-916-19-0 Position 28: 855-916-12-0 Positions 29 and 30: 855-916-11-0	9513-400-3-41
	PCIM33W18	9513-300-53-41	9513-300-40-41	9513-300-73-41	9513-300-60-41	Positions 1 through 12 and Positions 28 through 33: 855-347-2-0 Positions 13 through 27: 855-916-19-0	9513-400-3-41
	PCIM34W13	9513-300-54-41	9513-300-14-41	9513-300-74-41	9513-300-34-41	Positions 1 through 10: 855-347-2-0 Positions 11 through 31: 855-916-19-0 Position 32: 855-916-12-0 Positions 33 and 34: 855-916-11-0	9513-400-3-41
	PCIM37W16	9513-300-55-41	9513-300-41-41	9513-300-75-41	9513-300-61-41	Positions 1 through 10 and Positions 32 through 37: 855-347-2-0 Positions 11 through 31: 855-916-19-0	9513-400-3-41
PCIB	PCIB24W9	9513-300-50-41	9513-300-19-41	9513-300-70-41	9513-300-39-41	Positions 1 through 6: 855-347-2-0 Positions 7 through 21: 855-916-19-0 Position 22: 855-916-12-0 Position 23 and 24: 855-916-11-0	9513-400-4-41
	PCIB26W11	9513-300-49-41	9513-300-42-41	9513-300-69-41	9513-300-62-41	Positions 1 through 6 and Positions 22 through 26: 855-347-2-0 Positions 7 through 21: 855-916-19-0	9513-400-4-41
PCIC	PCIC16W7	9513-300-68-41	9513-300-43-41	9513-300-48-41	9513-300-63-41	Positions 1 through 4: 855-347-2-0 Positions 5 through 13: 855-916-19-0 Position 14: 855-916-12-0 Positions 15 and 16: 855-916-11-0	9513-400-5-41
	PCIC3W3	9513-300-56-41	9513-300-57-41	9513-300-76-41	9513-300-76-41	Positions 1 through 3: 855-347-2-0	9513-400-9-41



MODIFICATION OF STANDARD (MOS)

Specify complete connector by selecting a base part number from the desired series **Ordering Information Page**. Once base part number is selected, add desired modification of standard (MOS) number below to the end of the part number.

Example part number: PCIH47F9300A1/AA-245.0

(Ordering information pages can be found at the end of each series)

	CONNECTOR VARIANT SIZE	GENDER	TERMINATION TYPE AVAILABLE	MODIFICATION OF STANDARD (MOS) NUMBER	DESCRIPTION OF MODIFICATION
PCIH	38	F	3, 93, 94	-245.0	System 2, Straight Printed Board Mount 38 contact connector with 3 high profile A.C. pass-through contact positions.
	38	F	3, 93, 94	-246.1	System 2, Straight Printed Board Mount 38 contact connector with 3 low profile A.C. pass-through contact positions.
	47	F	3, 93, 94	-246.0	System 2, Straight Printed Board Mount 47 contact connector with 3 low profile A.C. pass-through contact positions.
	47 *47R	F	4	-246.4	System 5, Right Angle (90°) Board Mount 47 contact connector with 3 A.C. pass-through contact positions.
	47	M	4	259.0	Selectively loaded Right Angle (90°), 47 contact connector with ten total output contacts loaded in 1, 4, 5, 8, 9, 12, 13, 16, 19, 20. See page 11.
	47	M	4	259.1	Selectively loaded Right Angle (90°), 47 contact connector with six total output contacts loaded in 1, 5, 9, 13, 19, 20. See page 11.
	47	M	4	259.2	Selectively loaded Right Angle (90°), 47 contact connector with sixteen total output contacts loaded in 1, 3, 4, 5, 6, 7, 8, 9, 11, 12, 13, 15, 16, 17, 19, 20. See page 11.
	47	M	3, 4, 93, 94	-441.0	System 1 & 4, allows for any 47 male contact connector to be supplied with two additional contact positions, 48 and 49, to be left vacant in order to accept keying plugs. See page 7.
	47	F	3, 4, 93, 94	-442.0	System 1 & 4, allows for any 47 female contact connector to be supplied with two additional contact positions, 48 and 49, to be left vacant in order to accept keying plugs. See page 7.
	49W25	F	3, 93, 94	-246.3	System 2, Straight Printed Board Mount 49 contact connector with 5 low profile A.C. pass-through contact positions.
	49W25	M	3, 4, 93, 94	-378.0	Allows contacts 45-49 to be sequentially mated as follows: Position 45 is first mate, positions 46, 47, 48, and 49 are second mate. Male connector mates with female connector using MOS number -379.0.
	49W25 *49W25R	F	3, 4, 93, 94	-379.0	Allows for contact positions 46, 47, 48 and 49 to have 5mm recess. Contact 45 to have 2mm recess. Female connector mates with male connector using MOS number -378.0.

CONTACT TECHNICAL SALES FOR ADDITIONAL SPECIAL OPTIONS

*Inverted termination available on connectors with code 4 termination only.

Note: Select loading of contact positions are available, contact Technical Sales.



MODIFICATION OF STANDARD (MOS)

Specify complete connector by selecting a base part number from the desired series [Ordering Information Page](#). Once base part number is selected, add desired modification of standard (MOS) number below to the end of the part number.

Example part number: [PCIH47F9300A1/AA-245.0](#) (Ordering information pages can be found at the end of each series)

	CONNECTOR VARIANT SIZE	GENDER	TERMINATION TYPE AVAILABLE	MODIFICATION OF STANDARD (MOS) NUMBER	DESCRIPTION OF MODIFICATION
PCIA	Consult Technical Sales for Special Options				
PCIM	33W18	F	3, 93, 94	-246.10	System 2, Straight Printed Board Mount Connector with 3 low profile A.C pass-through contact positions.
PCIB	24W9	F	3, 93, 94	-246.5	System 2, Straight Printed Board Mount Connector with 3 low profile A.C pass-through contact positions.
	24W9 *24W9R	F	4	-422.0	System 1 and 4, Right Angle (90°) Printed Board Mount Connector with 3 low profile A.C pass-through contact positions.
	26W11	F	3, 93, 94	-246.6	System 2, Straight Printed Board Mount Connector with 5 low profile A.C pass-through contact positions.
	26W11	M	3, 93, 94	-444.0	Fixed jackscrew system. Male connector mates with female connector using MOS number -443.0
	26W11	F	8	-443.0	Rotating jackscrew system. Female connector mates with male connector using MOS number -444.0.
PCIC	16W7	F	3, 93, 94	-246.2	System 2, Straight Printed Board Mount Connector with 3 low profile A.C. Pass-Through contact positions.
	3W3	F	93, 94	-444.2	Special molding, fixed female jackscrews. Female connector mates with male connector using MOS number -443.2.
	3W3	M	3	-443.2	Special molding, special rotating male jackscrews. Male connector mates with female connector using MOS number -444.2.

CONTACT TECHNICAL SALES FOR ADDITIONAL SPECIAL OPTIONS

*Inverted termination available on connectors with code 4 termination only.

Connector Excellence[®]

Positronic HIGH RELIABILITY Products

POWER

FEATURES:



- High current density • Energy saving - low contact resistance • Hot swap capability
- AC/DC operation in a single connector
- Signal contacts for hardware management
- Blind mating • Sequential mating
- Large surface area contact mating system
- Wide variety of accessories
- Customer-specified contact arrangements
- Modular tooling which produces a single piece connector insert

Contact Sizes: 0, 8, 12, 16, 20, 22 and 24
Current Ratings: To 200 amperes per contact
Terminations: Crimp and panel mount, straight solder, right angle (90°) solder, straight compliant press-in and right angle (90°) compliant press-in
Configurations: Multiple variants in a variety of package sizes
Compliance: PICMG 2.11, PICMG 3.0, VITA 41, DSCC, GSFC S-311-P-4, GSFC S-311-P-10

D - SUB MINIATURE

FEATURES:



- Four performance levels available for best cost/performance ratio: professional, industrial, military and space-flight quality
- Options include high voltage, coax, thermocouple and air coupling contacts; environmentally sealed and dual port connector packages including mixed density
- Broad selection of accessories
- Size 20 and 22 contacts suitable for use in carrying power
- IP65, IP67

Contact Sizes: 8, 16, 20 and 22
Current Ratings: To 100 amperes
Terminations: Crimp, wire solder, straight solder, right angle (90°) solder, straight compliant press-in and right angle (90°) compliant press-in
Configurations: Multiple variants in both standard and high densities, seven shell sizes
Qualifications: MIL-DTL-24308, GSFC S-311-P-4, GSFC S-311-P-10, SAE AS39029, DSCC

RECTANGULAR

FEATURES:



- Two performance levels available: industrial quality and military quality
- A wide variety of accessories
- Broad selection of contact variants and package sizes
- Connector keying options

Contact Sizes: 16, 20 and 22
Current Ratings: To 13 amperes nominal
Terminations: Crimp, wire solder, straight solder, right angle (90°) solder, and straight compliant press-in
Configurations: Multiple variants in both standard and high densities, thirty package sizes
Qualifications: MIL-DTL-28748, SAE AS39029, CCITT V.35

CIRCULAR

FEATURES:



- Non-corrodible / lightweight composite construction
- EMI/RFI shielded versions
- Thermocouple contacts
- Environmentally sealed versions
- Rear insertion/ front release of removable contacts
- Two level sequential mating
- Overmolding available on full assemblies

Contact Sizes: 12, 16, 20 and 22
Current Ratings: To 25 amperes nominal
Terminations: Crimp, wire solder, straight solder, and right angle (90°) solder
Configurations: Multiple variants in four package sizes
Qualifications: Environmental protection to IP67

CABLE

FEATURES:



- Shorten the supply chain and reduce additional costs and delays by "cablizing" your Positronic connector selection
- Overmolding available
- Shielded and environmentally sealed versions available
- Power cables and access boxes which meet the SAE J2496 specification

- 3 Design assemblies in accordance with customer specifications.
- 3 Prepare cablized connector configuration and performance specifications.
- 3 Design each system in accordance with applicable customer, domestic, and international standards.
- 3 Define and conduct performance and verification testing.

HERMETIC

FEATURES:



- Intended for use as an electrical feedthrough in high vacuum applications
- Leakage rate: 5 x 10⁻⁹ mbar.l/s @ vacuum 1.5 x 10⁻⁵ atm
- Signal, power, coax and high voltage versions available
- Connectors can be mounted on flange assembly per customer specification

Contact Sizes: 8, 12, 16, 20 and 22
Current Ratings: To 40 amperes nominal
Terminations: Feedthrough is standard; flying leads and board mount available upon request
Configurations: See D-subminiature and circular configurations above
Compliance: Space-D32



Positronic[®]

an **Amphenol** company

Divisional Headquarters

Positronic | Americas

1325 N Eldon Ave
Springfield MO 65803 USA

+1 800 641 4054
info@connectpositronic.com

Positronic | Europe

Z.I. d'Engachies
46, route d'Engachies
F-32020 Auch Cedex 9 France

+33 5 6263 4491
contact@connectpositronic.com

Positronic | Asia

3014A Ubi Rd 1 #07-01
Singapore 408703

+65 6842 1419
singapore@connectpositronic.com

Sales Offices

Positronic has local sales representation all over the world. To find the nearest sales office, please visit www.connectpositronic.com/sales